CHAPTER 3

The Experimental Basis of Quantum Theory

- 3.1 Discovery of the X Ray and the Electron
- 3.2 Determination of Electron Charge
- 3.3 Line Spectra
- 3.4 Quantization
- 3.5 Blackbody Radiation
- 3.6 Photoelectric Effect
- 3.7 X-Ray Production
- 3.8 Compton Effect
- 3.9 Pair Production and Annihilation

As far as I can see, our ideas are not in contradiction to the properties of the photoelectric effect observed by Mr. Lenard.

- Max Planck, 1905

3.1: Discovery of the X Ray and the Electron

- X rays were discovered by Conrad Wilhelm Röntgen in 1895.
 - Observed x rays emitted by cathode rays bombarding glass.
- Electrons were discovered by J. J. Thomson in 1897.
 - Observed that cathode rays were charged particles.

Cathode Ray Experiments

- In the 1890s scientists and engineers were familiar with “cathode rays”. These rays were generated from one of the metal plates in an evacuated tube across which a large electric potential had been established.
- It was surmised that cathode rays had something to do with atoms.
- It was known that cathode rays could penetrate matter and were deflected by magnetic and electric fields.

Observation of X Rays

- Wilhelm Röntgen studied the effects of cathode rays passing through various materials. He noticed that a phosphorescent screen near the tube glowed during some of these experiments. These rays were unaffected by magnetic fields and penetrated materials more than cathode rays.
- He called them **x rays** and deduced that they were produced by the cathode rays bombarding the glass walls of his vacuum tube.

Röntgen's X Ray Tube

- Röntgen constructed an x-ray tube by allowing cathode rays to impact the glass wall of the tube and produced x rays. He used x rays to image the bones of a hand on a phosphorescent screen.

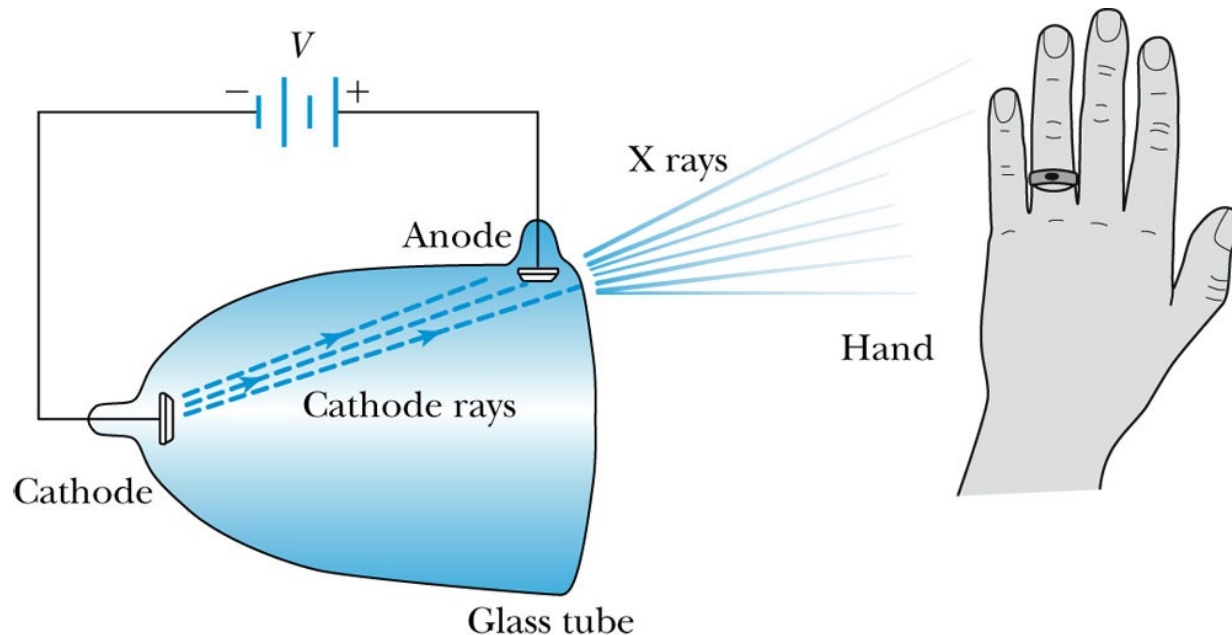

© 2006 Brooks/Cole - Thomson

Apparatus of Thomson's Cathode-Ray Experiment

- Thomson used an evacuated cathode-ray tube to show that the cathode rays were negatively charged particles (electrons) by deflecting them in electric and magnetic fields.

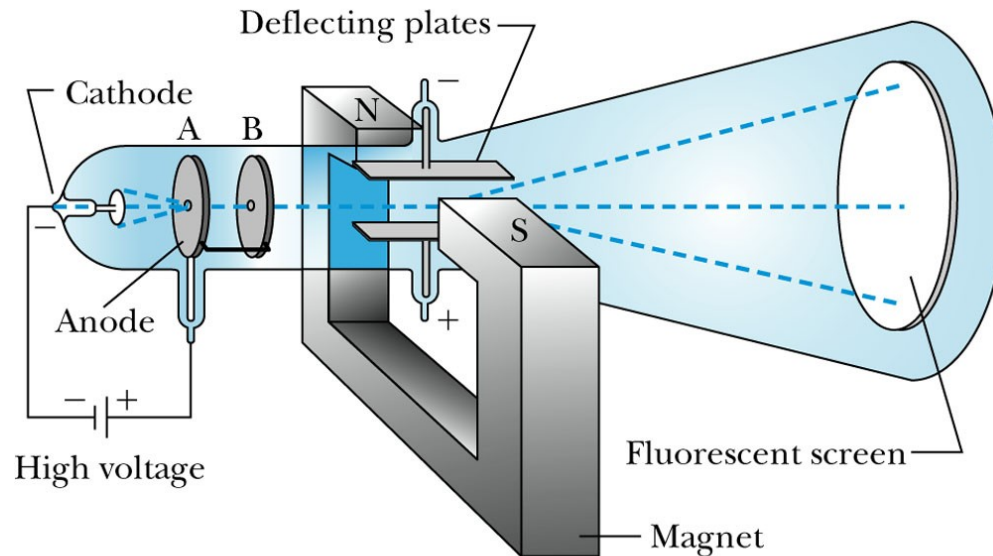

© 2006 Brooks/Cole - Thomson

Thomson's Experiment

- Thomson's method of measuring the ratio of the electron's charge to mass was to send electrons through a region containing a magnetic field perpendicular to an electric field.

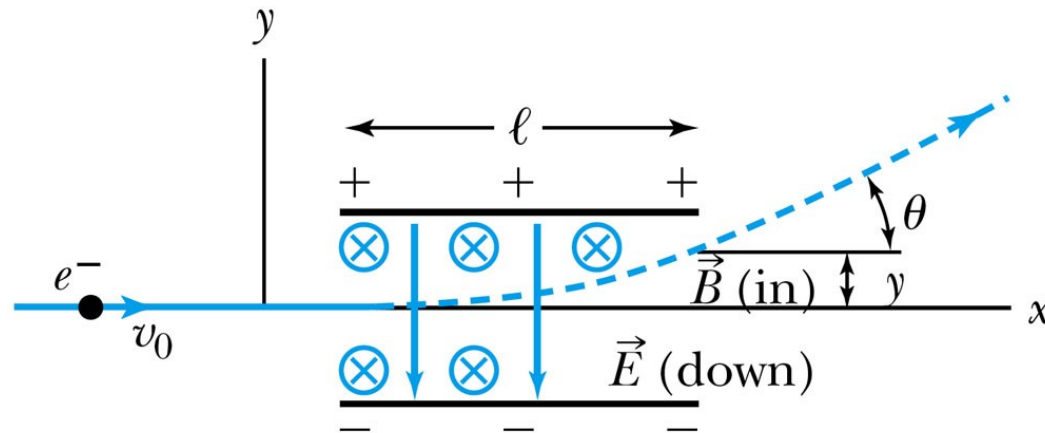

© 2006 Brooks/Cole - Thomson

Calculation of e/m

- An electron moving through the electric field is accelerated by a force: $F_y = ma_y = qE$

- Electron angle of deflection: $\tan \theta = \frac{v_y}{v_x} = \frac{a_y t}{v_0} = \frac{qE}{m} \frac{\ell}{v_0^2}$

- The magnetic field deflects the electron against the electric field force. $\vec{F} = q\vec{E} + q\vec{v} \times \vec{B} = 0$

- The magnetic field is adjusted until the net force is zero.

$$\vec{E} = -\vec{v} \times \vec{B} \qquad v = \frac{|\vec{E}|}{|\vec{B}|} = v_0$$

- Charge to mass ratio: $\frac{q}{m} = \frac{v_0^2 \tan \theta}{E \ell} = \frac{E \tan \theta}{B^2 \ell}$

3.2: Determination of Electron Charge

Millikan oil drop experiment

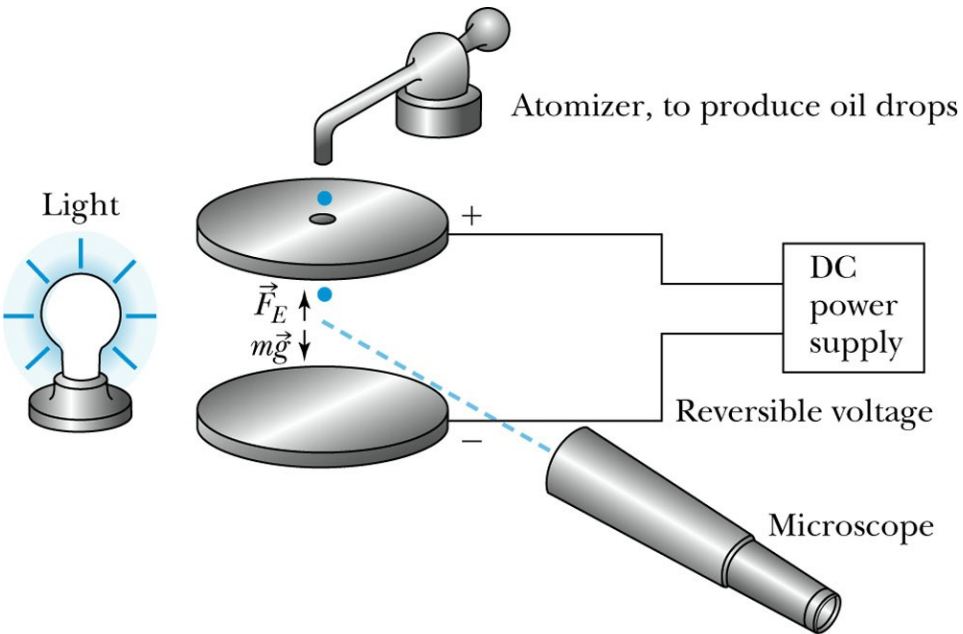

(a)

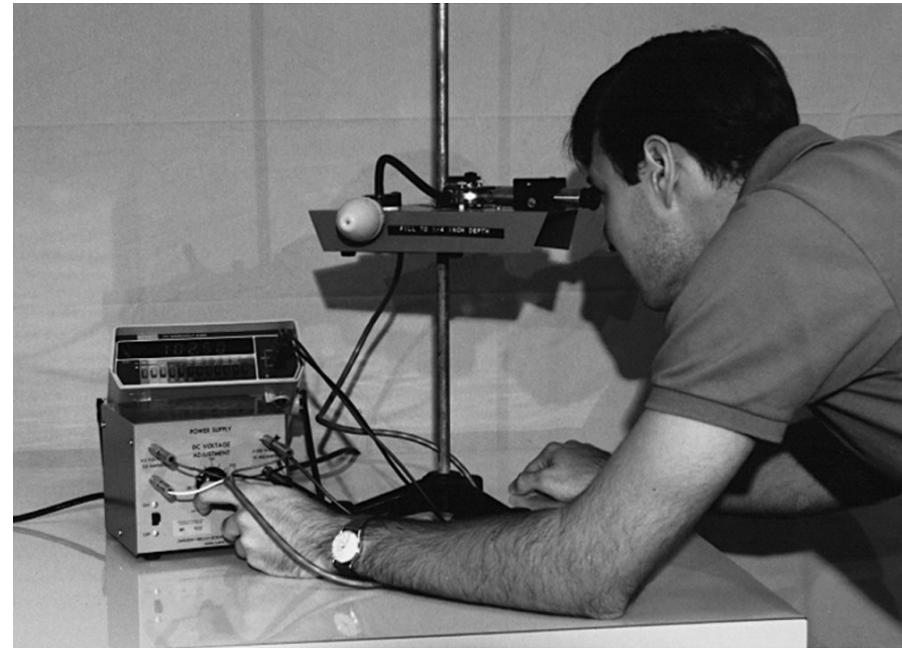

© 2006 Wadsworth - Thomson

Calculation of the oil drop charge

- Used an electric field and gravity to suspend a charged oil drop.

$$\vec{F}_y = q\vec{E} = -m\vec{g}$$

- Mass is determined from Stokes's relationship of the terminal velocity to the radius and density.

$$m = \frac{4}{3}\pi r^3 \rho$$

- Magnitude of the charge on the oil drop.

$$q = \frac{mgd}{V}$$

- Thousands of experiments showed that there is a basic quantized electron charge.

$$q = 1.602 \times 10^{-19} \text{ C}$$

3.3: Line Spectra

- Chemical elements were observed to produce unique wavelengths of light when burned or excited in an electrical discharge.
- Emitted light is passed through a diffraction grating with thousands of lines per ruling and diffracted according to its wavelength λ by the equation:

$$d \sin \theta = n\lambda$$

where d is the distance of line separation and n is an integer called the order number.

Optical Spectrometer

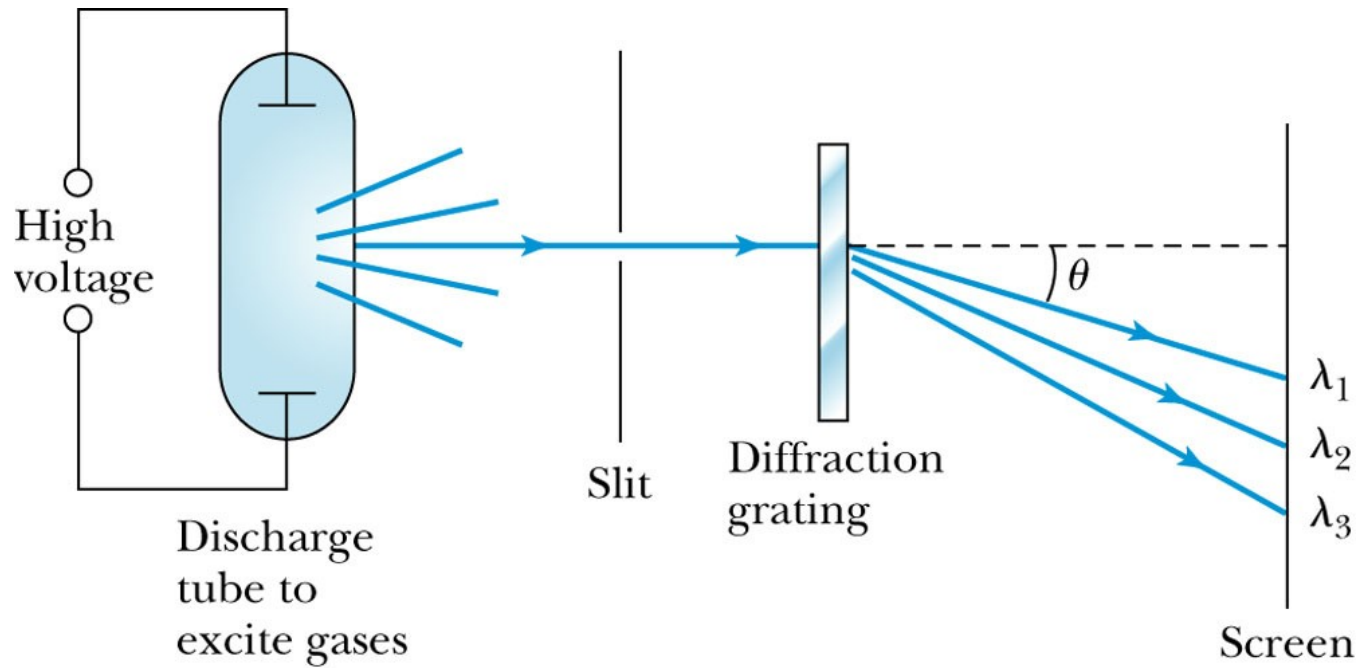

© 2006 Brooks/Cole - Thomson

- Diffraction creates a *line spectrum* pattern of light bands and dark areas on the screen.
- The line spectrum serves as a fingerprint of the gas that allows for unique identification of chemical elements and material composition.

Balmer Series

- In 1885, Johann Balmer found an empirical formula for wavelength of the visible hydrogen line spectra in nm:

$$\lambda = 364.56 \frac{k^2}{k^2 - 4} \text{ nm} \quad (\text{where } k = 3, 4, 5, \dots)$$

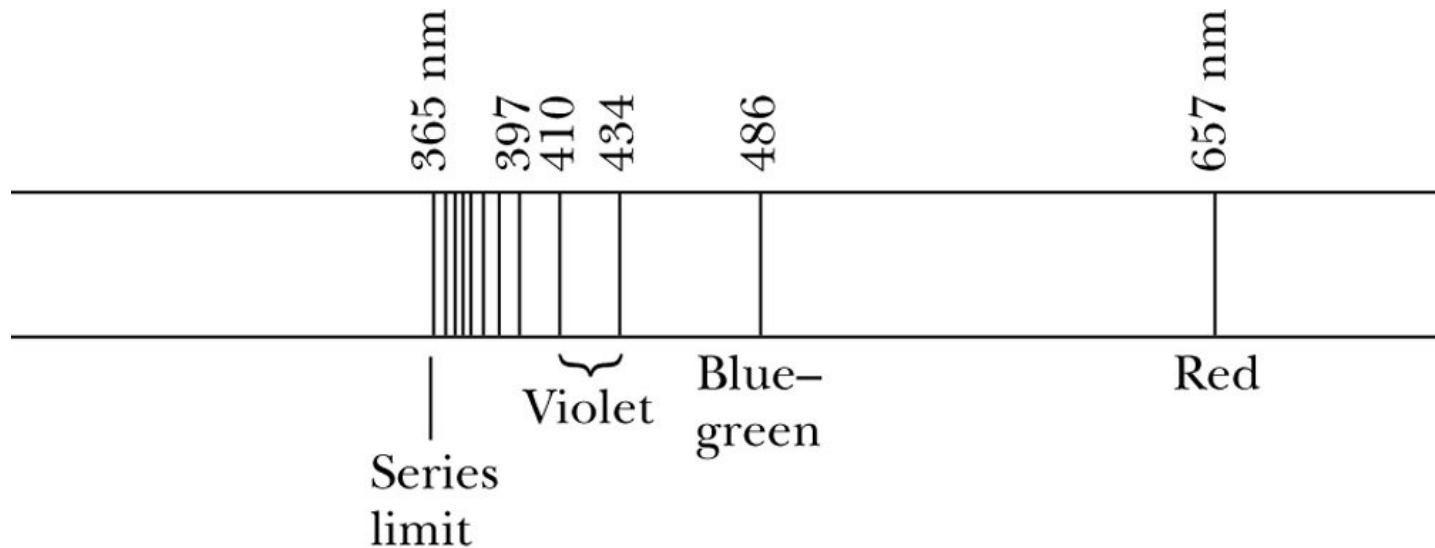

Rydberg Equation

- As more scientists discovered emission lines at infrared and ultraviolet wavelengths, the Balmer series equation was extended to the Rydberg equation:

$$\frac{1}{\lambda} = R_H \left(\frac{1}{n^2} - \frac{1}{k^2} \right) \quad R_H = 1.096776 \times 10^7 \text{ m}^{-1}$$

Table 3.2 Hydrogen Series of Spectral Lines

Discoverer (year)	Wavelength	n	k
Lyman (1916)	Ultraviolet	1	>1
Balmer (1885)	Visible, ultraviolet	2	>2
Paschen (1908)	Infrared	3	>3
Brackett (1922)	Infrared	4	>4
Pfund (1924)	Infrared	5	>5

3.4: Quantization

- Current theories predict that charges are quantized in units (called **quarks**) of $e/3$ and $2e/3$, but quarks are not directly observed experimentally. The charges of particles that have been directly observed are quantized in units of e .
- The measured atomic weights are not continuous—they have only discrete values, which are close to integral multiples of a unit mass.

3.5: Blackbody Radiation

- When matter is heated, it emits radiation.
- A blackbody is a cavity in a material that only emits thermal radiation. Incoming radiation is absorbed in the cavity.

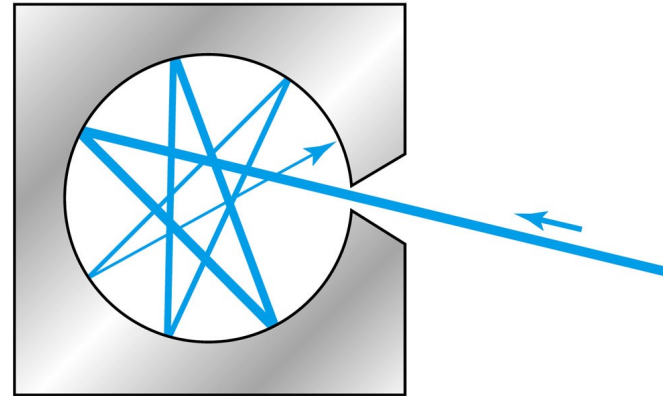

© 2008 Brooks/Cole - Thomson

- Blackbody radiation is theoretically interesting because the radiation properties of the blackbody are independent of the particular material. Physicists can study the properties of intensity versus wavelength at fixed temperatures.

Wien's Displacement Law

- The intensity $\mathcal{I}(\lambda, T)$ is the total power radiated per unit area per unit wavelength at a given temperature.
- **Wien's displacement law:** The maximum of the distribution shifts to smaller wavelengths as the temperature is increased.

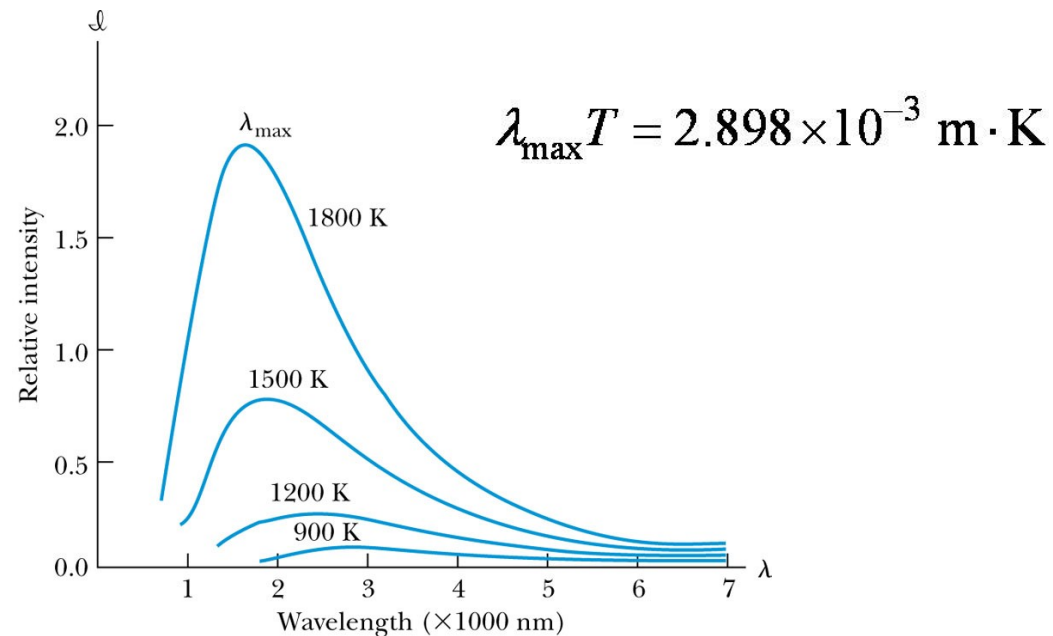

© 2006 Brooks/Cole - Thomson

Stefan-Boltzmann Law

- The total power radiated increases with the temperature:

$$R(T) = \int_0^{\infty} \mathcal{L}(\lambda, T) d\lambda = \epsilon \sigma T^4$$

- This is known as the **Stefan-Boltzmann law**, with the constant σ experimentally measured to be $5.6705 \times 10^{-8} \text{ W / (m}^2 \cdot \text{K}^4)$.
- The **emissivity** ϵ ($\epsilon = 1$ for an idealized blackbody) is simply the ratio of the emissive power of an object to that of an ideal blackbody and is always less than 1.

Rayleigh-Jeans Formula

- Lord Rayleigh (John Strutt) and James Jeans used the classical theories of electromagnetism and thermodynamics to show that the blackbody spectral distribution should be

$$u(\lambda, T) = \frac{2\pi ckT}{\lambda^4} \quad u(f, T) = \frac{8\pi f^2 kT}{c^3}$$

$$u(f, T) = \frac{8\pi f^3}{c^3} \cdot \frac{1}{\exp(hf/kT) - 1} \approx \frac{8\pi f^3}{c^3} \cdot \frac{1}{1 + (hf/kT) - 1}$$

$\exp(x) \approx 1 + x$ for very small x , i.e. when $h \rightarrow 0$, d. h. classical physics (also for f small and T large)

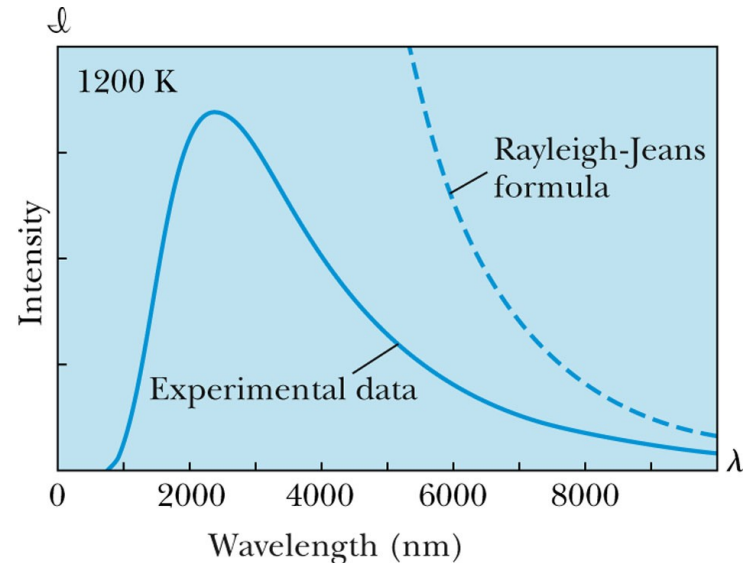

© 2006 Brooks/Cole - Thomson

- It approaches the data at longer wavelengths, but it deviates badly at short wavelengths. This problem for small wavelengths became known as “the ultraviolet catastrophe” and was one of the outstanding exceptions that classical physics could not explain.

Planck's Radiation Law

- Planck assumed that the radiation in the cavity was emitted (and absorbed) by some sort of “oscillators” that were contained in the walls. He used Boltzmann’s statistical methods to arrive at the following formula that fit the blackbody radiation data.

$$I(\lambda, T) = \frac{2\pi c^2 h}{\lambda^5} \frac{1}{e^{hc/\lambda kT} - 1} \quad \text{Planck's radiation law}$$

- Planck made two modifications to the classical theory:
 - The oscillators (of electromagnetic origin) can only have certain discrete energies determined by $E_n = nhf$, where n is an integer, f is the frequency, and h is called Planck’s constant.
 $h = 6.6261 \times 10^{-34} \text{ J}\cdot\text{s}$.
 - The oscillators can absorb or emit energy in discrete multiples of the fundamental quantum of energy given by

$$\Delta E = hf$$

3.6: Photoelectric Effect

Methods of electron emission:

- Thermionic emission: Application of heat allows electrons to gain enough energy to escape.
- Secondary emission: The electron gains enough energy by transfer from another high-speed particle that strikes the material from outside.
- Field emission: A strong external electric field pulls the electron out of the material.
- Photoelectric effect: Incident light (electromagnetic radiation) shining on the material transfers energy to the electrons, allowing them to escape.

Electromagnetic radiation interacts with electrons within metals and gives the electrons increased kinetic energy. Light can give electrons enough extra kinetic energy to allow them to escape. We call the ejected electrons **photoelectrons**.

Experimental Setup

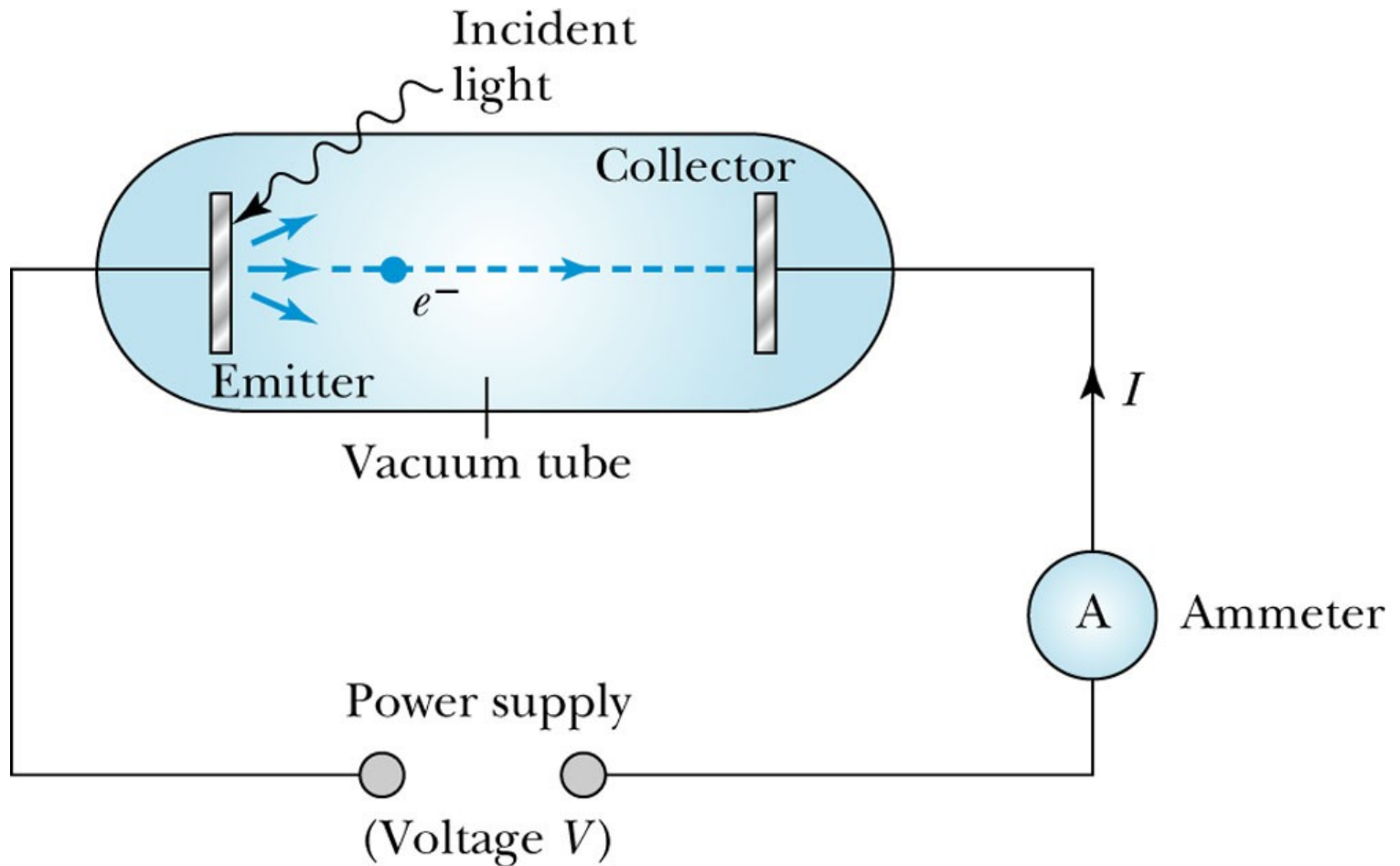

Experimental Results

- 1) The kinetic energies of the photoelectrons are independent of the light intensity.
- 2) The maximum kinetic energy of the photoelectrons, for a given emitting material, depends only on the frequency of the light.
- 3) The smaller the work function ϕ of the emitter material, the smaller is the threshold frequency of the light that can eject photoelectrons.
- 4) When the photoelectrons are produced, however, their number is proportional to the intensity of light.
- 5) The photoelectrons are emitted almost instantly following illumination of the photocathode, independent of the intensity of the light.

Experimental Results

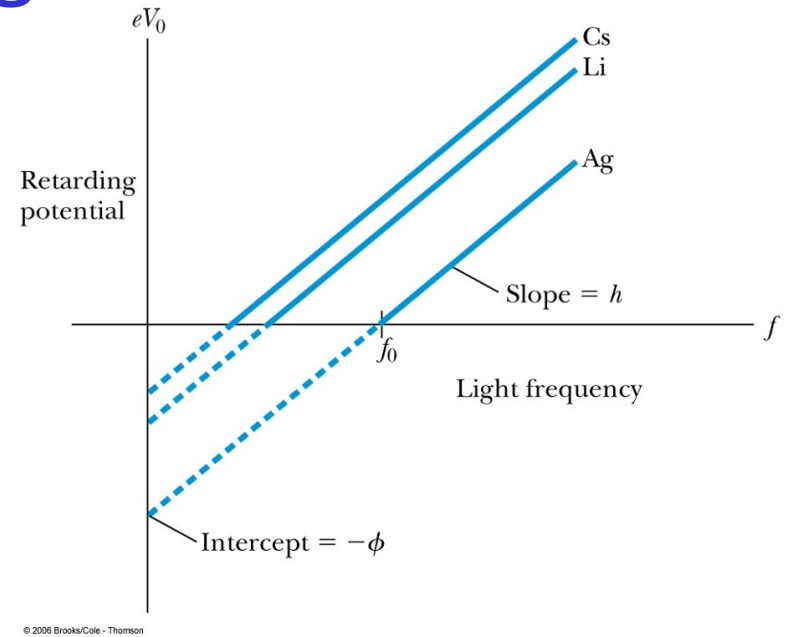
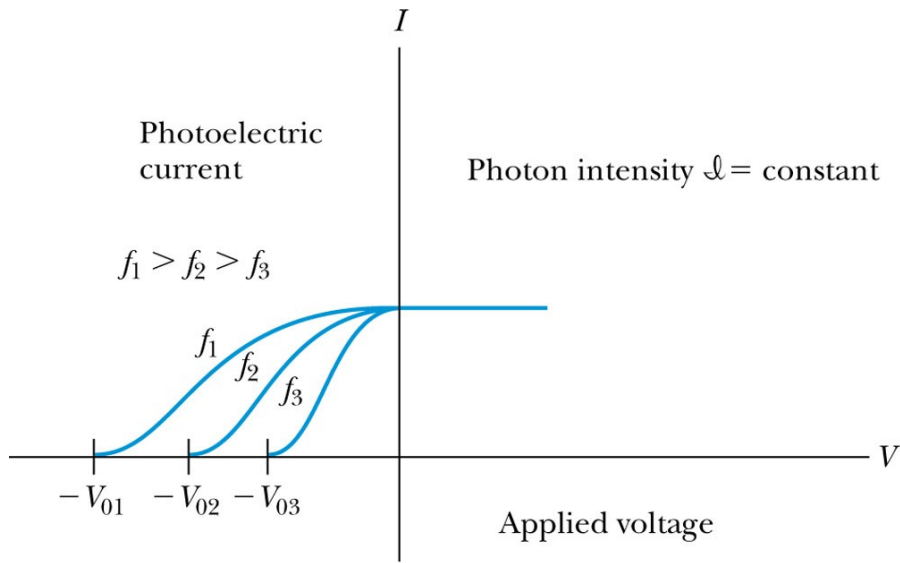

© 2006 Brooks/Cole - Thomson

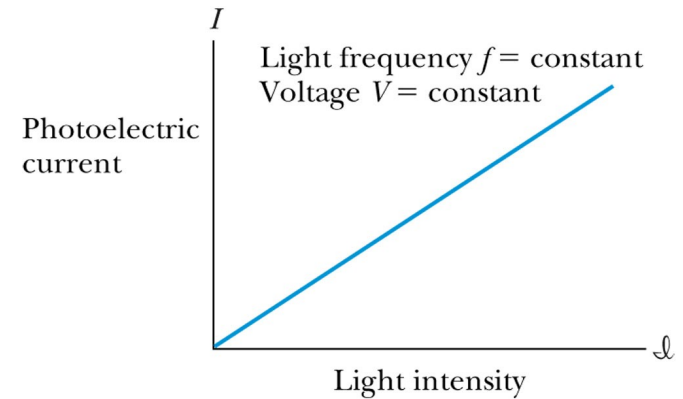

© 2006 Brooks/Cole - Thomson

Classical Interpretation

- Classical theory predicts that the total amount of energy in a light wave increases as the light intensity increases.
- The maximum kinetic energy of the photoelectrons depends on the value of the light frequency f and not on the intensity.
- The existence of a threshold frequency is completely inexplicable in classical theory.
- Classical theory would predict that for extremely low light intensities, a long time would elapse before any one electron could obtain sufficient energy to escape. We observe, however, that the photoelectrons are ejected almost immediately.

Einstein's Theory

- Einstein suggested that the electromagnetic radiation field is quantized into particles called **photons**. Each photon has the energy quantum:

$$E = hf$$

where f is the frequency of the light and h is Planck's constant.

- The photon travels at the speed of light in a vacuum, and its wavelength is given by

$$\lambda f = c$$

Einstein's Theory

- Conservation of energy yields:

Energy before (photon) = energy after (electron)

$$hf = \phi + \text{K.E. (electron)}$$

where ϕ is the work function of the metal.

Explicitly the energy is

$$hf = \phi + \frac{1}{2}mv_{\max}^2$$

- The retarding potentials measured in the photoelectric effect are the opposing potentials needed to stop the most energetic electrons.

$$eV_0 = \frac{1}{2}mv_{\max}^2$$

Quantum Interpretation

- The kinetic energy of the electron does not depend on the light intensity at all, but only on the light frequency and the work function of the material.

$$\frac{1}{2}mv_{\max}^2 = eV_0 = hf - \phi$$

- Einstein in 1905 predicted that the stopping potential was linearly proportional to the light frequency, with a slope h , the same constant found by Planck.

$$eV_0 = \frac{1}{2}mv_{\max}^2 = hf - hf_0 = h(f - f_0)$$

- From this, Einstein concluded that light is a particle with energy:

$$E = hf = \frac{hc}{\lambda}$$

3.7: X-Ray Production

- An energetic electron passing through matter will radiate photons and lose kinetic energy which is called **bremstrahlung**, from the German word for “braking radiation.” Since linear momentum must be conserved, the nucleus absorbs very little energy, and it is ignored. The final energy of the electron is determined from the conservation of energy to be

$$E_f = E_i - hf$$

- An electron that loses a large amount of energy will produce an X-ray photon. Current passing through a filament produces copious numbers of electrons by thermionic emission. These electrons are focused by the cathode structure into a beam and are accelerated by potential differences of thousands of volts until they impinge on a metal anode surface, producing x rays by bremstrahlung as they stop in the anode material.

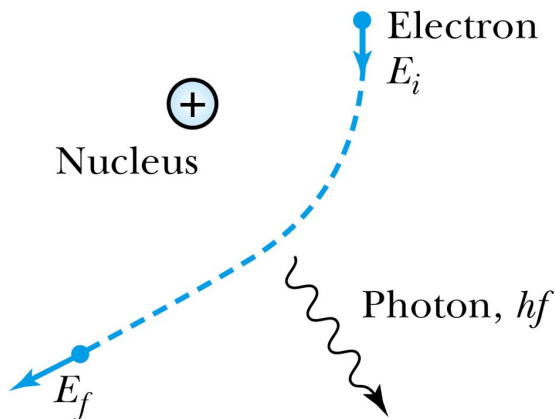

© 2006 Brooks/Cole - Thomson

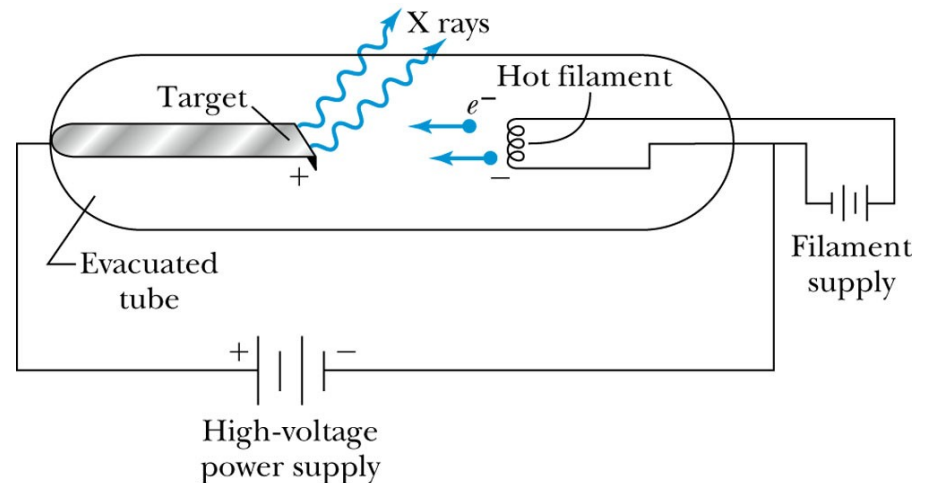

© 2006 Brooks/Cole - Thomson

Inverse Photoelectric Effect.

- Conservation of energy requires that the electron kinetic energy equal the maximum photon energy where we neglect the work function because it is normally so small compared to the potential energy of the electron. This yields the **Duane-Hunt limit** which was first found experimentally. The photon wavelength depends only on the accelerating voltage and is the same for all targets.

$$eV_0 = hf_{\max} = \frac{hc}{\lambda_{\min}}$$

$$\lambda_{\min} = \frac{hc}{eV_0} = \frac{1.240 \times 10^{-6} \text{ V} \cdot \text{m}}{V_0}$$

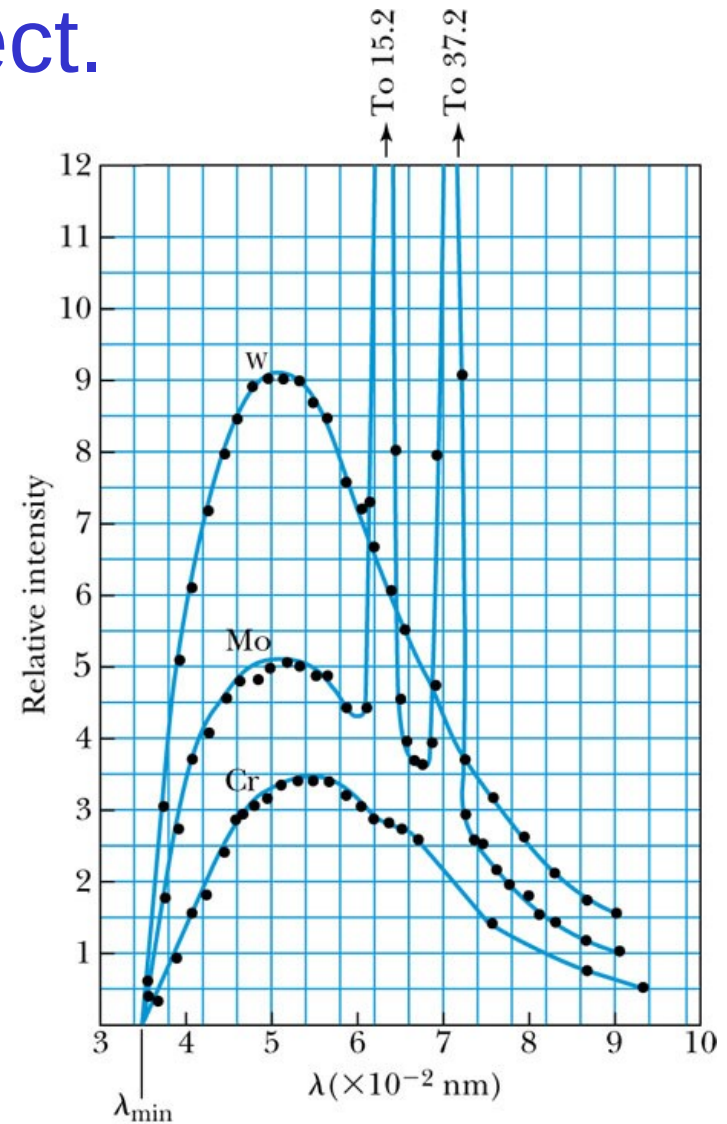

© 2006 Brooks/Cole - Thomson

3.8: Compton Effect

- When a photon enters matter, it is likely to interact with one of the atomic electrons. The photon is scattered from only one electron, rather than from all the electrons in the material, and the laws of conservation of energy and momentum apply as in any elastic collision between two particles. The momentum of a particle moving at the speed of light is

$$p = \frac{E}{c} = \frac{hf}{c} = \frac{h}{\lambda}$$

- The electron energy can be written as

$$E_e^2 = (mc^2)^2 + p_e^2 c^2$$

- This yields the change in wavelength of the scattered photon which is known as the **Compton effect**:

$$\Delta\lambda = \lambda' - \lambda = \frac{h}{mc} (1 - \cos\theta)$$

3.9: Pair Production and Annihilation

- If a photon can create an electron, it must also create a positive charge to balance charge conservation.
- In 1932, C. D. Anderson observed a positively charged electron (e^+) in cosmic radiation. This particle, called a positron, had been predicted to exist several years earlier by P. A. M. Dirac.
- A photon's energy can be converted entirely into an electron and a positron in a process called pair production.

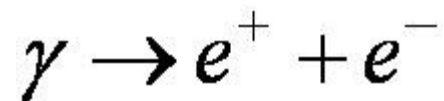

Pair Production in Empty Space

- Conservation of energy for pair production in empty space is

$$hf = E_+ + E_-$$

- Considering momentum conservation yields

$$hf = p_- c \cos \theta_- + p_+ c \cos \theta_+$$

- This energy exchange has the maximum value $hf_{\max} = p_- c + p_+ c$

- Recall that the total energy for a particle can be written as

$$E_{\pm}^2 = p_{\pm}^2 c^2 + m^2 c^4$$

However this yields a contradiction: $hf > p_- c + p_+ c$

and hence the conversion of energy in empty space is an impossible situation.

Pair Production in Matter

- Since the relations $hf_{\max} = p_-c + p_+c$
 $hf > p_-c + p_+c$
 contradict each other, a photon
 can not produce an electron and
 a positron in empty space.

- In the presence of matter, the
 nucleus absorbs some energy
 and momentum.

$$hf = E_+ + E_- + \text{K.E. (nucleus)}$$

- The photon energy required for
 pair production in the presence of
 matter is $hf > 2m_e c^2 = 1.022 \text{ MeV}$

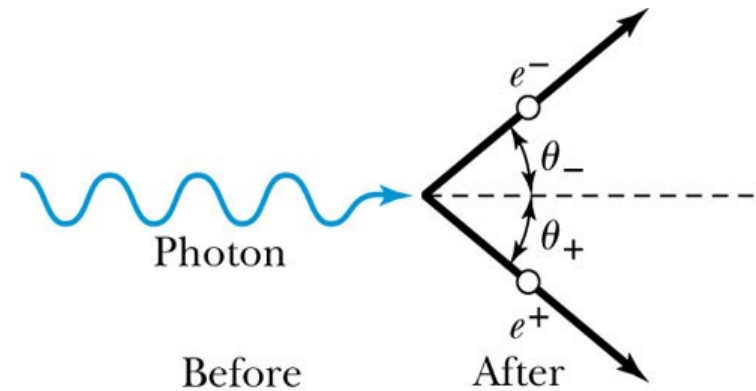

(a) Free space (**cannot occur**)

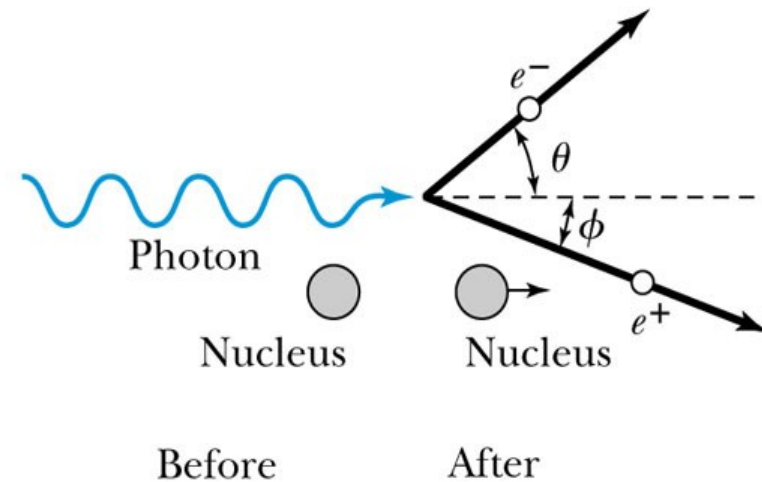

(b) Beside nucleus

© 2006 Brooks/Cole - Thomson

Pair Annihilation

- A positron passing through matter will likely **annihilate** with an electron. A positron is drawn to an electron by their mutual electric attraction, and the electron and positron then form an atomlike configuration called **positronium**.
- Pair annihilation in empty space will produce two photons to conserve momentum. Annihilation near a nucleus can result in a single photon.

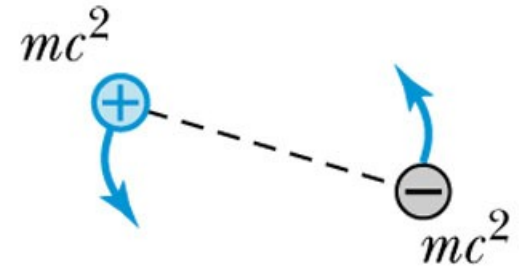

(a) Positronium, before decay (schematic only)

- Conservation of energy: $2m_e c^2 \approx hf_1 + hf_2$
- Conservation of momentum: $0 = \frac{hf_1}{c} - \frac{hf_2}{c}$
- The two photons will be almost identical, so that

$$f_1 = f_2 = f$$

- The two photons from positronium annihilation will move in opposite directions with an energy:

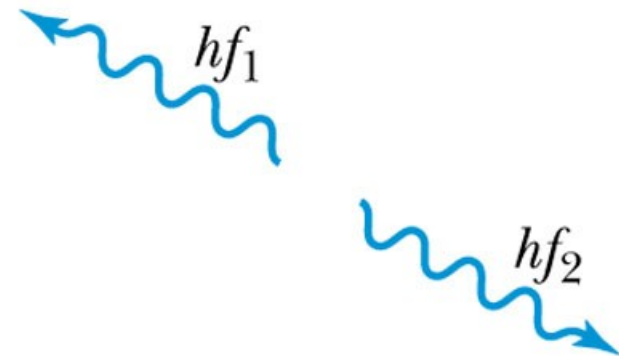

(b) After annihilation

© 2006 Brooks/Cole - Thomson

$$hf = m_e c^2 = 0.511 \text{ MeV}$$