

PowerPoint to accompany

**Introduction to MATLAB  
for Engineers, Third Edition**

**Chapter 5  
Advanced Plotting**



# Nomenclature for a typical xy plot. Figure 5.1–1, page 220

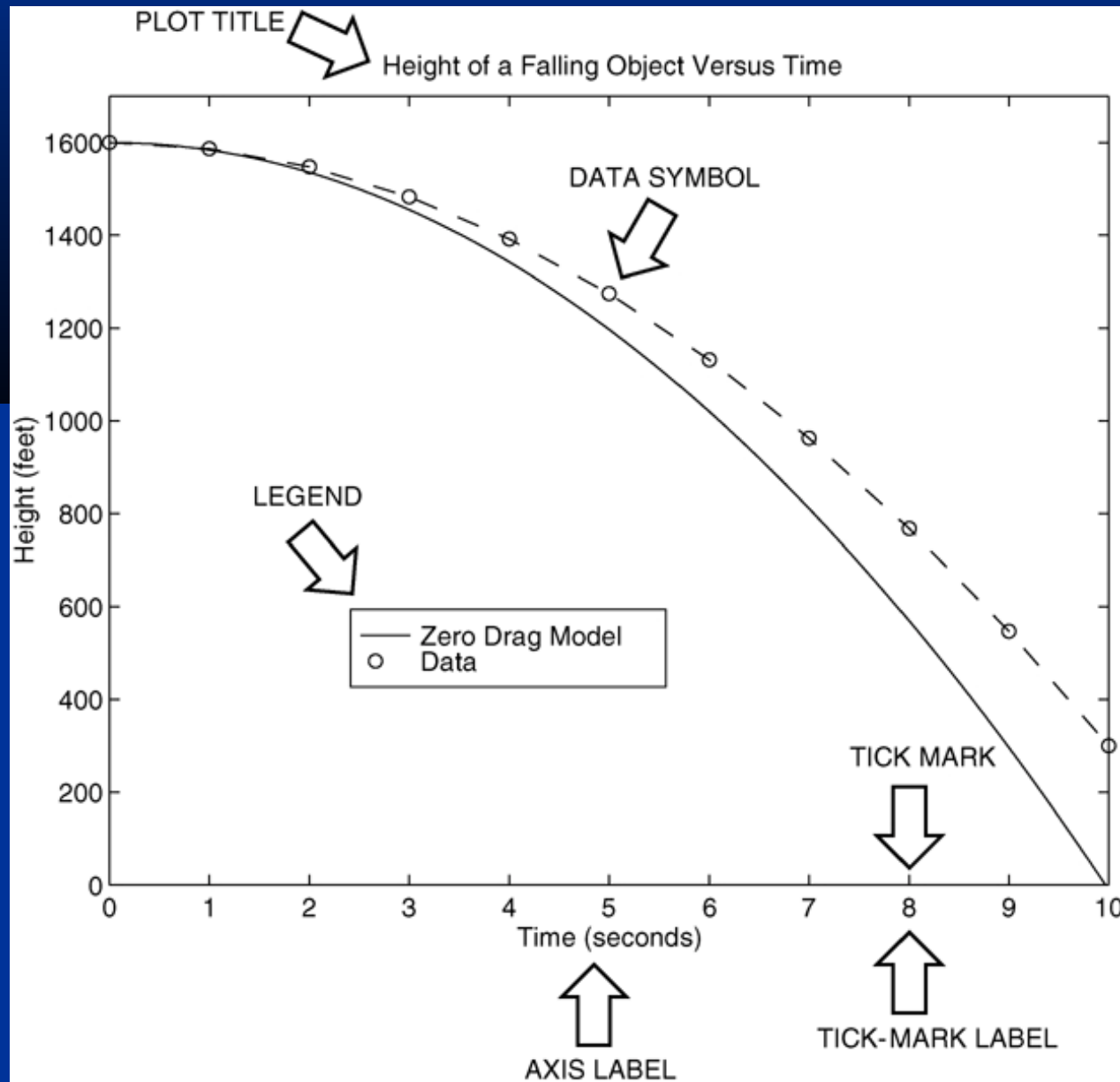

**An Example:** The following MATLAB session plots  $y = 0.4 \sqrt{1.8x}$  for  $0 \leq x \leq 52$ , where  $y$  represents the height of a rocket after launch, in miles, and  $x$  is the horizontal (downrange) distance in miles.

```
>>x = 0:0.1:52;  
>>y = 0.4*sqrt(1.8*x);  
>>plot(x,y)  
>>xlabel('Distance (miles)')  
>>ylabel('Height (miles)')  
>>title('Rocket Height as a Function of  
Downrange Distance')
```

The resulting plot is shown on the next slide.

# The autoscaling feature in MATLAB selects tick-mark spacing.

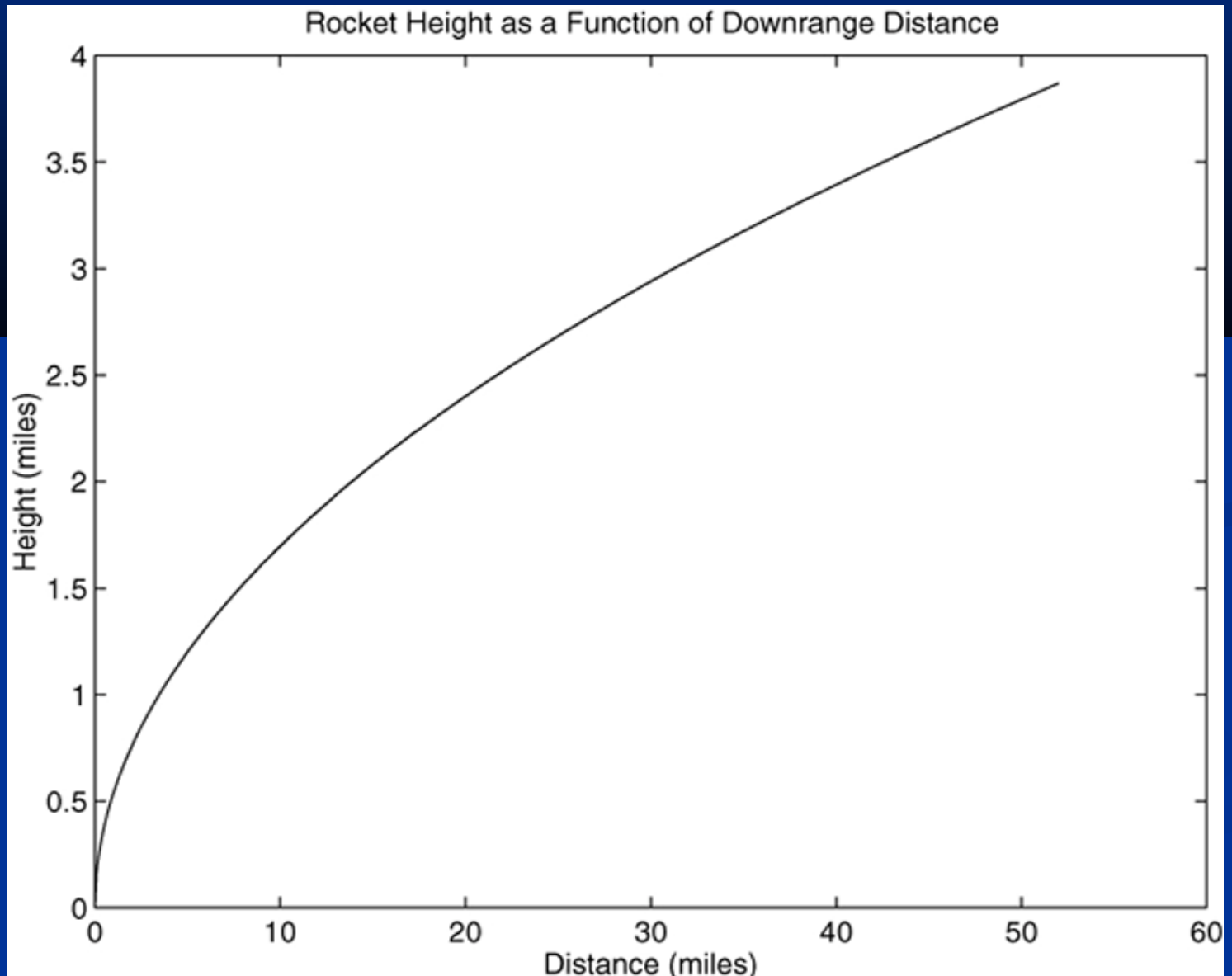

The plot will appear in the Figure window. You can obtain a hard copy of the plot in several ways:

1. Use the menu system. Select **Print** on the **File** menu in the Figure window. Answer **OK** when you are prompted to continue the printing process.
2. Type `print` at the command line. This command sends the current plot directly to the printer.
3. Save the plot to a file to be printed later or imported into another application such as a word processor. You need to know something about graphics file formats to use this file properly. See the subsection **Exporting Figures** (page 225).

When you have finished with the plot, close the figure window by selecting **Close** from the **File** menu in the figure window.

Note that using the **Alt-Tab** key combination in Windows-based systems will return you to the Command window without closing the figure window.

If you do not close the window, it will not reappear when a new `plot` command is executed. However, the figure will still be updated.

## Requirements for a Correct Plot (Table 5.1-1, page 221)

The following list describes the essential features of any plot:

1. Each axis must be labeled with the name of the quantity being plotted *and its units!* If two or more quantities having different units are plotted (such as when plotting both speed and distance versus time), indicate the units in the axis label if there is room, or in the legend or labels for each curve.
2. Each axis should have regularly spaced tick marks at convenient intervals—not too sparse, but not too dense—with a spacing that is easy to interpret and interpolate. For example, use 0.1, 0.2, and so on, rather than 0.13, 0.26, and so on.

(continued ...)

## Requirements for a Correct Plot (continued)

3. If you are plotting more than one curve or data set, label each on its plot or use a legend to distinguish them.
4. If you are preparing multiple plots of a similar type or if the axes' labels cannot convey enough information, use a title.
5. If you are plotting measured data, plot each data point with a symbol such as a circle, square, or cross (use the same symbol for every point in the same data set). If there are many data points, plot them using the dot symbol.

(continued ...)



## Requirements for a Correct Plot (continued)

6. Sometimes data symbols are connected by lines to help the viewer visualize the data, especially if there are few data points. However, connecting the data points, especially with a solid line, might be interpreted to imply knowledge of what occurs between the data points. Thus you should be careful to prevent such misinterpretation.
7. If you are plotting points generated by evaluating a function (as opposed to measured data), do *not* use a symbol to plot the points. Instead, be sure to generate many points, and connect the points with solid lines.

## The `grid` and `axis` Commands

The `grid` command displays gridlines at the tick marks corresponding to the tick labels. Type `grid on` to add gridlines; type `grid off` to stop plotting gridlines. When used by itself, `grid` toggles this feature on or off, but you might want to use `grid on` and `grid off` to be sure.

You can use the `axis` command to override the MATLAB selections for the axis limits. The basic syntax is `axis([xmin xmax ymin ymax])`. This command sets the scaling for the  $x$ - and  $y$ -axes to the minimum and maximum values indicated. Note that, unlike an array, this command does not use commas to separate the values.

More? See page 222.

# Example of a Figure window. Figure 5.1–2

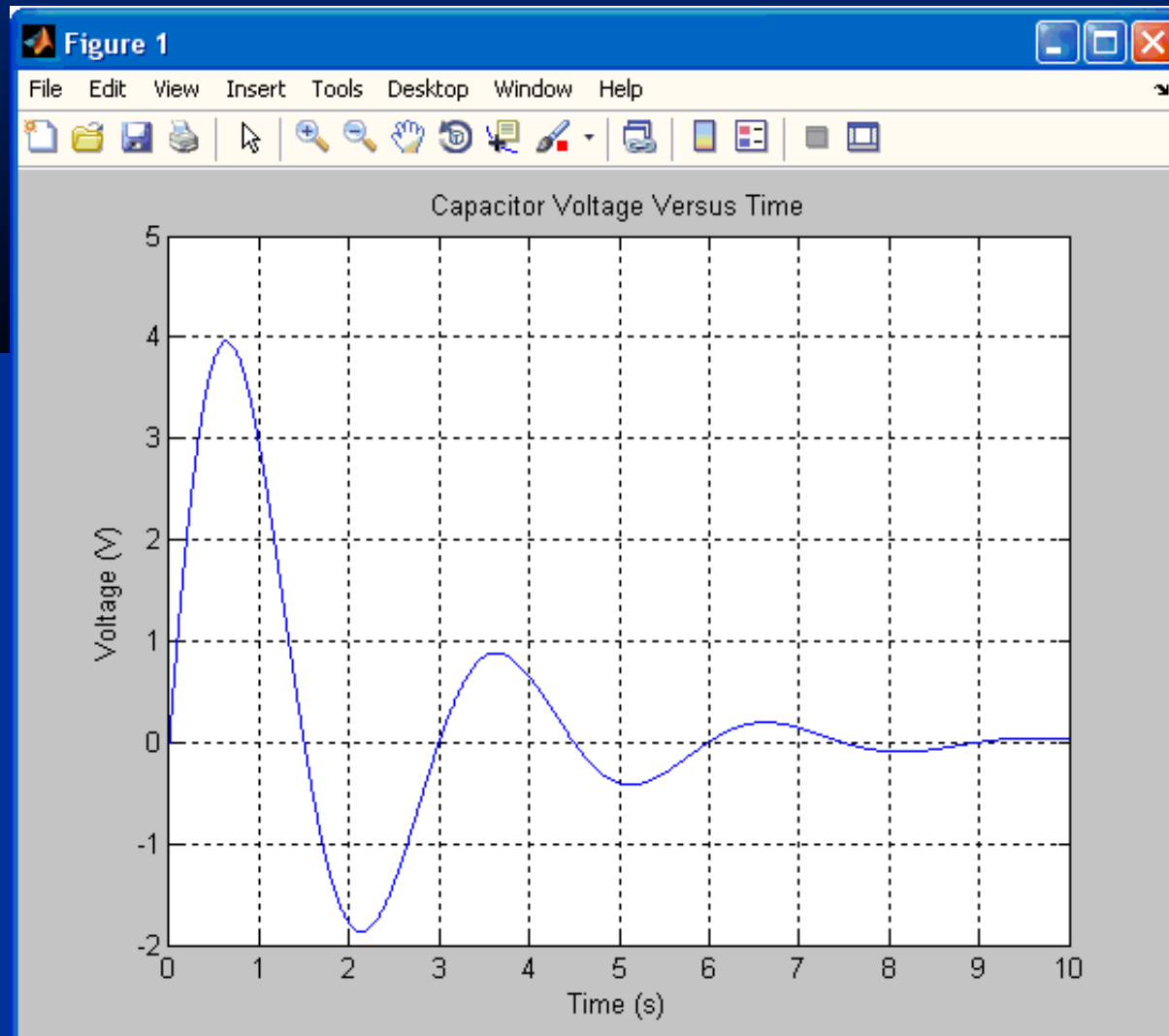

The `fp1ot` command is a “smart” plotting function. Figure 5.1–3a  
See pages 223-224.

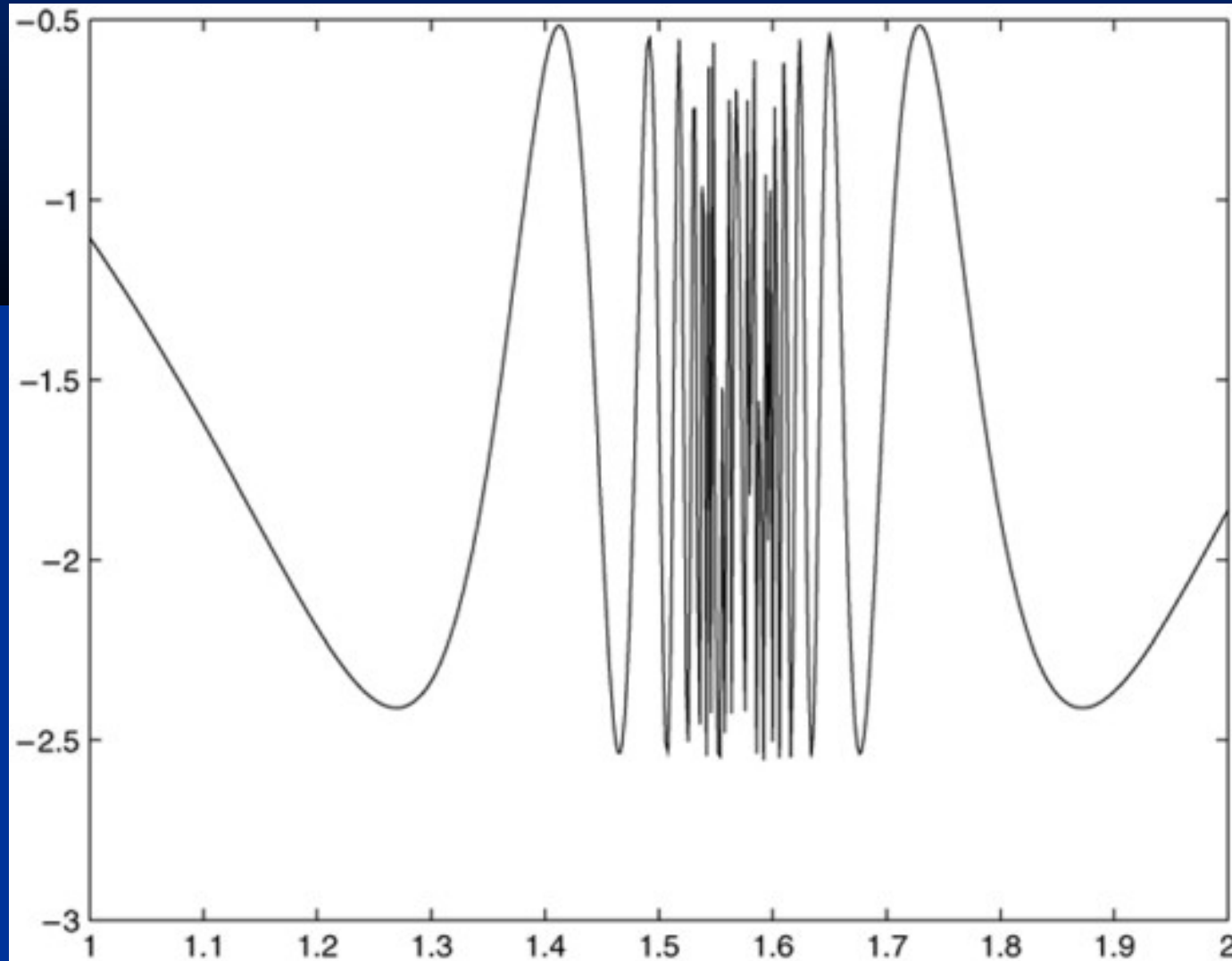

The function in Figure 5.1–3b generated with the `plot` command, which gives more control than the `fplot` command.

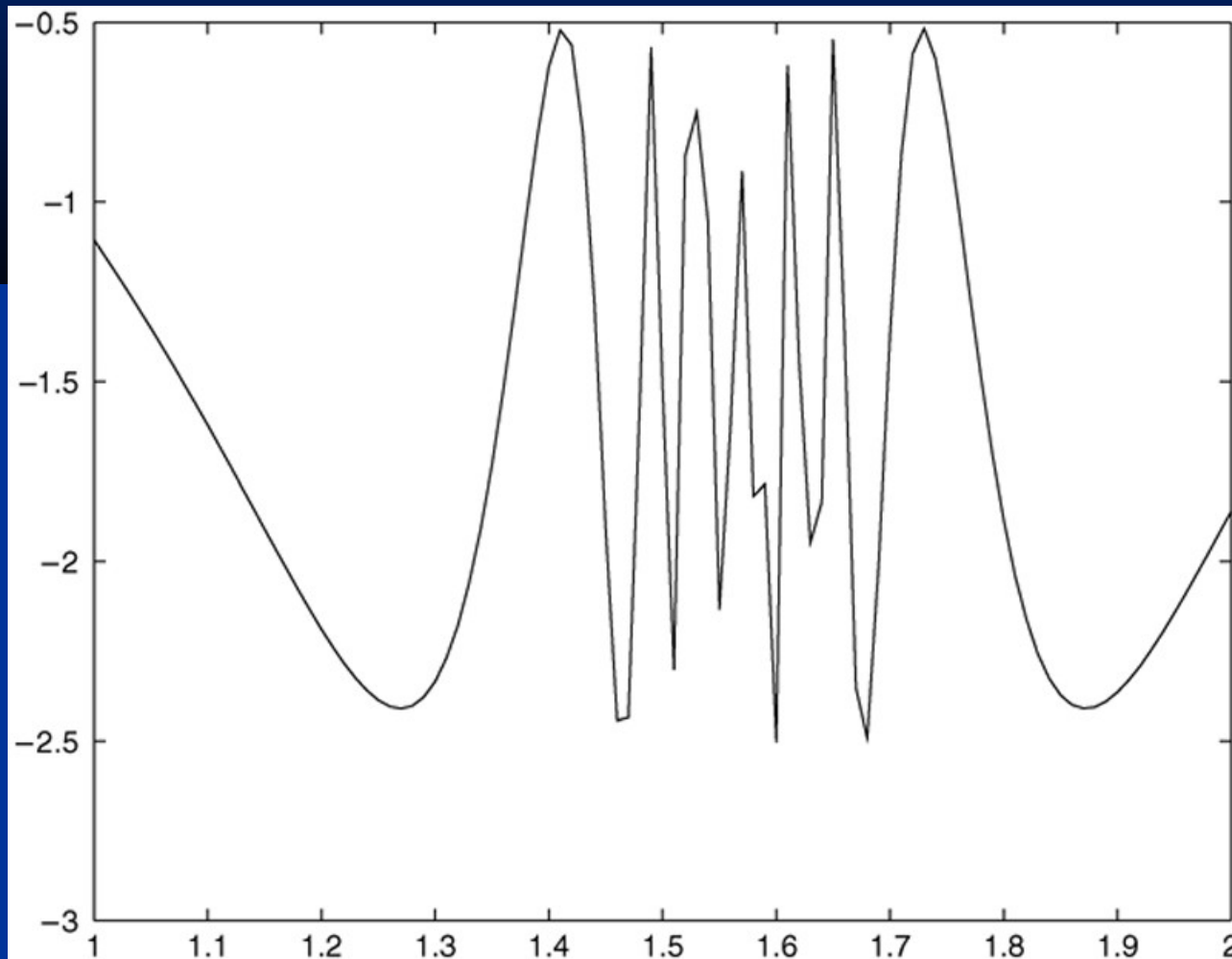

## Plotting Polynomials with the `polyval` Function.

To plot the polynomial  $3x^5 + 2x^4 - 100x^3 + 2x^2 - 7x + 90$  over the range  $-6 \leq x \leq 6$  with a spacing of 0.01, you type

```
>>x = -6:0.01:6;  
>>p = [3,2,-100,2,-7,90];  
>>plot(x,polyval(p,x),xlabel('x'), ...  
        ylabel('p'))
```

## Saving Figures

To save a figure that can be opened in subsequent MATLAB sessions, save it in a figure file with the .fig file name extension.

To do this, select **Save** from the Figure window **File** menu or click the **Save** button (the disk icon) on the toolbar.

If this is the first time you are saving the file, the **Save As** dialog box appears. Make sure that the type is MATLAB Figure (\*.fig). Specify the name you want assigned to the figure file. Click OK.

## Exporting Figures

To save the figure in a format that can be used by another application, such as the standard graphics file formats TIFF or EPS, perform these steps.

1. Select **Export Setup** from the **File** menu. This dialog lets you specify options for the output file, such as the figure size, fonts, line size and style, and output format.
2. Select **Export** from the **Export Setup** dialog. A standard **Save As** dialog appears.
3. Select the format from the list of formats in the **Save As** type menu. This selects the format of the exported file and adds the standard file name extension given to files of that type.
4. Enter the name you want to give the file, less the extension. Then click **Save**.



On Windows systems, you can also copy a figure to the clipboard and then paste it into another application:

1. Select **Copy Options** from the **Edit** menu. The **Copying Options** page of the **Preferences** dialog box appears.
2. Complete the fields on the **Copying Options** page and click **OK**.
3. Select **Copy Figure** from the **Edit** menu.

## Hints for Improving Plots (Table 5.1-3, page 226)

The following actions, while not required, can nevertheless improve the appearance of your plots:

1. Start scales from zero whenever possible. This technique prevents a false impression of the magnitudes of any variations shown on the plot.
2. Use sensible tick-mark spacing. If the quantities are months, choose a spacing of 12 because 1/10 of a year is not a convenient division. Space tick marks as close as is useful, but no closer. If the data is given monthly over a range of 24 months, 48 tick marks might be too dense, and also unnecessary.

(continued ...)

## Hints for Improving Plots (continued)

3. Minimize the number of zeros in the data being plotted. For example, use a scale in millions of dollars when appropriate, instead of a scale in dollars with six zeros after every number.
4. Determine the minimum and maximum data values for each axis before plotting the data. Then set the axis limits to cover the entire data range plus an additional amount to allow convenient tick-mark spacing to be selected.

For example, if the data on the  $x$ -axis ranges from 1.2 to 9.6, a good choice for axis limits is 0 to 10. This choice allows you to use a tick spacing of 1 or 2.

(continued ...)

## Hints for Improving Plots (continued)

5. Use a different line type for each curve when several are plotted on a single plot and they cross each other; for example, use a solid line, a dashed line, and combinations of lines and symbols. Beware of using colors to distinguish plots if you are going to make black-and-white printouts and photocopies.
6. Do not put many curves on one plot, particularly if they will be close to each other or cross one another at several points.
7. Use the same scale limits and tick spacing on each plot if you need to compare information on more than one plot.

## Subplots

You can use the `subplot` command to obtain several smaller “subplots” in the same figure. The syntax is `subplot(m, n, p)`. This command divides the Figure window into an array of rectangular panes with  $m$  rows and  $n$  columns. The variable  $p$  tells MATLAB to place the output of the `plot` command following the `subplot` command into the  $p$ th pane.

For example, `subplot(3, 2, 5)` creates an array of six panes, three panes deep and two panes across, and directs the next plot to appear in the fifth pane (in the bottom-left corner).

The following script file created Figure 5.2–1, which shows the plots of the functions  $y = e^{-1.2x} \sin(10x + 5)$  for  $0 \leq x \leq 5$  and  $y = |x^3 - 100|$  for  $-6 \leq x \leq 6$ .

```
x = 0:0.01:5;  
y = exp(-1.2*x).*sin(10*x+5);  
subplot(1,2,1)  
plot(x,y),axis([0 5 -1 1])  
x = -6:0.01:6;  
y = abs(x.^3-100);  
subplot(1,2,2)  
plot(x,y),axis([-6 6 0 350])
```

The figure is shown  
on the next slide.

# Application of the subplot command. Figure 5.2–1

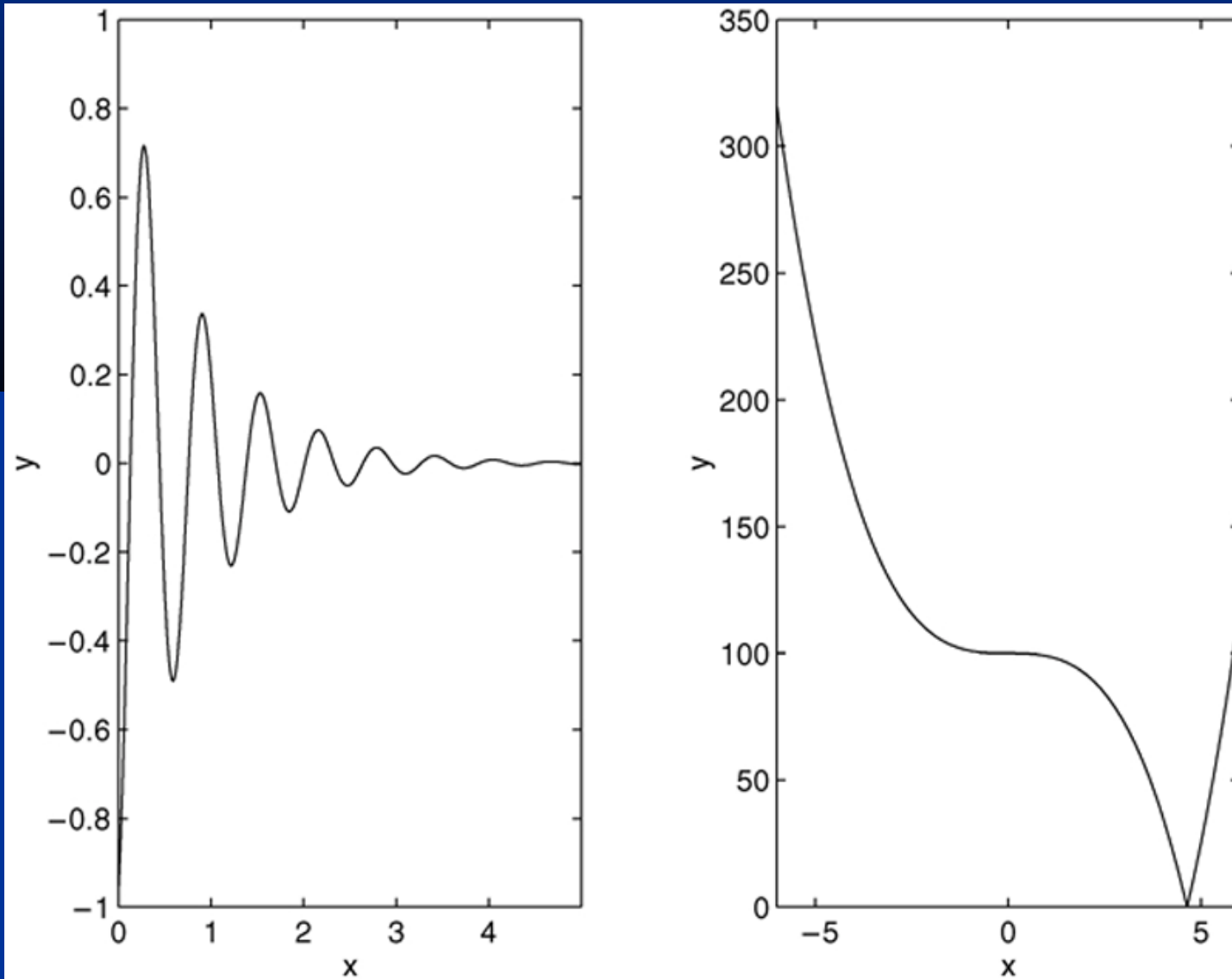

## Data Markers and Line Types

To plot  $y$  versus  $x$  with a solid line and  $u$  versus  $v$  with a dashed line, type `plot(x, y, u, v, '- -')`, where the symbols `' - - '` represent a dashed line.

Table 5.2–1 gives the symbols for other line types.

To plot  $y$  versus  $x$  with asterisks (\*) connected with a dotted line, you must plot the data twice by typing `plot(x, y, '*:', x, y, ':')`.



To plot  $y$  versus  $x$  with green asterisks (\*) connected with a red dashed line, you must plot the data twice by typing `plot(x, y, 'g*', x, y, 'r--')`.

# Specifiers for data markers, line types, and colors.

Table 5.2–1, page 228.

Data markers <sup>†</sup>		Line types		Colors	
Dot (.)	.	Solid line	—	Black	k
Asterisk (*)	*	Dashed line	--	Blue	b
Cross (×)	×	Dash-dotted line	-.	Cyan	c
Circle (○)	o	Dotted line	....	Green	g
Plus sign (+)	+			Magenta	m
Square (□)	s			Red	r
Diamond (◇)	d			White	w
Five-pointed star (w)	p			Yellow	y

<sup>†</sup>Other data markers are available. Search for “markers” in MATLAB help.

# Use of data markers. Figure 5.2–2, page 229.

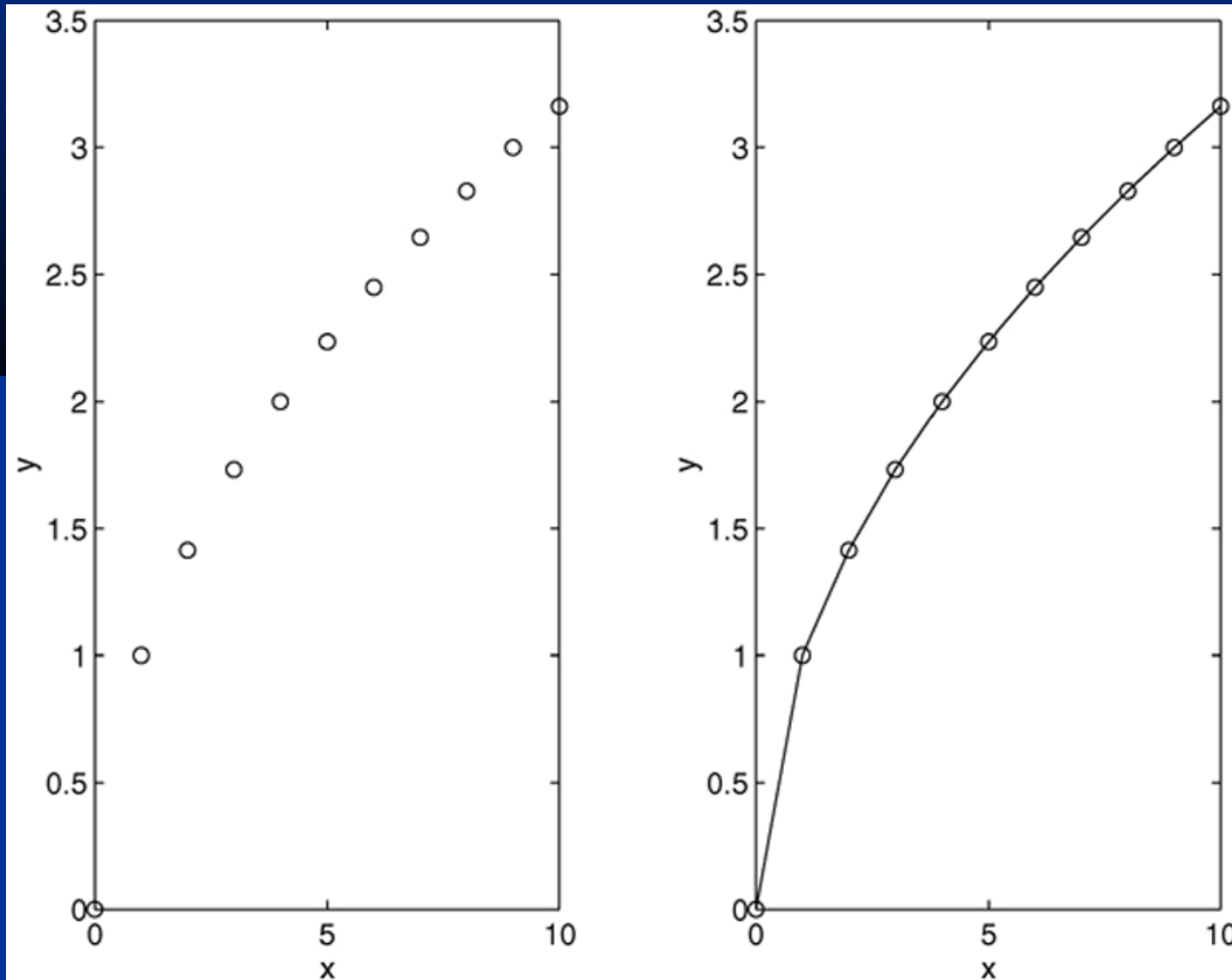

More?  
See  
pages  
273-274.

## Labeling Curves and Data

The `legend` command automatically obtains from the plot the line type used for each data set and displays a sample of this line type in the legend box next to the string you selected. The following script file produced the plot in Figure 5.2–3 (see next slide).

```
x = 0:0.01:2;  
y = sinh(x);  
z = tanh(x);  
plot(x,y,x,z,'--'),xlabel('x'), ...  
ylabel('Hyperbolic Sine and  
Tangent'), ...  
legend('sinh(x)', 'tanh(x)')
```

# Application of the `legend` command. Figure 5.2–3, page 230

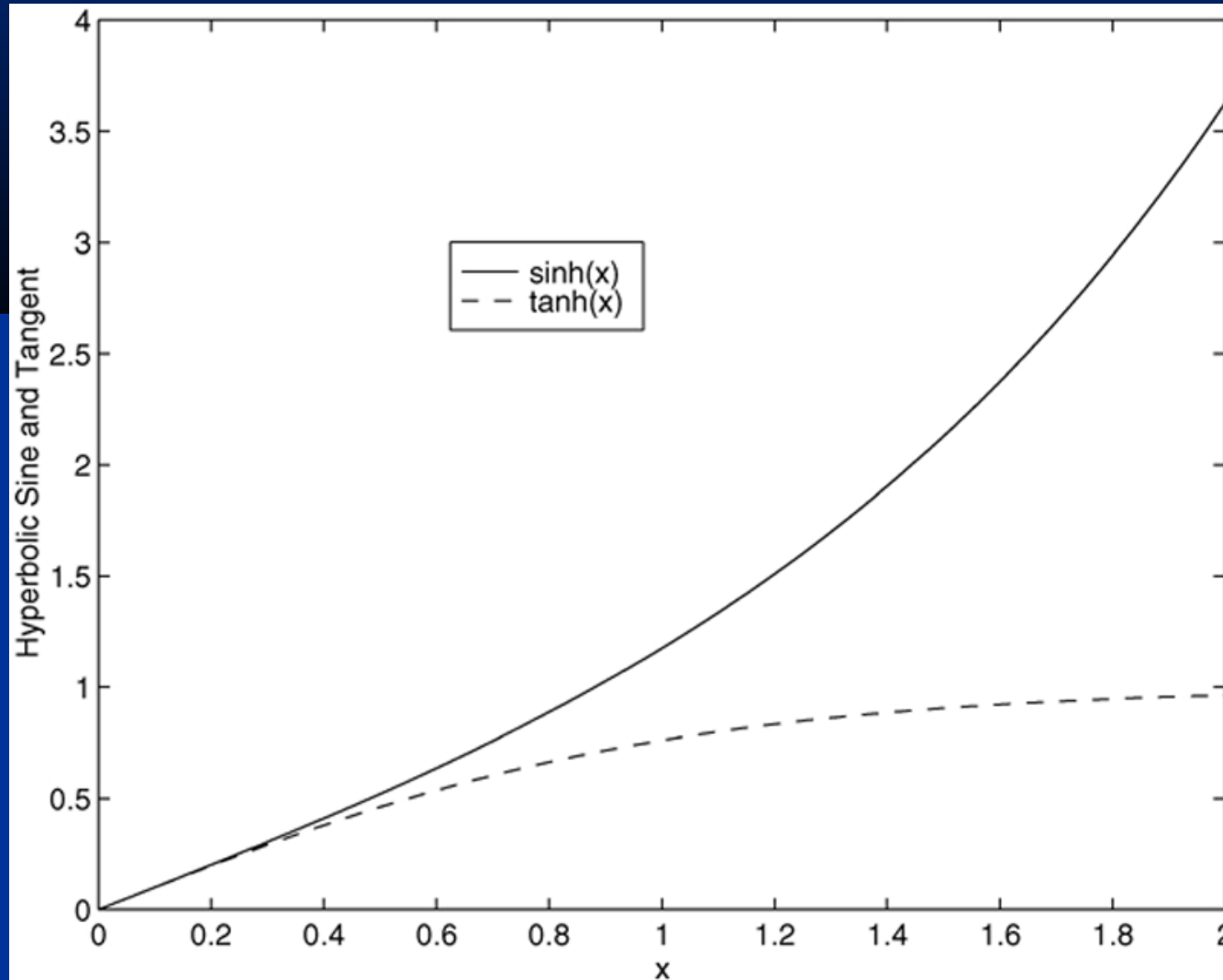

# Application of the hold command. Figure 5.2–4, page 231

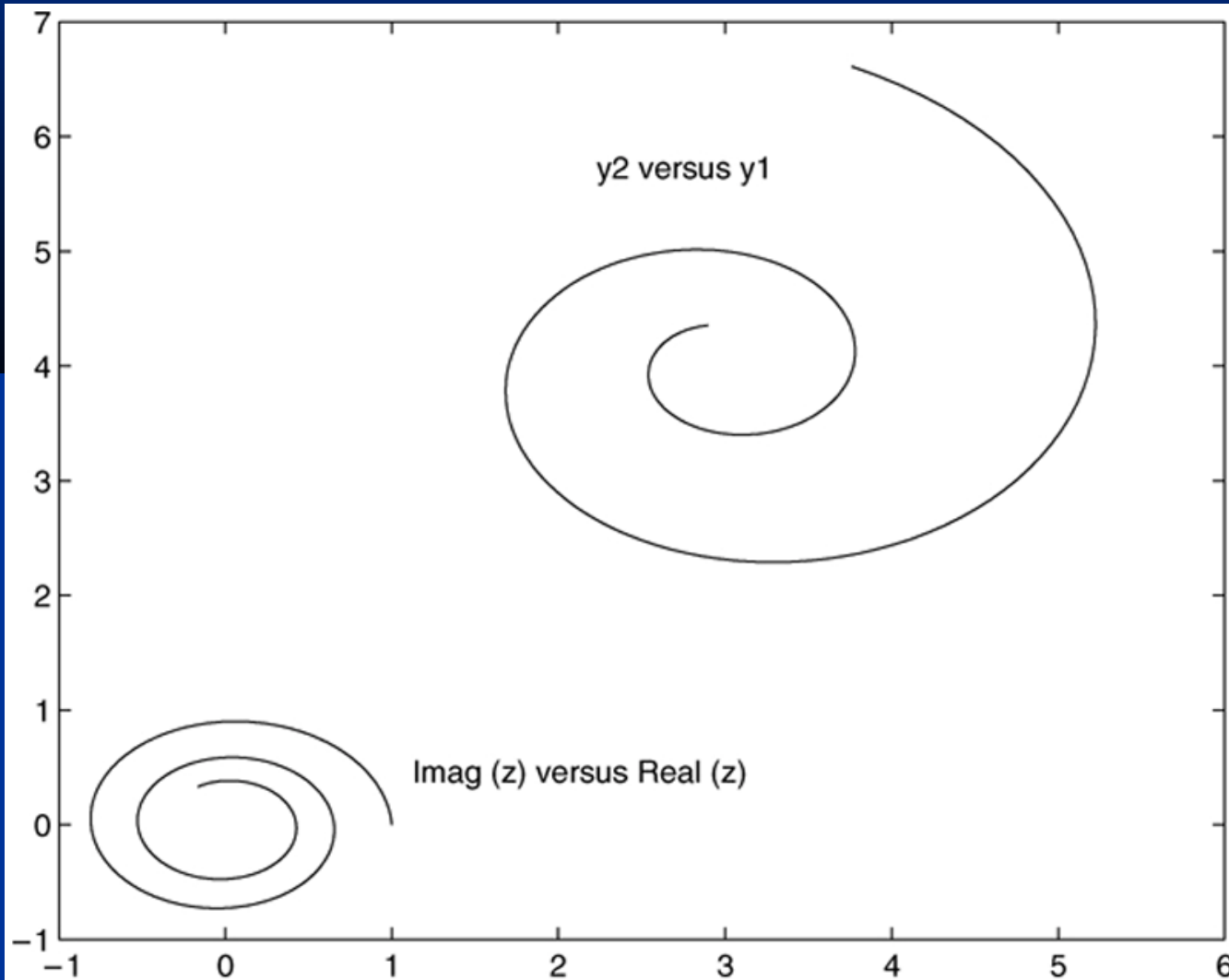

**Why use log scales? Rectilinear scales cannot properly display variations over wide ranges. Figure 5.2-5a, page 233.**

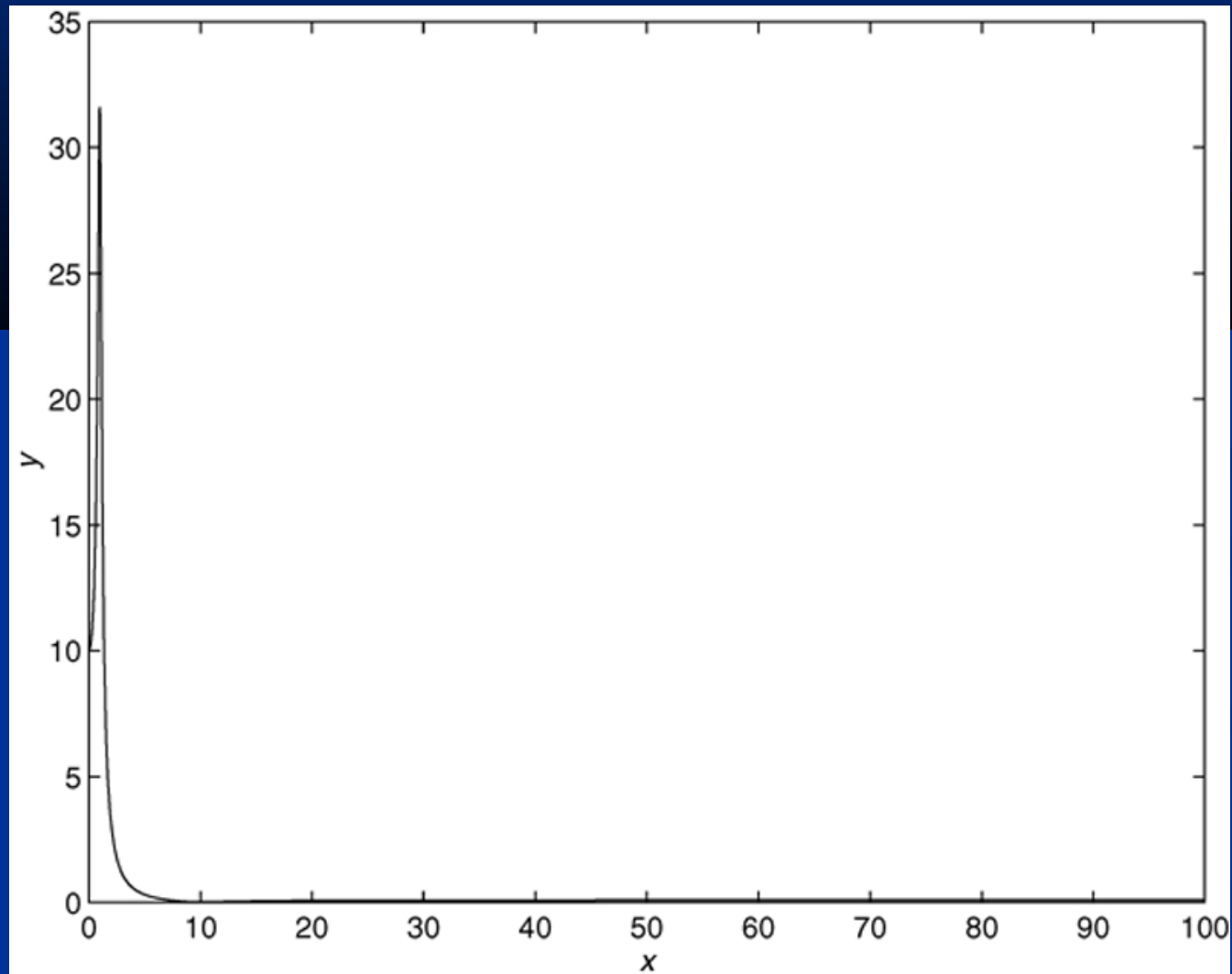

**A log-log plot can display wide variations in data values.**  
Figure 5.2-5b, page 233.

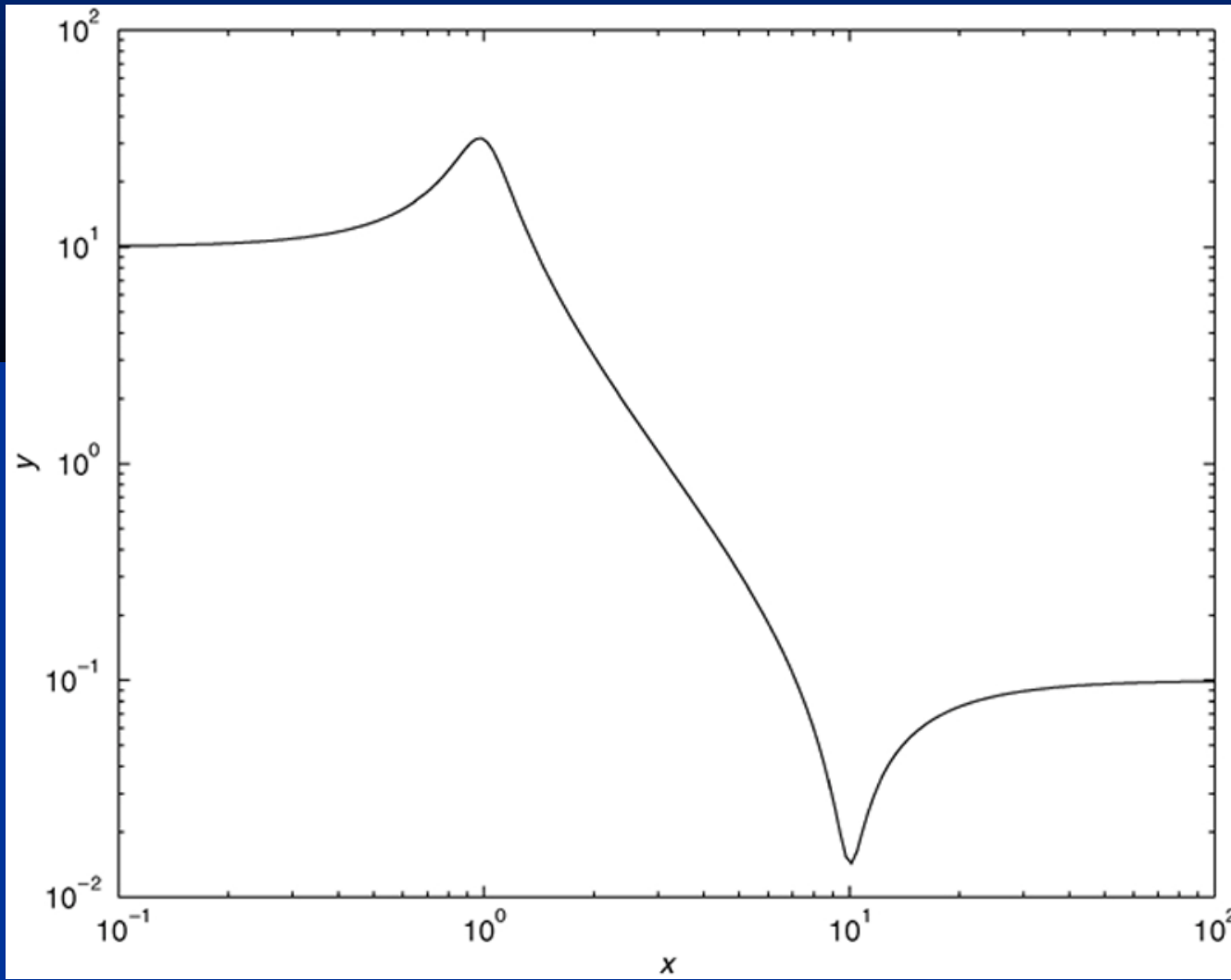

See  
pages  
233-  
234.



## Logarithmic Plots

It is important to remember the following points when using log scales:

1. You cannot plot negative numbers on a log scale, because the logarithm of a negative number is not defined as a real number.
2. You cannot plot the number 0 on a log scale, because  $\log_{10} 0 = \ln 0 = -\infty$ . You must choose an appropriately small number as the lower limit on the plot.

(continued...)

## Logarithmic Plots (continued)

3. The tick-mark labels on a log scale are the actual values being plotted; they are not the logarithms of the numbers. For example, the range of  $x$  values in the plot in Figure 5.3–2 is from  $10^{-1} = 0.1$  to  $10^2 = 100$ .
4. Gridlines and tick marks within a decade are unevenly spaced. If 8 gridlines or tick marks occur within the decade, they correspond to values equal to 2, 3, 4, . . . , 8, 9 times the value represented by the first gridline or tick mark of the decade.

(continued...)

## Logarithmic Plots (continued)

5. Equal distances on a log scale correspond to multiplication by the same constant (as opposed to addition of the same constant on a rectilinear scale).

For example, all numbers that differ by a factor of 10 are separated by the same distance on a log scale. That is, the distance between 0.3 and 3 is the same as the distance between 30 and 300. This separation is referred to as a *decade* or *cycle*.

The plot shown in Figure 5.3–2 covers three decades in  $x$  (from 0.1 to 100) and four decades in  $y$  and is thus called a *four-by-three-cycle plot*.

MATLAB has three commands for generating plots having log scales. The appropriate command depends on which axis must have a log scale.

1. Use the `loglog(x, y)` command to have both scales logarithmic.
2. Use the `semilogx(x, y)` command to have the  $x$  scale logarithmic and the  $y$  scale rectilinear.
3. Use the `semilogy(x, y)` command to have the  $y$  scale logarithmic and the  $x$  scale rectilinear.

## Specialized plot commands. Table 5.2-3, page 236

Command	Description
<code>bar(x,y)</code>	Creates a bar chart of y versus x.
<code>plotyy(x1,y1,x2,y2)</code>	Produces a plot with two y-axes, y1 on the left and y2 on the right.
<code>polar(theta,r,'type')</code>	Produces a polar plot from the polar coordinates theta and r, using the line type, data marker, and colors specified in the string type.
<code>stairs(x,y)</code>	Produces a stairs plot of y versus x.
<code>stem(x,y)</code>	Produces a stem plot of y versus x.

# Exponential and Power Functions Plotted on Log Scales (Figure 5.2-6, page 235)

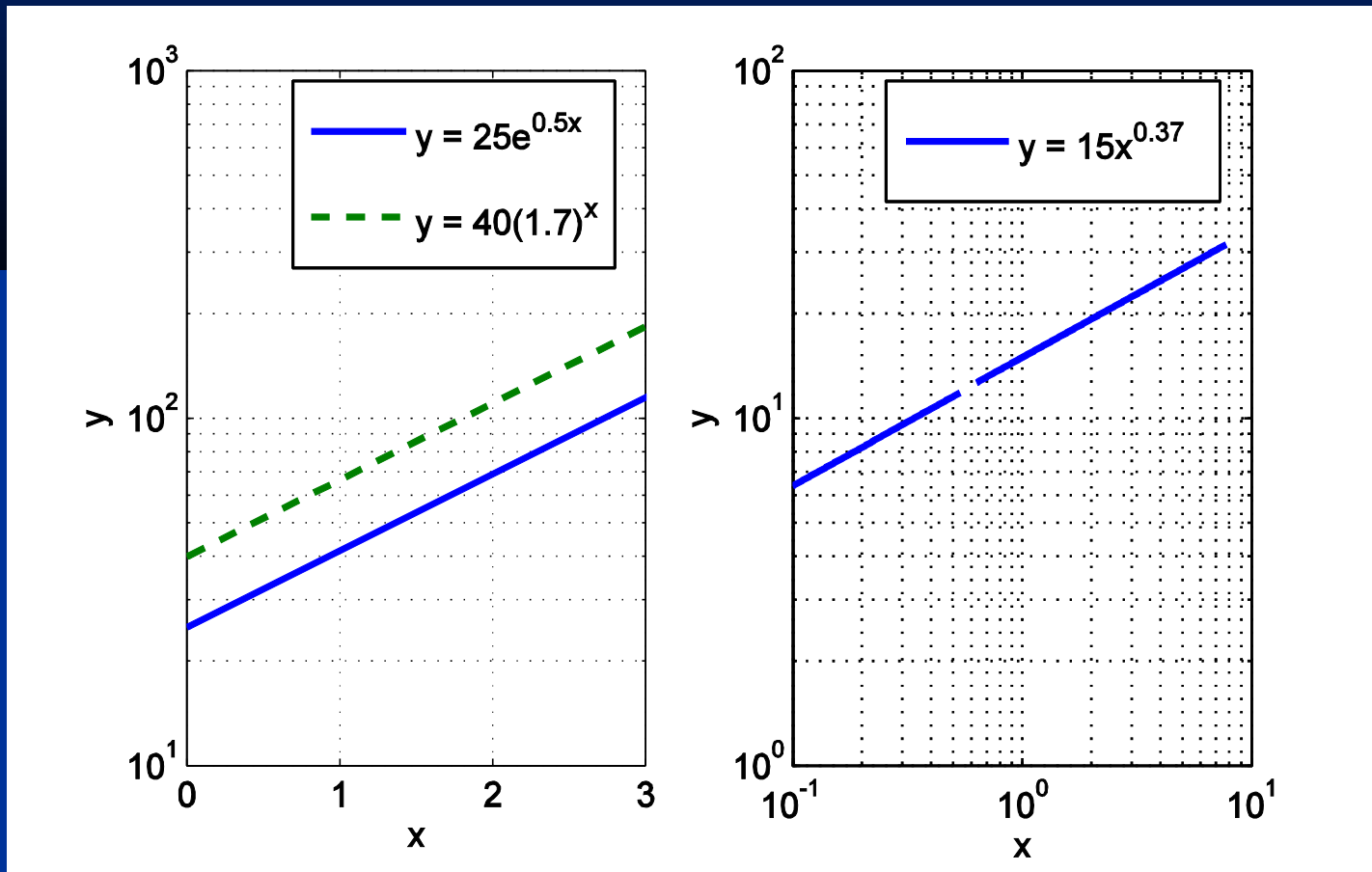

A polar plot showing an orbit having an eccentricity of 0.5.  
Figure 5.2–7, page 237.

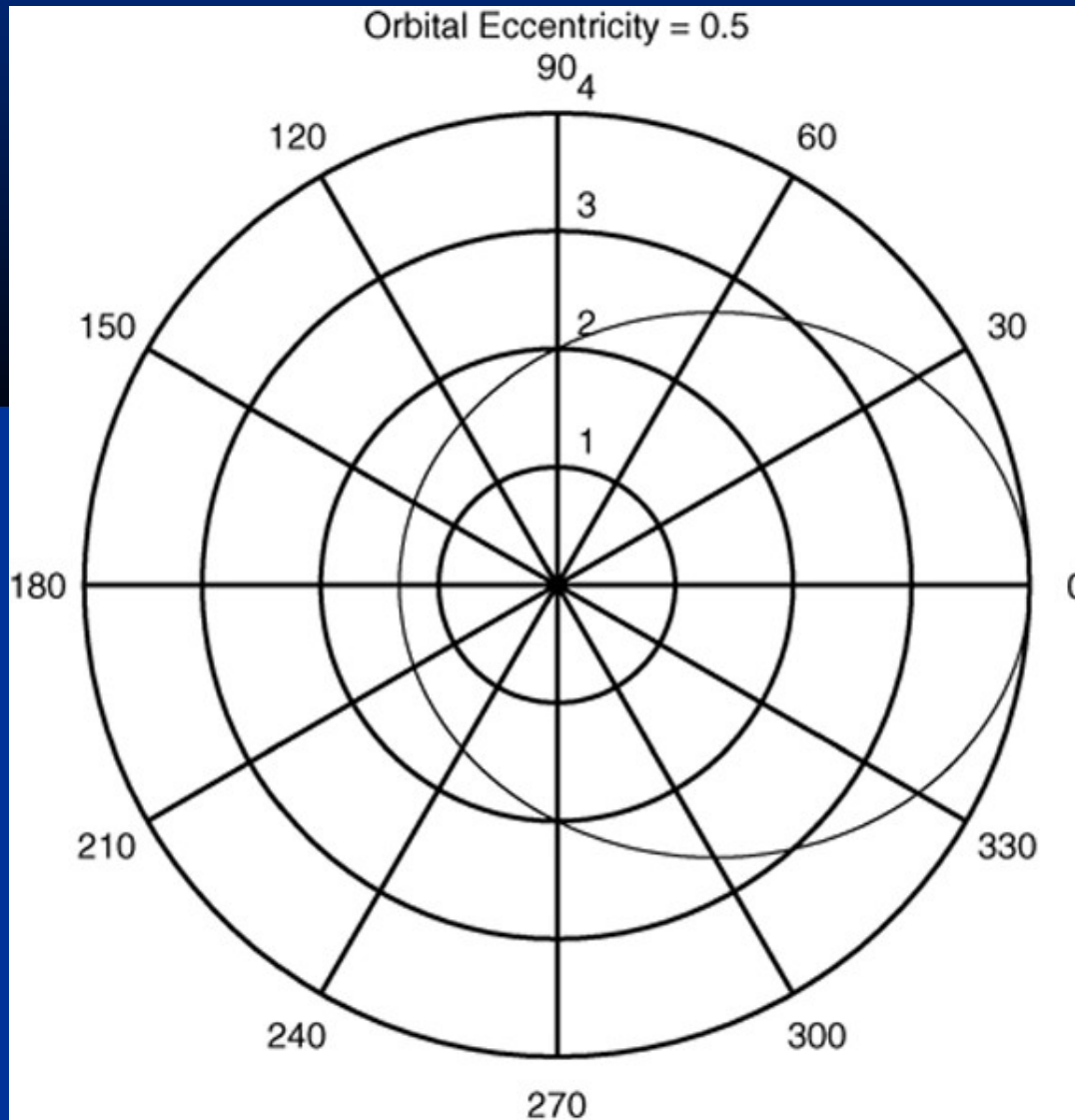

See pages  
236-237.

# Error Plots, Figure 5.2-8, page 238.

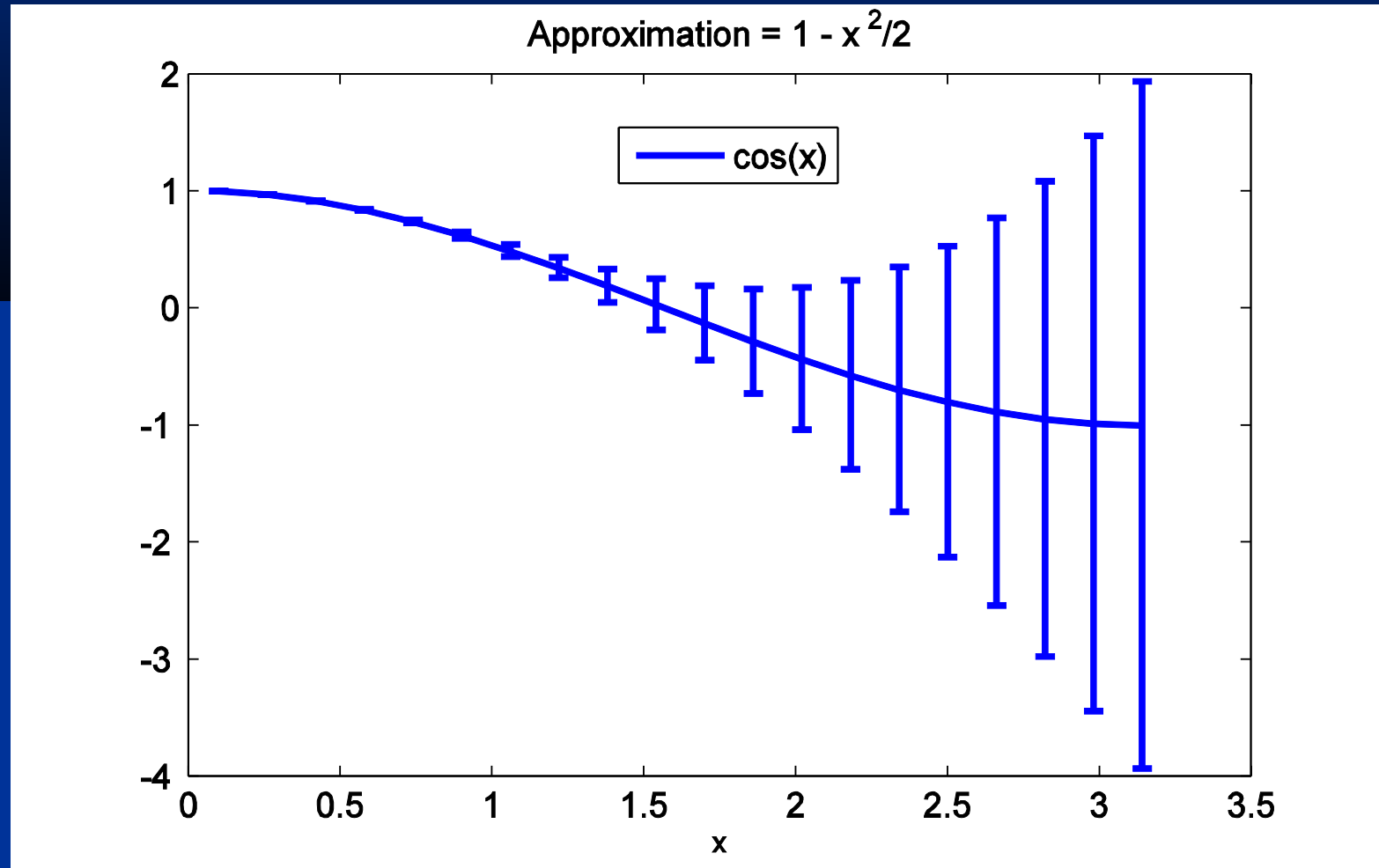



# **Publishing Reports Containing Graphics**

## **See Pages 238-240.**

# Interactive Plotting in MATLAB

This interface can be advantageous in situations where:

- You need to create a large number of different types of plots,
- You must construct plots involving many data sets,
- You want to add annotations such as rectangles and ellipses, or
- You want to change plot characteristics such as tick spacing, fonts, bolding, italics, and colors.

The interactive plotting environment in MATLAB is a set of tools for:

- Creating different types of graphs,
- Selecting variables to plot directly from the Workspace Browser,
- Creating and editing subplots,
- Adding annotations such as lines, arrows, text, rectangles, and ellipses, and
- Editing properties of graphics objects, such as their color, line weight, and font.

The Figure toolbar displayed. Figure 5.3–1, page 241.

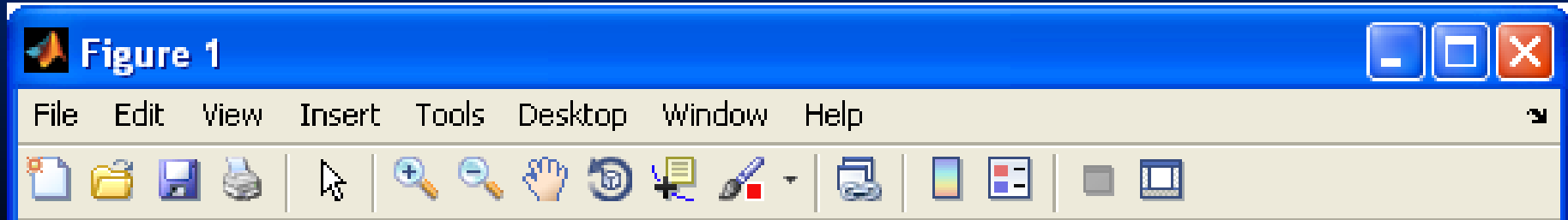

The Figure and Plot Edit toolbars displayed. Figure 5.3–2, page 243.

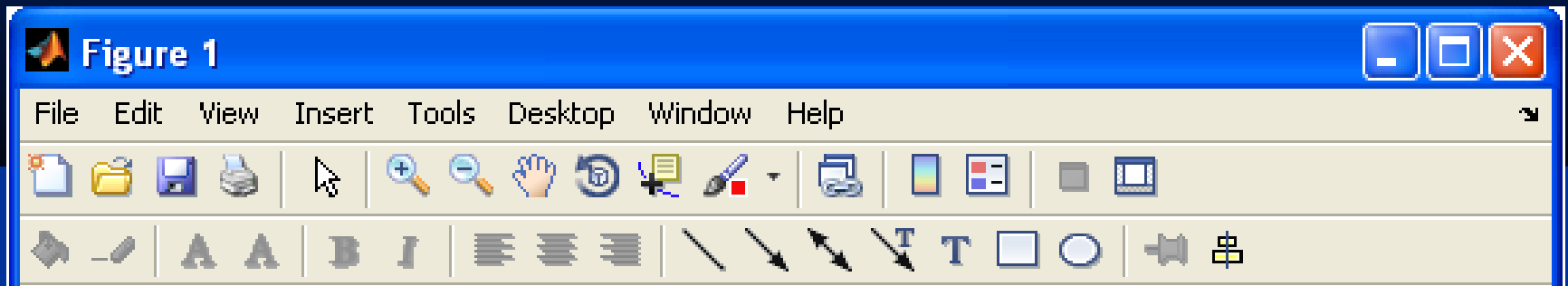

The Plot Tools interface includes the following three panels associated with a given figure.

- **The Figure Palette:** Use this to create and arrange subplots, to view and plot workspace variables, and to add annotations.
- **The Plot Browser:** Use this to select and control the visibility of the axes or graphics objects plotted in the figure, and to add data for plotting.
- **The Property Editor:** Use this to set basic properties of the selected object and to obtain access to all properties through the Property Inspector.

# The Figure window with the Plot Tools activated. Figure 5.3-3, page 244.

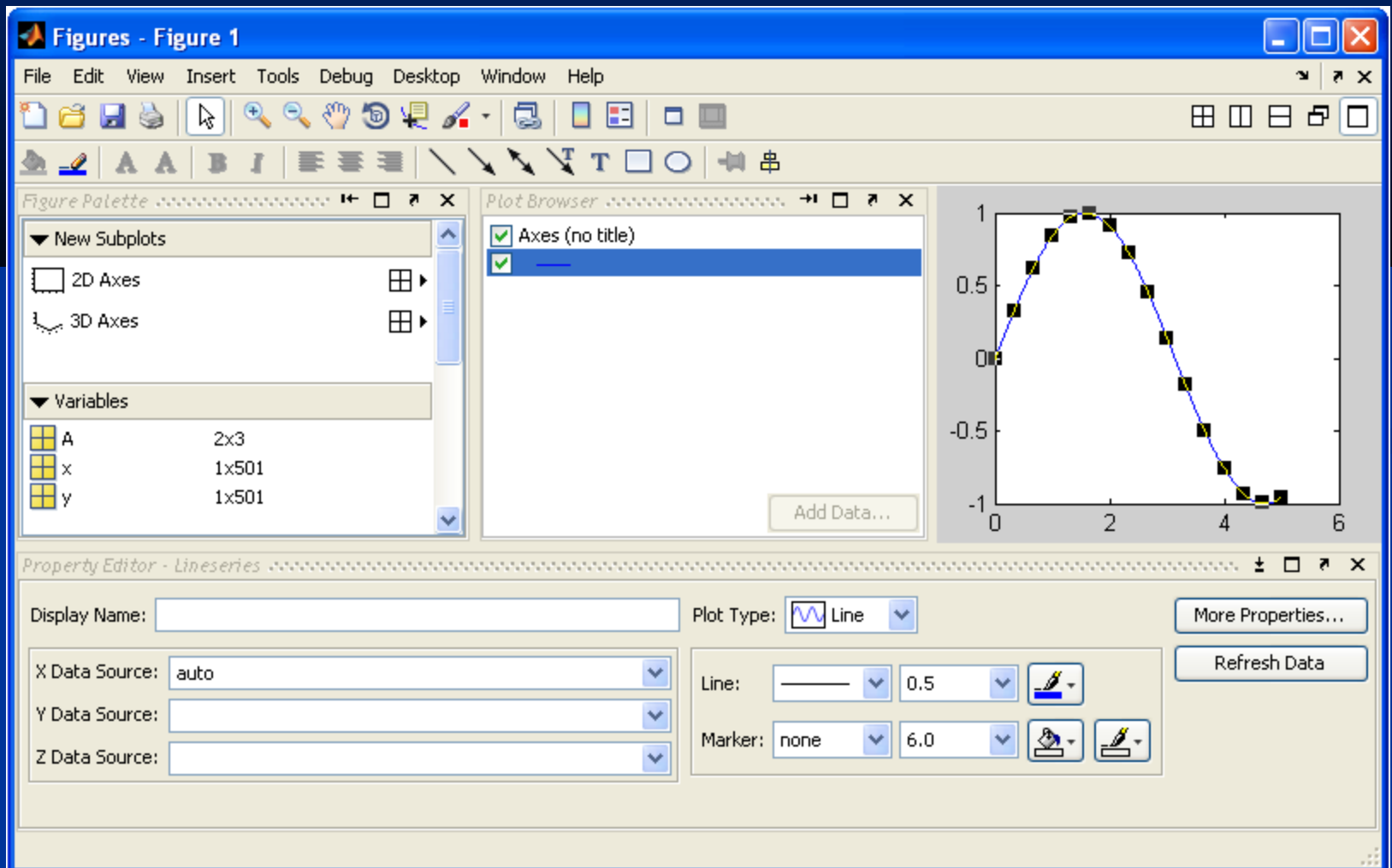

## Three-Dimensional Line Plots:

The following program uses the `plot3` function to generate the spiral curve shown in Figure 5.4–1, page 247.

```
>>t = 0:pi/50:10*pi;  
>>plot3(exp(-0.05*t).*sin(t),...  
        exp(-0.05*t).*cos(t),t),...  
        xlabel('x'),ylabel('y'),zlabel('z'),grid
```

See the next slide.



The curve  $x = e^{-0.05t} \sin t$ ,  $y = e^{-0.05t} \cos t$ ,  $z = t$  plotted with the `plot3` function. Figure 5.4–1, page 247.

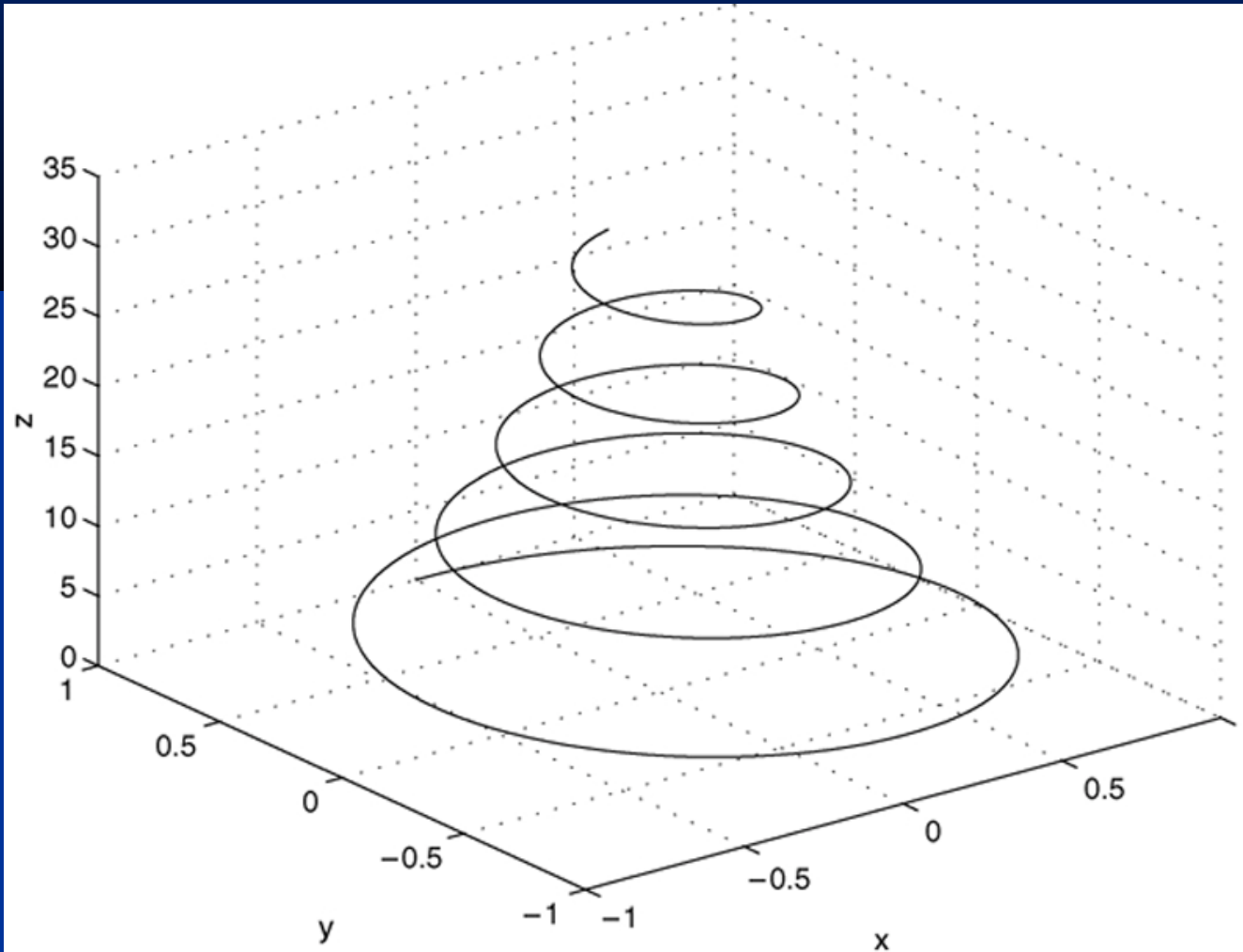

## Surface Plots:

The following session shows how to generate the surface plot of the function  $z = xe^{-[(x-y^2)^2+y^2]}$ , for  $-2 \leq x \leq 2$  and  $-2 \leq y \leq 2$ , with a spacing of 0.1. This plot appears in Figure 5.4–2, page 248.

```
>>[X,Y] = meshgrid(-2:0.1:2);  
>>Z = X.*exp(-((X-Y.^2).^2+Y.^2));  
>>mesh(X,Y,Z),xlabel('x'),ylabel('y'),...  
        zlabel('z')
```

See the next slide.

A plot of the surface  $z = xe^{-[(x-y^2)^2 + y^2]}$  created with the mesh function. Figure 5.8–2

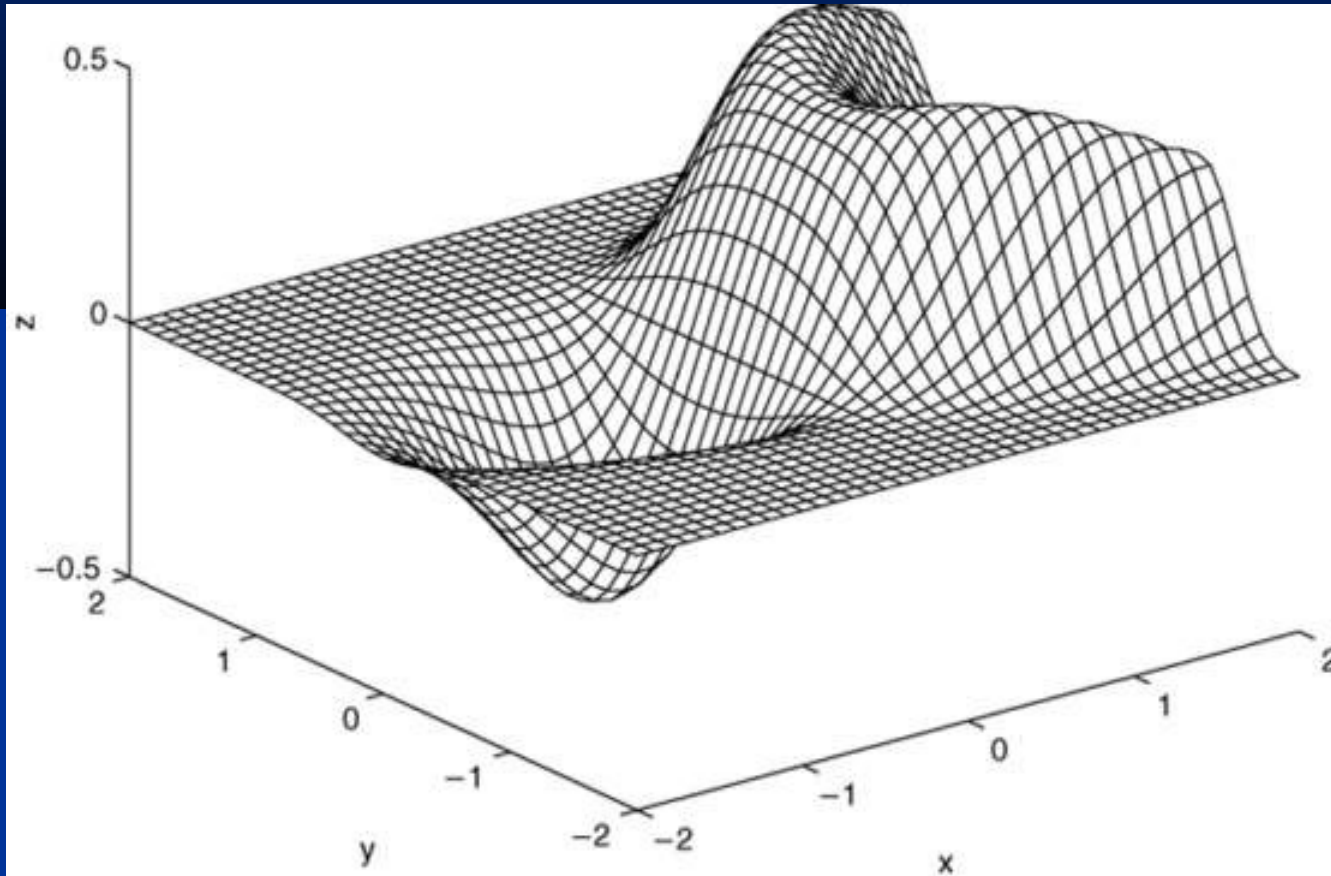

The following session generates the contour plot of the function whose surface plot is shown in Figure 5.8–2; namely,  $z = xe^{-[(x-y^2)^2+y^2]}$ , for  $-2 \leq x \leq 2$  and  $-2 \leq y \leq 2$ , with a spacing of 0.1. This plot appears in Figure 5.4–3, page 249.

```
>>[X,Y] = meshgrid(-2:0.1:2);  
>>Z = X.*exp(-((X- Y.^2).^2+Y.^2));  
>>contour(X,Y,Z),xlabel('x'),ylabel('y')
```

See the next slide.

A contour plot of the surface  $z = xe^{-[(x-y^2)^2 + y^2]}$  created with the contour function. Figure 5.4–3

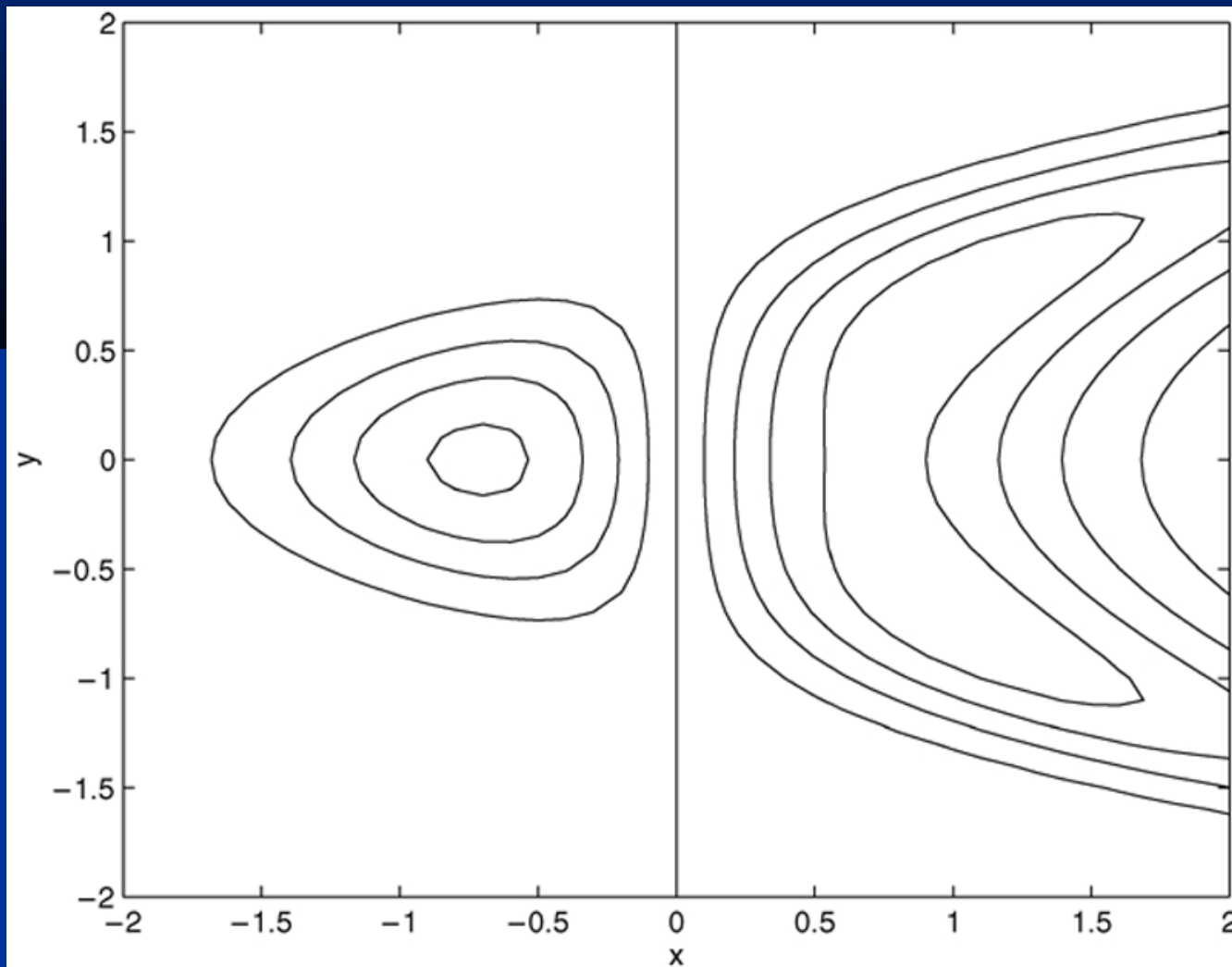

## Three-dimensional plotting functions. Table 5.4–1, page 250.

Function	Description
<code>contour(x, y, z)</code>	Creates a contour plot.
<code>mesh(x, y, z)</code>	Creates a 3D mesh surface plot.
<code>meshc(x, y, z)</code>	Same as <code>mesh</code> but draws contours under the surface.
<code>meshz(x, y, z)</code>	Same as <code>mesh</code> but draws vertical reference lines under the surface.
<code>surf(x, y, z)</code>	Creates a shaded 3D mesh surface plot.
<code>surfc(x, y, z)</code>	Same as <code>surf</code> but draws contours under the surface.
<code>[X, Y] = meshgrid(x, y)</code>	Creates the matrices <code>X</code> and <code>Y</code> from the vectors <code>x</code> and <code>y</code> to define a rectangular grid.
<code>[X, Y] = meshgrid(x)</code>	Same as <code>[X, Y] = meshgrid(x, x)</code> .
<code>waterfall(x, y, z)</code>	Same as <code>mesh</code> but draws mesh lines in one direction only.

Plots of the surface  $z = xe^{-(x^2+y^2)}$  created with the mesh function and its variant forms: meshc, meshz, and waterfall. a) mesh, b) meshc, c) meshz, d) waterfall. Figure 5.4–4, page 250.

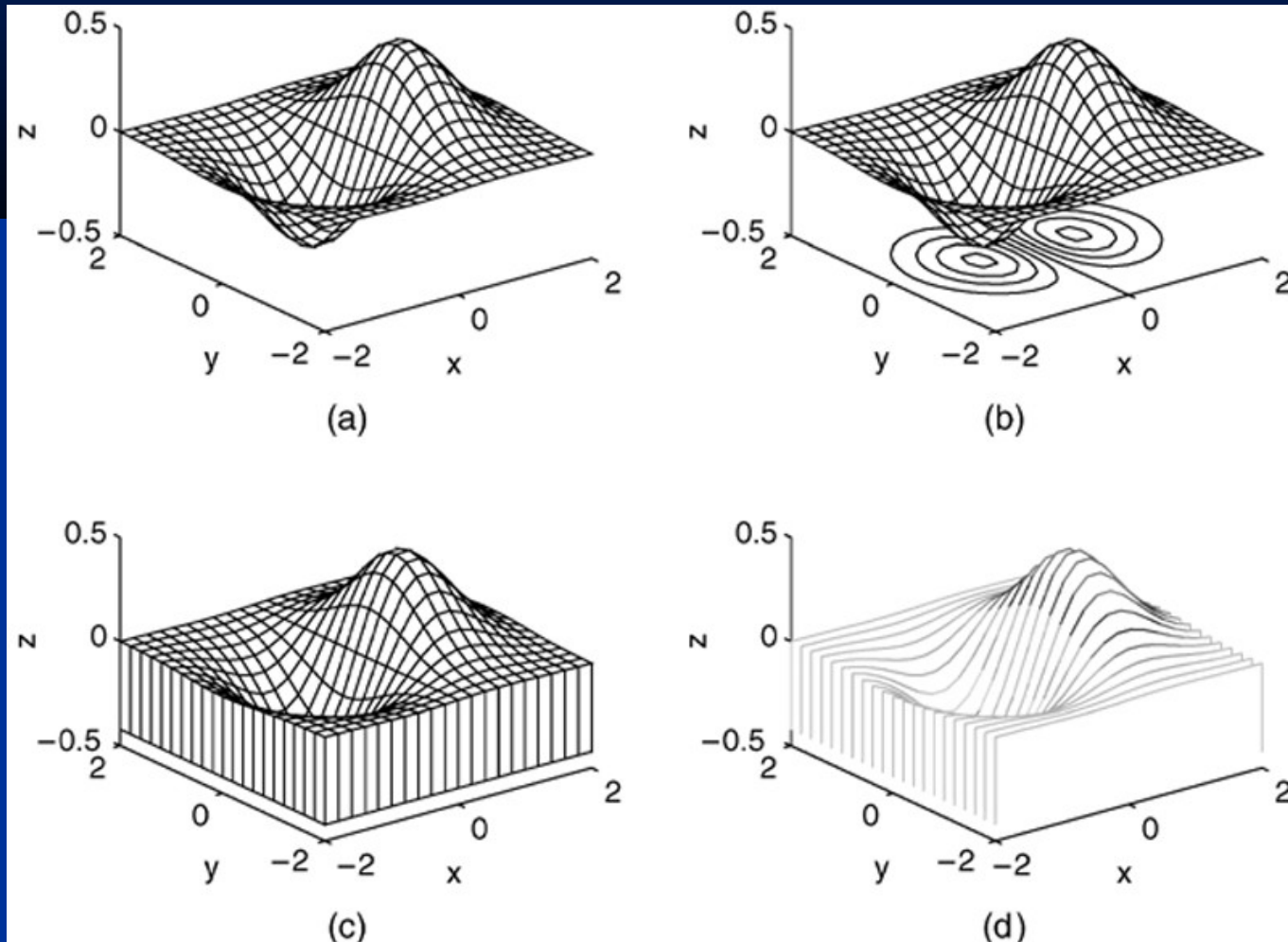

**The following slides contain the figures from  
the homework problems.**



Graphical solution of equations: Circuit representation of a power supply and a load. Figure P25, page 257.

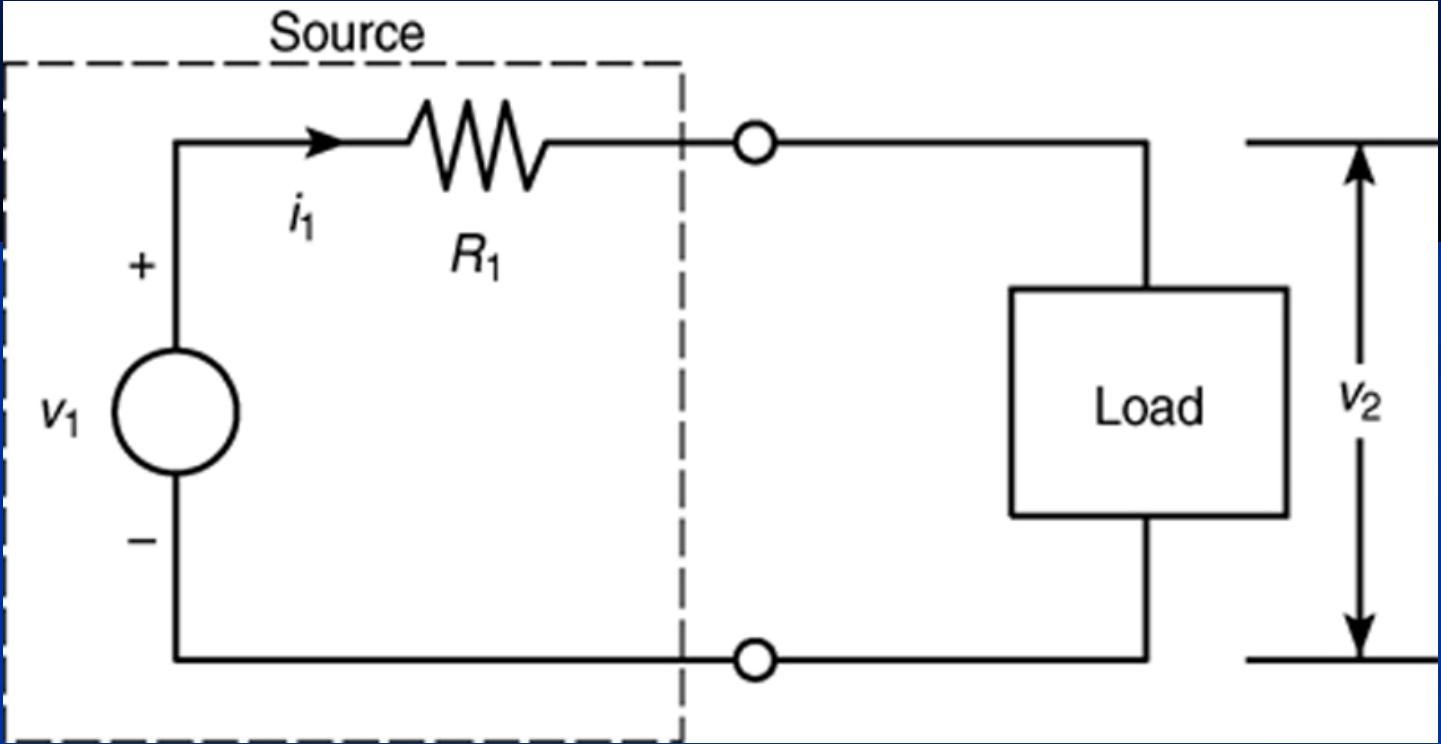

Figure P26 on page 257.

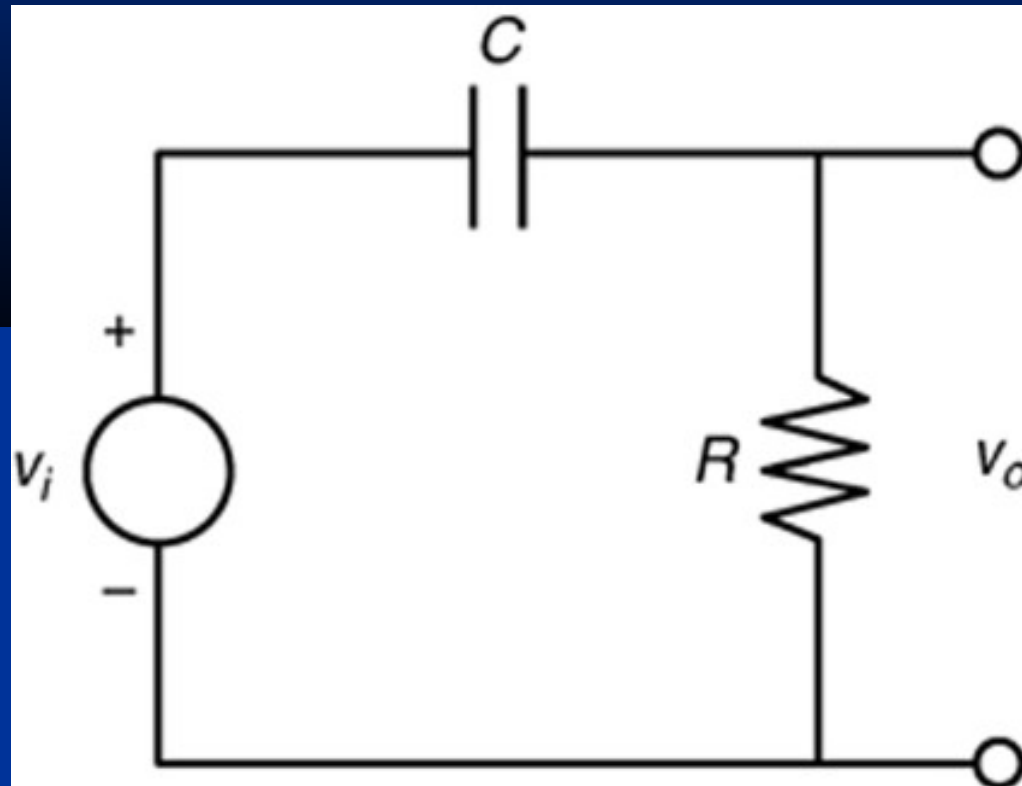

Figure P35 on page 260.

