

# Solid State Physics [3C25]

Tony Harker, Chiranjib Mitra and Andrew Horsfield

7th September 2004

# Contents

- 1 Crystal Structures** **12**
- 1.1 Preliminaries 12
  - 1.1.1 Required Knowledge 12
  - 1.1.2 Reading 12
- 1.2 What is special about crystals? 12
- 1.3 What does this suggest about their structure? 13
- 1.4 Artistic Example 15
- 1.5 Formal description 16
  - 1.5.1 The Lattice 16
  - 1.5.2 Lattice vectors 16
  - 1.5.3 The Unit Cell 16
  - 1.5.4 Number of lattice points in cell 18
  - 1.5.5 Wigner-Seitz cell 20
  - 1.5.6 Five Lattices in Two Dimensions 22
  - 1.5.7 Fourteen Lattices in Three Dimensions 22
  - 1.5.8 Cubic Unit Cells 23
  - 1.5.9 Length Scale 25
  - 1.5.10 Cell Volume 25
  - 1.5.11 The basis 25

- 1.5.12 Monatomic crystals . . . . . 25
- 1.6 Planar Hexagonal . . . . . 26
- 1.7 Cubic crystals . . . . . 28
  - 1.7.1 Sodium Chloride . . . . . 28
  - 1.7.2 Caesium Chloride . . . . . 29
- 1.8 Planes, Lines etc . . . . . 30
  - 1.8.1 Miller Indices . . . . . 30
  - 1.8.2 Directions . . . . . 32
  - 1.8.3 Symmetry-related sets . . . . . 32
  - 1.8.4 Spacing between planes . . . . . 32
  - 1.8.5 Angles between planes . . . . . 33
  - 1.8.6 More Examples . . . . . 33
- 1.9 Packing Fractions . . . . . 35
  - 1.9.1 Simple cubic . . . . . 35
  - 1.9.2 Body-centred cubic . . . . . 35
  - 1.9.3 Face-centred cubic . . . . . 35
  - 1.9.4 Hexagonal close-packed . . . . . 35
- 1.10 Defects . . . . . 36
  - 1.10.1 Point defects . . . . . 36
  - 1.10.2 Dislocations . . . . . 36
  - 1.10.3 Planar defects . . . . . 38
  - 1.10.4 Amorphous Solids . . . . . 39
- 2 Crystal Diffraction 41**
- 2.1 Preliminaries . . . . . 41
  - 2.1.1 Required Knowledge . . . . . 41
  - 2.1.2 Reading . . . . . 41
- 2.2 Bragg's Law . . . . . 41
- 2.3 Wavelengths and Energies . . . . . 43
  - 2.3.1 X-ray sources . . . . . 43
  - 2.3.2 Electron sources . . . . . 44

- 2.3.3 Neutron sources . . . . . 44
- 2.4 Elastic Scattering . . . . . 44
  - 2.4.1 Example . . . . . 45
- 2.5 Experimental Methods . . . . . 45
  - 2.5.1 Laue Method . . . . . 45
  - 2.5.2 Rotating Crystal Method . . . . . 47
  - 2.5.3 Powder Methods . . . . . 47
- 2.6 Mathematics of Diffraction . . . . . 47
  - 2.6.1 Monatomic Structure . . . . . 47
  - 2.6.2 The Reciprocal Lattice . . . . . 48
  - 2.6.3 The Scattered Amplitude . . . . . 49
- 2.7 The Laue Construction . . . . . 49
- 2.8 Non-Monatomic Structures . . . . . 50
  - 2.8.1 Simple Treatment . . . . . 50
  - 2.8.2 Detailed Treatment . . . . . 51
    - 2.8.2.1 Example – bcc structure . . . . . 52
- 2.9 Other Information . . . . . 52

**3 Bonding in Crystals 53**

- 3.1 Preliminaries . . . . . 53
  - 3.1.1 Required Knowledge . . . . . 53
  - 3.1.2 Reading . . . . . 53
- 3.2 Types of Bond . . . . . 54
- 3.3 Interatomic Potential Curves . . . . . 55
- 3.4 van der Waals Interaction . . . . . 56
  - 3.4.1 Short-range repulsion . . . . . 56
- 3.5 van der Waals Solids . . . . . 57
  - 3.5.1 Energy of van der Waals Solid . . . . . 57
  - 3.5.2 Equilibrium Separation . . . . . 58
  - 3.5.3 Choice of Structure . . . . . 59
  - 3.5.4 Bulk Modulus . . . . . 59

- 3.6 Ionic Crystals . . . . . 60
  - 3.6.1 Ionic Radii and Packing . . . . . 60
  - 3.6.2 Ionic Lattice Sums . . . . . 61
  - 3.6.3 Linear Chain . . . . . 61
  - 3.6.4 Three dimensions . . . . . 61
  - 3.6.5 Ionic Structures . . . . . 62
- 3.7 Metallic Bonding . . . . . 62
- 3.8 Covalent Bonding . . . . . 64
- 4 Dynamics of Crystals . . . . . 66**
  - 4.1 Preliminaries . . . . . 66
    - 4.1.1 Required Knowledge . . . . . 66
    - 4.1.2 Reading . . . . . 66
  - 4.2 Introduction . . . . . 66
  - 4.3 Chains of Atoms . . . . . 67
    - 4.3.1 Longitudinal Waves on Linear Chain . . . . . 67
    - 4.3.2 The Brillouin Zone . . . . . 69
    - 4.3.3 More than one atom per cell . . . . . 70
    - 4.3.4 Degenerate case of diatomic chain . . . . . 71
    - 4.3.5 Three dimensions . . . . . 71
    - 4.3.6 Measuring Phonon Spectra . . . . . 72
  - 4.4 Normal Modes . . . . . 73
  - 4.5 Phonon Density of States . . . . . 74
    - 4.5.1 One Dimension -  $g(k)$  . . . . . 74
    - 4.5.2 Assumption of Continuous Energy . . . . . 74
    - 4.5.3 One Dimension:  $g(E)$  or  $g(\omega)$  . . . . . 75
  - 4.6 Three dimensions -  $g(E)$  or  $g(\omega)$  . . . . . 76
    - 4.6.1 Special case - single frequency . . . . . 77
    - 4.6.2 Quantised Simple Harmonic Oscillator . . . . . 78
  - 4.7 Experimental Specific Heats . . . . . 80
  - 4.8 Einstein's model . . . . . 81

- 4.9 Debye Theory . . . . . 84
  - 4.9.1 The Debye Frequency . . . . . 85
  - 4.9.2 Debye specific heat . . . . . 85
  - 4.9.3 Debye model: high T . . . . . 86
  - 4.9.4 Debye model: low T . . . . . 87
  - 4.9.5 Successes and shortcomings . . . . . 87
- 4.10 Lattice Thermal Conductivity . . . . . 89
  - 4.10.1 Experimental values . . . . . 89
  - 4.10.2 Phonons as particles . . . . . 90
  - 4.10.3 Phonon momentum . . . . . 90
  - 4.10.4 Phonon interactions . . . . . 91
  - 4.10.5 Heat Transport . . . . . 91
  - 4.10.6 Boundary scattering . . . . . 92
  - 4.10.7 Point defect scattering . . . . . 92
  - 4.10.8 Phonon-phonon scattering . . . . . 92
  - 4.10.9 Combined processes . . . . . 93
- 5 Electrons in Solids - Overview 97**
  - 5.1 Experimental values . . . . . 97
    - 5.1.1 Electrical Resistivity . . . . . 97
    - 5.1.2 Magnetic properties . . . . . 99
    - 5.1.3 Miscellaneous properties . . . . . 100
  - 5.2 Theory . . . . . 100
- 6 The Free Electron Model 103**
  - 6.1 Preliminaries . . . . . 103
    - 6.1.1 Required Knowledge . . . . . 103
    - 6.1.2 Reading . . . . . 103
  - 6.2 Basic Features . . . . . 103
    - 6.2.1 Constant Potential . . . . . 103
    - 6.2.2 Free Electron Fermi Gas . . . . . 106

- 6.2.3 The Fermi Energy . . . . . 107
- 6.2.4 Orders of magnitude . . . . . 107
- 6.2.5 The Fermi surface . . . . . 108
- 6.3 Some simple properties of the free electron gas . . . . . 109
  - 6.3.1 Thermionic emission . . . . . 109
  - 6.3.2 Field emission . . . . . 109
  - 6.3.3 Photoemission . . . . . 111
  - 6.3.4 X-ray emission (Auger spectroscopy) . . . . . 111
  - 6.3.5 Contact potential . . . . . 112
- 6.4 Thermal Behaviour of free electron gas . . . . . 112
  - 6.4.1 Review of Fermi function . . . . . 112
  - 6.4.2 Electronic specific heat . . . . . 113
  - 6.4.3 Experimental results . . . . . 114
- 6.5 Electrical Conductivity . . . . . 115
  - 6.5.1 Classical treatment . . . . . 115
  - 6.5.2 Relaxation time . . . . . 115
  - 6.5.3 Electrical conductivity . . . . . 116
  - 6.5.4 Experimental results . . . . . 116
- 6.6 Electronic Thermal Conductivity . . . . . 117
  - 6.6.1 The Wiedemann-Franz law . . . . . 117
- 6.7 Conductivity – the view from reciprocal space . . . . . 118
  - 6.7.1 Electrical conductivity . . . . . 118
  - 6.7.2 Thermal conductivity . . . . . 118
  - 6.7.3 Contributions to scattering . . . . . 119
- 6.8 Plasma Oscillations . . . . . 121
- 6.9 The Hall Effect . . . . . 122
- 6.10 Free electron approximation – final comments . . . . . 123
  - 6.10.1 Screening . . . . . 124
  - 6.10.2 Electron-electron scattering . . . . . 124
  - 6.10.3 Binding energy of metals . . . . . 124

**7 Electrons in Periodic Structures 125**

- 7.1 Preliminaries . . . . . 125
  - 7.1.1 Required Knowledge . . . . . 125
  - 7.1.2 Reading . . . . . 125
- 7.2 Introduction . . . . . 125
- 7.3 Bloch’s theorem . . . . . 126
- 7.4 The Nearly Free Electron model . . . . . 127
  - 7.4.1 Basic ideas . . . . . 127
  - 7.4.2 Perturbation theory . . . . . 127
  - 7.4.3 Fourier Analysis . . . . . 128
  - 7.4.4 The Energy Gap . . . . . 128
- 7.5 An exactly-soluble model . . . . . 129
- 7.6 Sketching energy bands . . . . . 130
  - 7.6.1 The empty lattice . . . . . 130
  - 7.6.2 The nearly free electron . . . . . 130
- 7.7 Consequences of the energy gap . . . . . 130
  - 7.7.1 Density of states . . . . . 130
  - 7.7.2 States in one dimension . . . . . 131
  - 7.7.3 Sketching a nearly free electron Fermi surface . . . . . 135
  - 7.7.4 Typical Fermi surfaces in 3D . . . . . 136
  - 7.7.5 Effects of fields on electrons in bands . . . . . 138
- 7.8 The tight-binding model . . . . . 141
  - 7.8.1 Overview . . . . . 142
  - 7.8.2 Tight-binding theory . . . . . 143
  - 7.8.3 Comments on tight binding theory . . . . . 145

**8 Electrons and Holes 146**

- 8.1 Preliminaries . . . . . 146
  - 8.1.1 Required Knowledge . . . . . 146
  - 8.1.2 Reading . . . . . 146
- 8.2 Equations of motion . . . . . 146



- 8.3 Effective mass . . . . . 147
  - 8.3.1 Typical effective masses for semiconductors . . . . . 150
- 8.4 Electrons and holes . . . . . 150
  - 8.4.1 Hole wavevector . . . . . 151
  - 8.4.2 Hole energy . . . . . 151
  - 8.4.3 Hole velocity . . . . . 151
  - 8.4.4 Hole effective mass . . . . . 151
  - 8.4.5 Hole dynamics . . . . . 152
  - 8.4.6 Experimental . . . . . 152
  - 8.4.7 Mobility and conductivity . . . . . 152

**9 Physics of Semiconductors 153**

- 9.1 Preliminaries . . . . . 153
  - 9.1.1 Required Knowledge . . . . . 153
  - 9.1.2 Reading . . . . . 153
- 9.2 Creating free carriers . . . . . 153
- 9.3 Photon absorption . . . . . 153
- 9.4 Thermal excitation . . . . . 154
  - 9.4.1 Law of mass action . . . . . 155
- 9.5 Parabolic bands . . . . . 156
- 9.6 Intrinsic behaviour . . . . . 157
- 9.7 Doping - donors and acceptors . . . . . 158
  - 9.7.1 Impurity states . . . . . 158
  - 9.7.2 Typical binding energies . . . . . 159
  - 9.7.3 Deep traps . . . . . 160
  - 9.7.4 Locating the chemical potential . . . . . 160
- 9.8 Carrier concentrations . . . . . 161
  - 9.8.1 Overview . . . . . 161
  - 9.8.2 Detailed results . . . . . 163
- 9.9 Mobility and conductivity . . . . . 163
  - 9.9.1 Scattering by charged impurities . . . . . 163

- 9.9.2 Scattering by phonons . . . . . 164
- 9.9.3 Overall effect . . . . . 164
- 9.9.4 Hall effect in semiconductors . . . . . 165
- 9.9.5 Cyclotron resonance . . . . . 166
- 9.10 Carrier diffusion and recombination . . . . . 167
  - 9.10.1 Recombination . . . . . 167
  - 9.10.2 Diffusion . . . . . 168
  - 9.10.3 Electric current . . . . . 168
- 9.11 Heterojunctions . . . . . 169
  - 9.11.1 Junction transistor . . . . . 174
  - 9.11.2 Field effect transistor . . . . . 175
  - 9.11.3 Light-emitting diodes . . . . . 176
  - 9.11.4 Solar cells . . . . . 177

**10 Magnetic Materials 178**

- 10.1 Preliminaries . . . . . 178
  - 10.1.1 Required Knowledge . . . . . 178
  - 10.1.2 Reading . . . . . 178
- 10.2 Introduction . . . . . 178
- 10.3 Magnetic properties - reminder . . . . . 179
- 10.4 Measuring magnetic properties . . . . . 180
  - 10.4.1 Force method . . . . . 180
  - 10.4.2 Vibrating Sample magnetometer . . . . . 181
- 10.5 Experimental data . . . . . 181
- 10.6 Diamagnetism . . . . . 181
- 10.7 Paramagnetism . . . . . 183
  - 10.7.1 Paramagnetism of spin- $\frac{1}{2}$  ions . . . . . 183
  - 10.7.2 General  $J$  ionic paramagnetism . . . . . 184
  - 10.7.3 States of ions in solids . . . . . 187
- 10.8 Interacting magnetic moments . . . . . 189
  - 10.8.1 Direct magnetic interaction . . . . . 190

- 10.8.2 Exchange interaction . . . . . 190
- 10.8.3 Effective field model . . . . . 191
- 10.8.4 The mean field approximation . . . . . 191
- 10.8.5 Mean field theory of ferromagnetism . . . . . 192
- 10.8.6 Paramagnetic regime . . . . . 194
- 10.8.7 Effect of magnetic field on ferromagnet . . . . . 195
- 10.8.8 Anisotropy in magnetic systems . . . . . 196
- 10.9 Magnetic domains . . . . . 196
  - 10.9.1 Magnetic field energy . . . . . 196
  - 10.9.2 Domain walls . . . . . 197
- 10.10 Other types of magnetic ordering . . . . . 198
- 10.11 Magnetic properties of metals . . . . . 199
  - 10.11.1 Free electron paramagnetism . . . . . 199
  - 10.11.2 Ferromagnetic metals . . . . . 200

**11 Superconductivity 202**

- 11.1 Preliminaries . . . . . 202
  - 11.1.1 Required Knowledge . . . . . 202
  - 11.1.2 Reading . . . . . 202
- 11.2 Basic experimental observations . . . . . 202
  - 11.2.1 Disappearance of resistance . . . . . 202
  - 11.2.2 Specific Heat . . . . . 205
  - 11.2.3 Effect of magnetic field . . . . . 205
  - 11.2.4 Perfect diamagnetism . . . . . 206
- 11.3 Basic thermodynamics . . . . . 207
  - 11.3.1 Specific heat . . . . . 208
  - 11.3.2 The shielding currents . . . . . 209
- 11.4 Phenomenological theories . . . . . 210
  - 11.4.1 Measurement of penetration depth . . . . . 210
- 11.5 Coherence . . . . . 211
- 11.6 Microscopic model . . . . . 212

- 11.6.1 The energy gap . . . . . 213
- 11.6.2 The wavefunction . . . . . 214
- 11.7 Experimental evidence for energy gap . . . . . 215
  - 11.7.1 Specific heat . . . . . 215
  - 11.7.2 Infrared absorption . . . . . 215
- 11.8 Tunnelling currents . . . . . 216
  - 11.8.1 Type I and type II behaviour . . . . . 217
- 11.9 High  $T_C$  materials . . . . . 218

# Chapter 1

## Crystal Structures

### 1.1 Preliminaries

#### 1.1.1 Required Knowledge

- ▶ Vectors (including scalar and vector products)
- ▶ Simple transformations (rotations and translations)
- ▶ Equation of a plane
- ▶ Volumes of cubes and spheres

#### 1.1.2 Reading

- ▶ Hook and Hall 1.1-1.3

### 1.2 What is special about crystals?

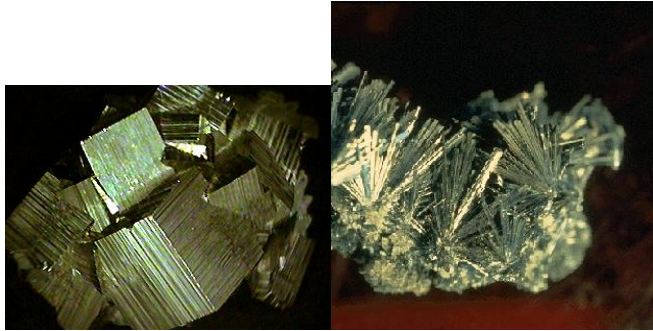
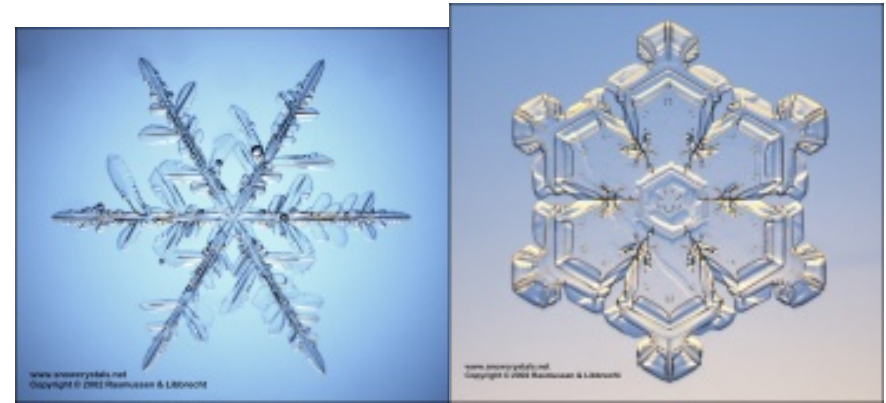

Crystals of native copper.

Crystals of pyrite ( $\text{FeS}_2$ ) and stibnite ( $\text{Sb}_2\text{S}_3$ ).Crystals of quartz ( $\text{SiO}_2$ ) - the original *κρυσταλλος*.

Snow crystals.

- ▶ precise symmetries
- ▶ flat surfaces
- ▶ straight edges
- ▶ Haüy's "Tout est trouvé!" on dropping iceland spar

### 1.3 What does this suggest about their structure?

Regular pattern of simple building blocks (Kepler, Robert Hooke, Huygens, Descartes).

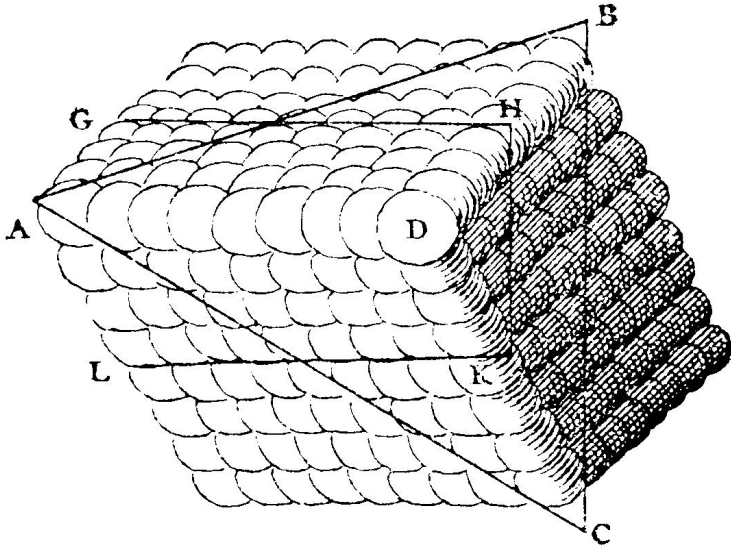
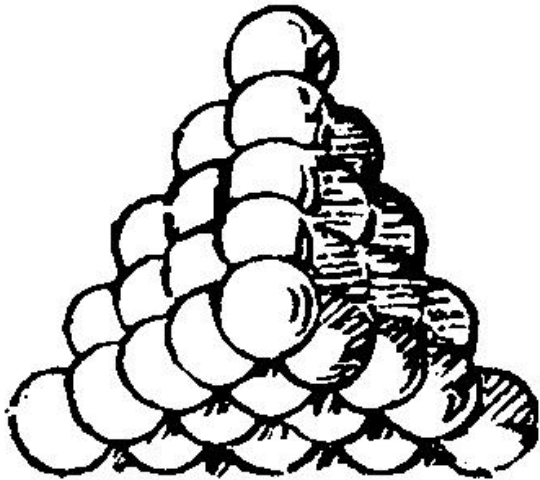

Christiaan Huygens's picture of a calcite ( $\text{CaCO}_3$ ) crystal made from spherical particles (*Traité de la Lumière*, Leiden 1690).

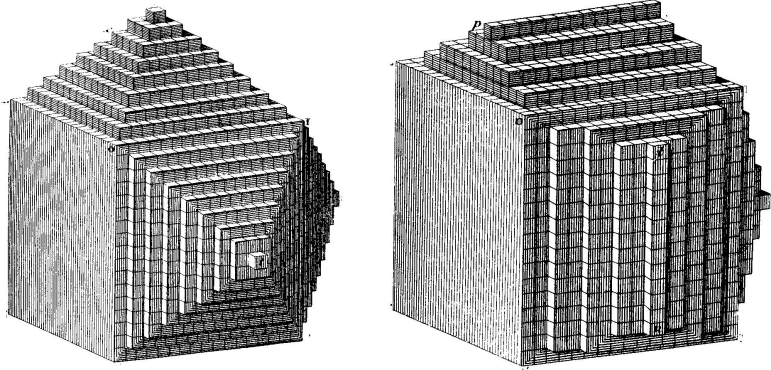

A crystal made from spherical particles, according to Robert Hooke (*Micrographia Restaurata*, London 1745).

A crystal structure as depicted by René Haüy (*Traité de Cristallographie*, Paris 1822).

### 1.4 Artistic Example

- ▶ motifs are assembled *periodically*
- ▶ the motifs are all in the same orientation
- ▶ note that the motif contains *two* knights

The plane is completely filled.

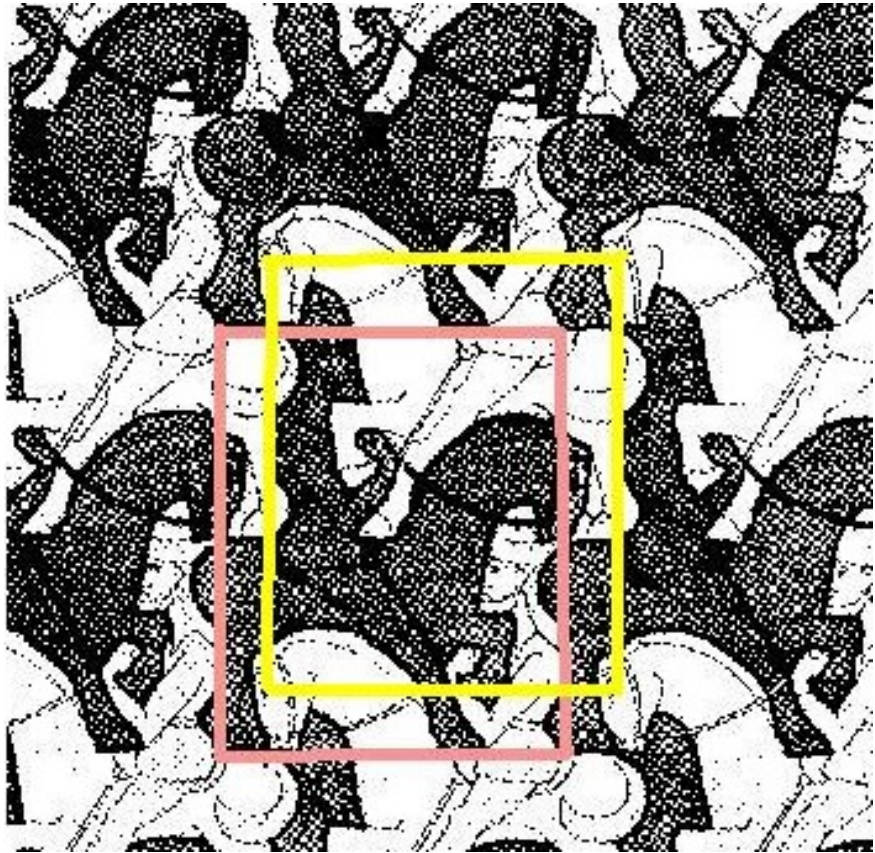
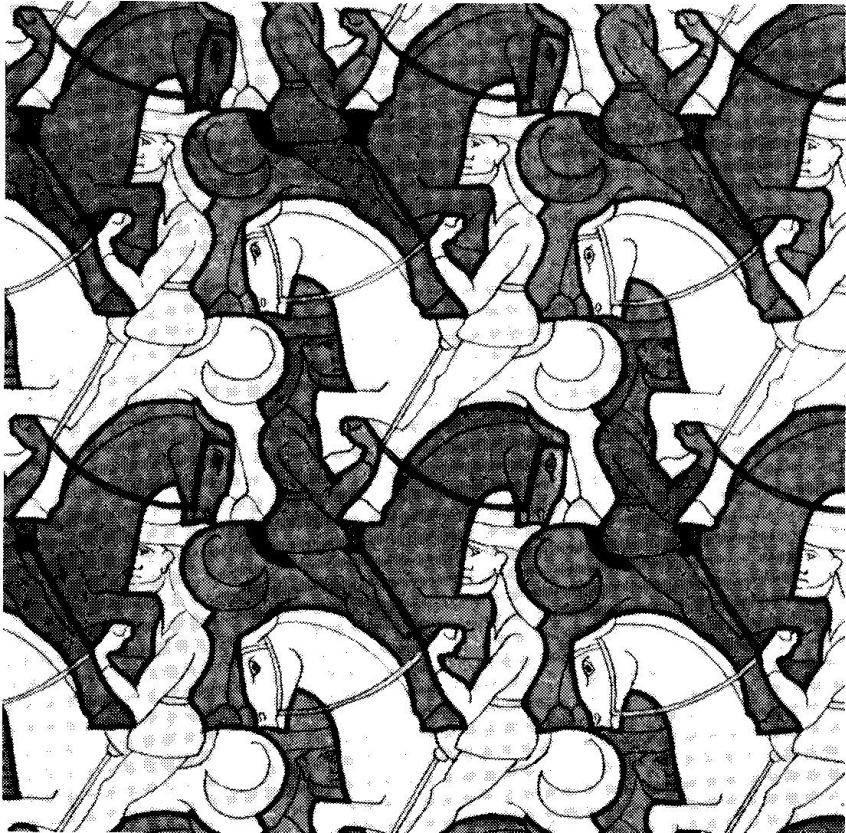

Figure shows engravings by M.C. Escher

The key points about building this pattern are that

We can pick a unit cell: but note



- ▶ the unit cell is not unique. For example, we could pick a cell with a white knight in the middle
- ▶ or we could pick a larger cell which could be a bigger square or a rectangle or other shape

## 1.5 Formal description

Separate the motif from the repetition pattern.

### 1.5.1 The Lattice

- ▶ A *lattice* is an arrangement of points in space such that the environment of any point is identical to that of any other point.
- ▶ Note: points, space – this is now a *mathematical problem*.
- ▶ The mathematicians tell us how many different lattice types there are in spaces of 2, 3,... dimensions. These are the *Bra-vaix lattices*.
- ▶ Lattices have symmetries, more fully *point group symmetries*, described in terms of rotations and reflections.
- ▶ Remember: the lattice is *not* the crystal – it's the collection of points in space on which the crystal is hung (but people often use the word lattice when they mean crystal).

### 1.5.2 Lattice vectors

- ▶ A *lattice vector* is any vector joining two lattice points.

- ▶ It is convenient to define a set of *primitive lattice vectors*: this is the set of the shortest linearly independent lattice vectors.

- ▶ Linear independence ensures that they can span all dimensions of the space - for example, in 2D they must not be parallel, and in 3D in addition they must not lie in the same plane.

- ▶ These vectors, conventionally referred to as **a**, **b** and **c**, allow us to start from any point on the lattice and generate the rest of the lattice points at  $n_1\mathbf{a} + n_2\mathbf{b} + n_3\mathbf{c}$  where  $n_1$ ,  $n_2$  and  $n_3$  are integers, running in principle from  $-\infty$  to  $+\infty$ .

### 1.5.3 The Unit Cell

A *unit cell* is a volume (area in 2D) which, when repeated by being translated by the lattice vectors, will fill all space.

N.B. *translated*, without rotation or change of shape.

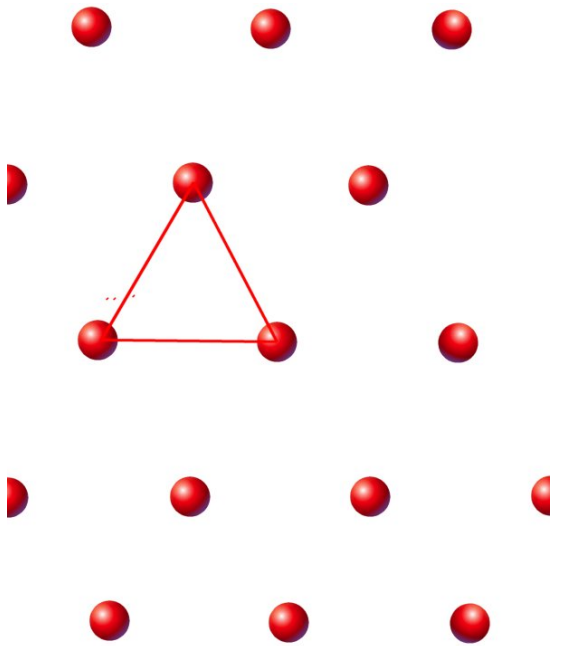
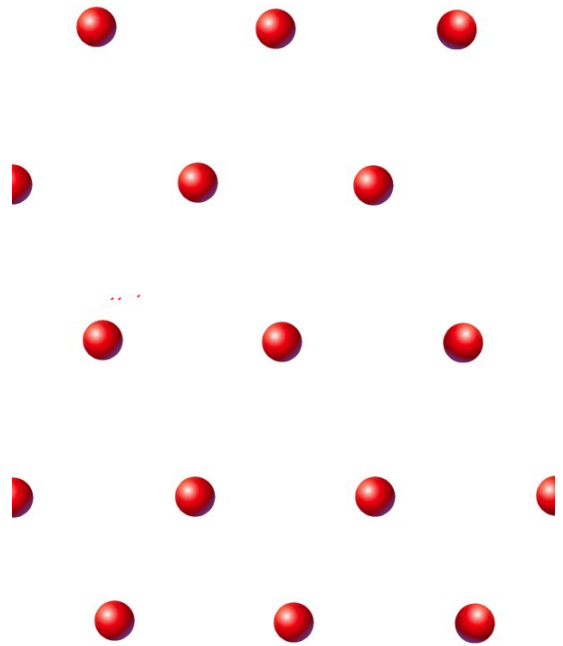

The triangular lattice - the dots represent *points*, not atoms.

The triangle is not a suitable unit cell,

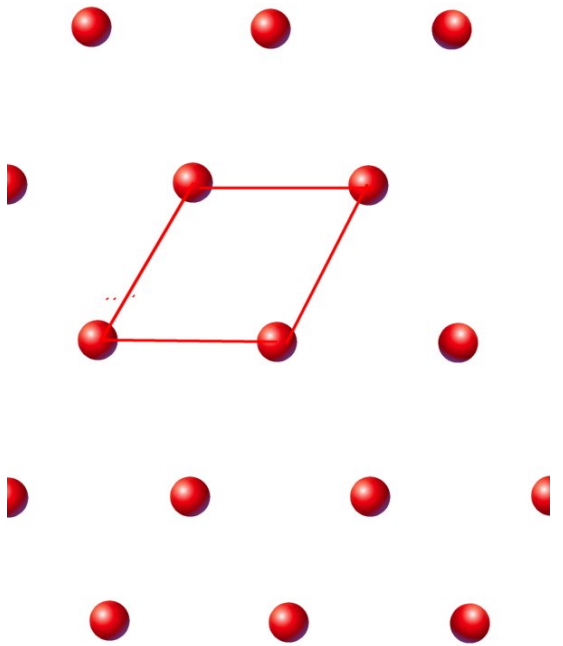
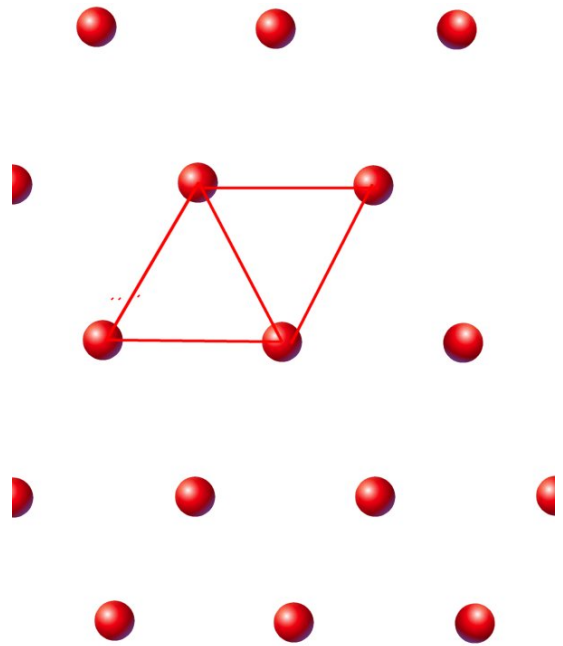

The rhombus is a suitable unit cell, the triangle is not.

### 1.5.4 Number of lattice points in cell

Two approaches:

- ▶ Count points, sharing face, edge and corner points
- ▶ Shift the cell so that all points are internal, then count

because we cannot fill space just by replicating it – we have to invert it.

Rectangular lattice (points have been given size to allow us to subdivide them)

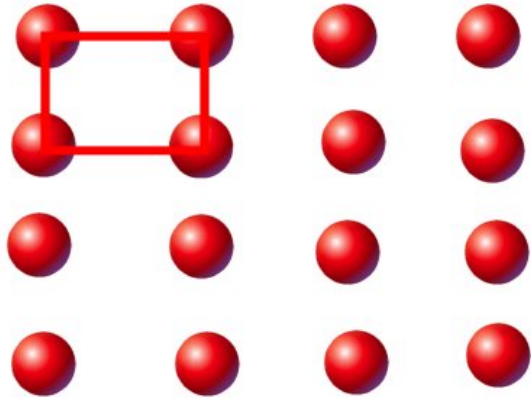
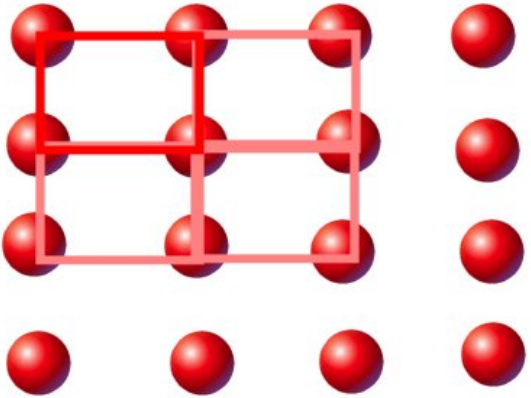
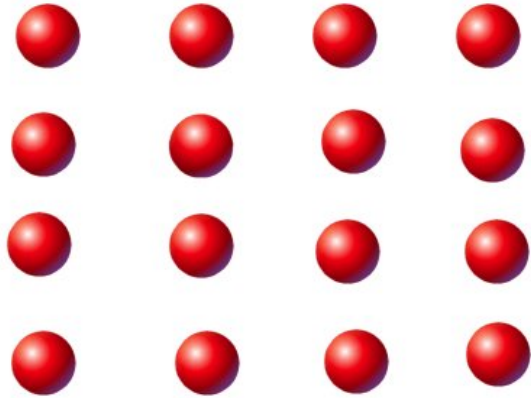

each corner point is shared

- ▶ Here, each point is shared with *four* neighbouring cells, so the cell contains  $4 \times \frac{1}{4} = 1$  point.
  
- ▶ We'll see later how to apply the same idea in three dimensions.
  
- ▶ Alternatively, we can take advantage of the fact that the unit cell is not uniquely defined, so we can shift it:

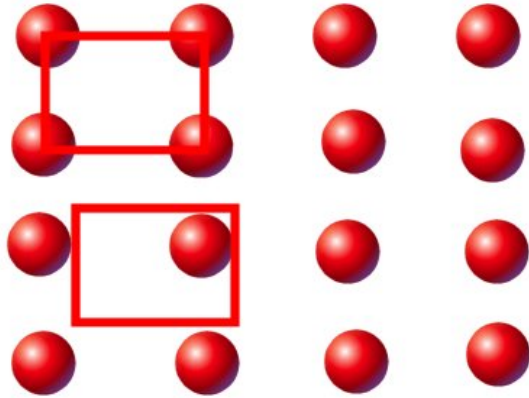

There is only one lattice point in the unit cell. This is a *primitive* unit cell.

### 1.5.5 Wigner-Seitz cell

Construction

- ▶ select a lattice point
- ▶ draw lines joining it to its neighbours
- ▶ draw perpendicular bisectors (planes in 3D, lines in 2D) of those lines
- ▶ the Wigner-Seitz cell is the volume (area in 2D) is the area within the bisectors.

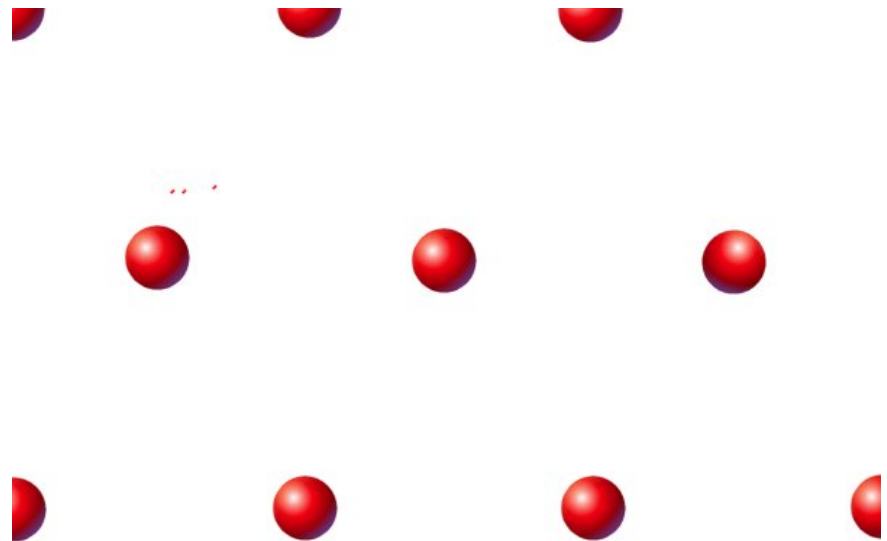

The triangular lattice.

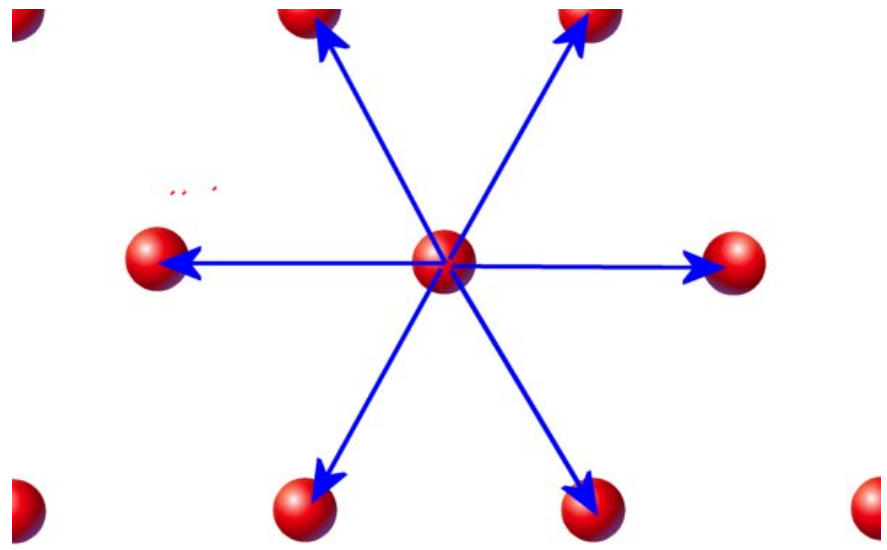

Join points to neighbours

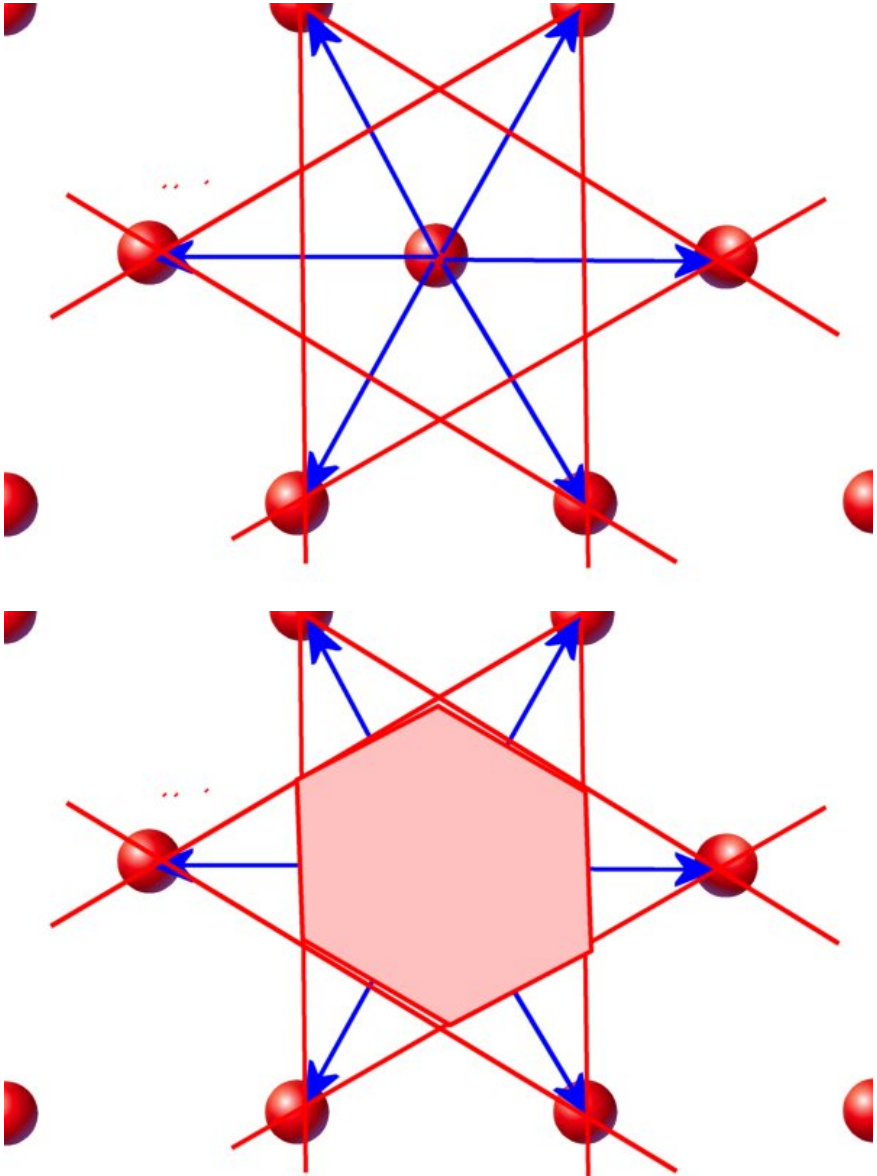
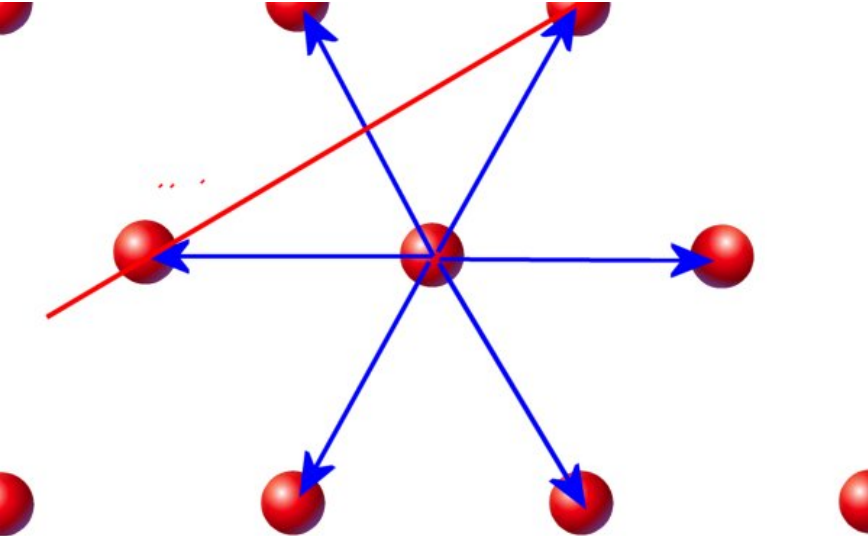

Draw perpendicular bisectors.

The Wigner-Seitz cell tends to show the symmetry of the lattice.

1.5.6 Five Lattices in Two Dimensions

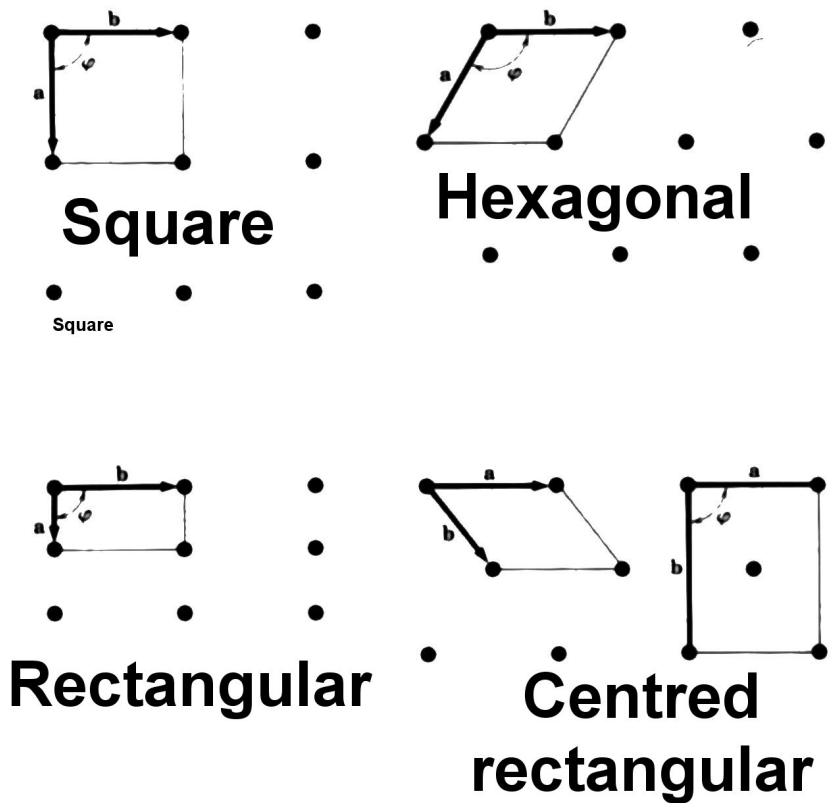

1.5.7 Fourteen Lattices in Three Dimensions

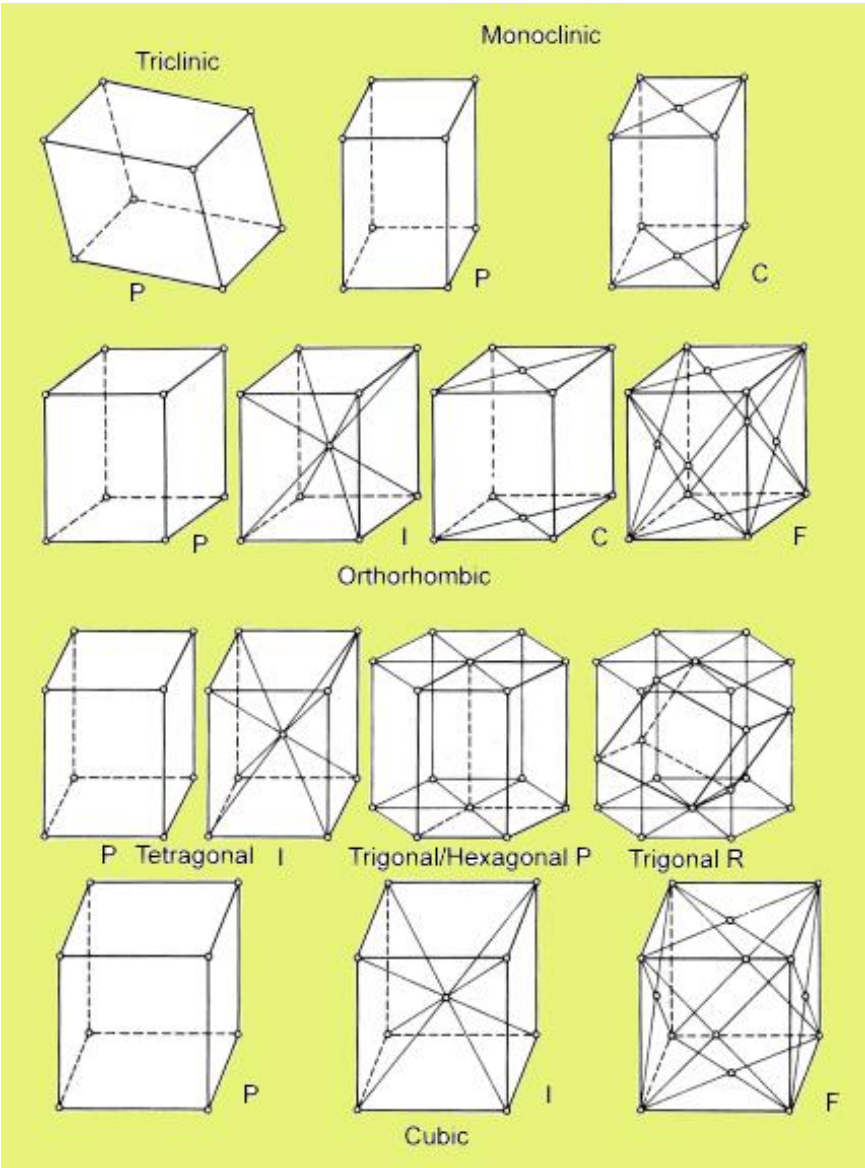

Lattice	Unit Cell	Restrictions	Symmetry
Oblique	Parallelogram	$a \neq b, \phi \neq 90^\circ$	2
Square	Square	$a = b, \phi = 90^\circ$	4mm
Hexagonal	60° Rhombus	$a = b, \phi = 120^\circ$	6mm
Primitive Rectangular	Rectangle	$a \neq b, \phi = 90^\circ$	2mm
Centred Rectangular	Rectangle	$a \neq b, \phi = 90^\circ$	2mm

System	Type	Restrictions
Triclinic	P	$a \neq b \neq c, \alpha \neq \beta \neq \gamma$
Monoclinic	P,C	$a \neq b \neq c, \alpha = \gamma = 90^\circ \neq \beta$
Orthorhombic	P,C,I,F	$a \neq b \neq c, \alpha = \beta = \gamma = 90^\circ$
Tetragonal	P,I	$a = b \neq c, \alpha = \beta = \gamma = 90^\circ$
Cubic	P,I,F <sup>1</sup>	$a = b = c, \alpha = \beta = \gamma = 90^\circ$
Trigonal	P	$a = b = c, \alpha = \beta = \gamma < 120^\circ, \neq 90^\circ$
Hexagonal	P	$a = b \neq c, \alpha = \beta = 90^\circ, \gamma = 120^\circ$

No need to learn details except for cubic, basic ideas of hexagonal.

**1.5.8 Cubic Unit Cells**

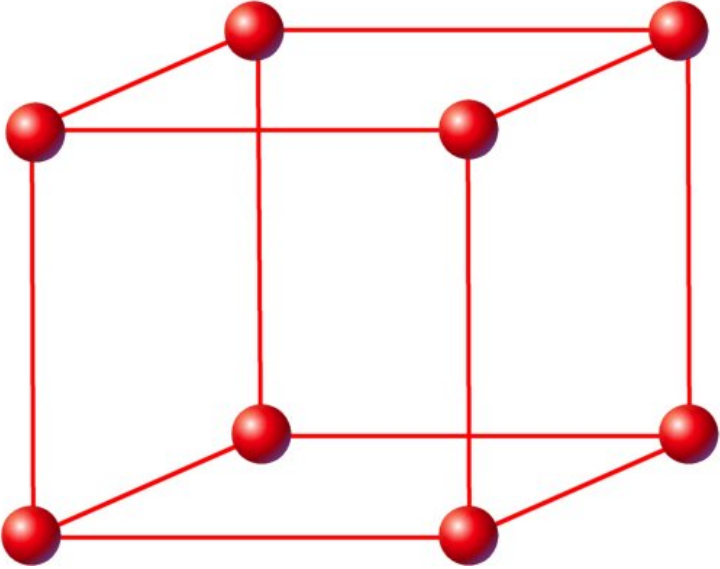

Simple cubic: cube containing one lattice point (or 8 corner points each shared among 8 cubes:  $8 \times \frac{1}{8} = 1$ ).

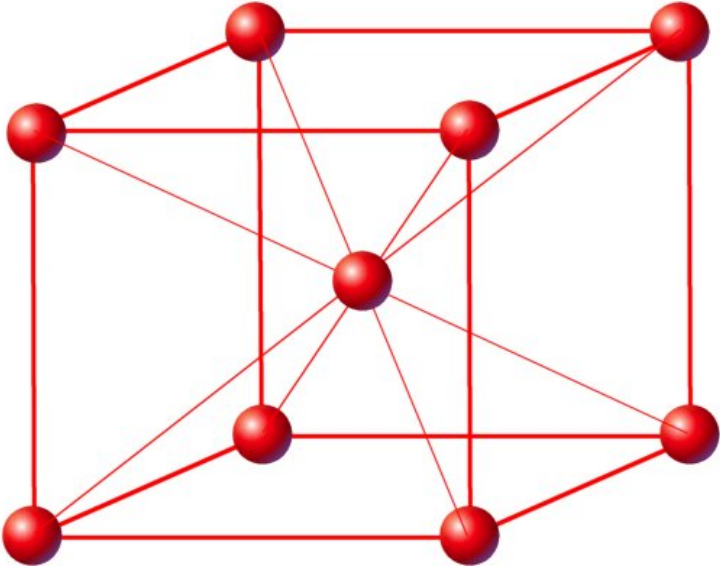

Body centred cubic: 2 points in cubic cell



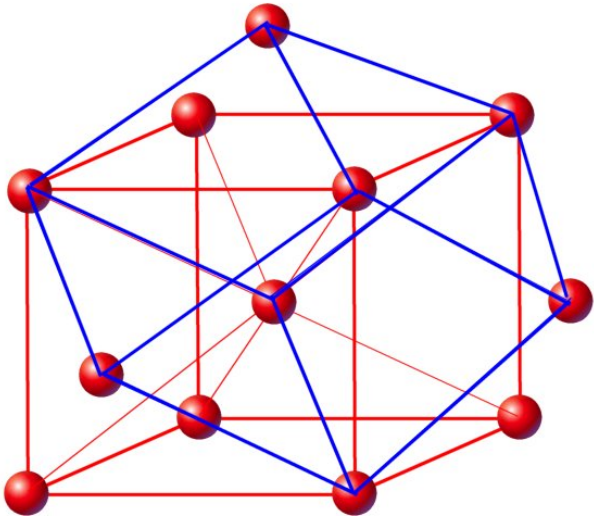

Rhombohedral primitive cell of body centred cubic system.

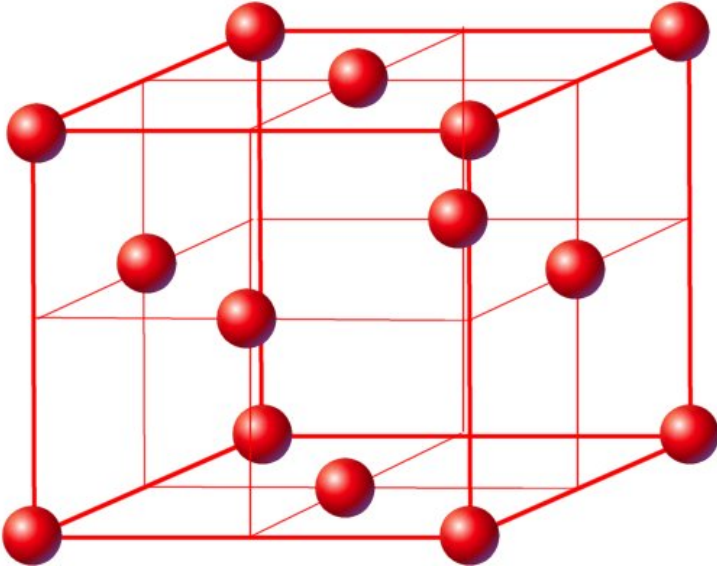

Face centred cubic: 4 points in cubic cell (8 corner points shared 8 ways, 6 face points shared 2 ways:  $8 \times \frac{1}{8} + 6 \times \frac{1}{2} = 4$ ).

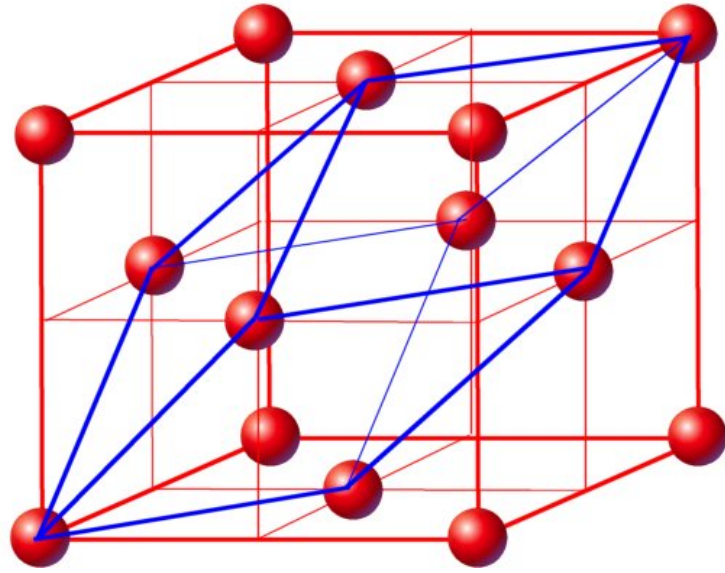

Rhombohedral primitive cell of face centred cubic system. We will work with non-primitive, conventional cubic cells.

### 1.5.9 Length Scale

Typical interatomic distance: a few Ångstroms, say 0.25 nm.

### 1.5.10 Cell Volume

- ▶ If the primitive lattice vectors are  $\underline{a}$ ,  $\underline{b}$  and  $\underline{c}$ , the cell volume is  $|\underline{a} \cdot \underline{b} \times \underline{c}|$ .
- ▶ The lengths of the lattice vectors,  $a = |\underline{a}|$  etc., are called the *lattice parameters*.
- ▶ For cubic crystals,  $a = b = c$ , so cell volume is  $a^3$ .

### 1.5.11 The basis

- ▶ So far we have been in the realm of abstract mathematics – now we need to attach the motif, the pattern itself, the atoms, to the lattice.
- ▶ The *basis* is the arrangement of atoms associated with each lattice point.
- ▶ Sometimes there is only one atom per lattice point – a *monatomic* lattice – but often there are more.
- ▶ Mathematically, this association of one copy of something with every point is a *convolution*.

### 1.5.12 Monatomic crystals

Some elements crystallize in forms with only one atom per unit cell:

- ▶ copper – face-centred cubic
- ▶ iron (at low temperatures) – body-centred cubic
- ▶ polonium – simple cubic

Face-centered cubic (FCC) and hexagonal close packed (HCP) crystals can be constructed by stacking cannon balls.

- ▶ FCC corresponds to ...*ABCABCABC*...
- ▶ HCP corresponds to ...*ABABABABA*...

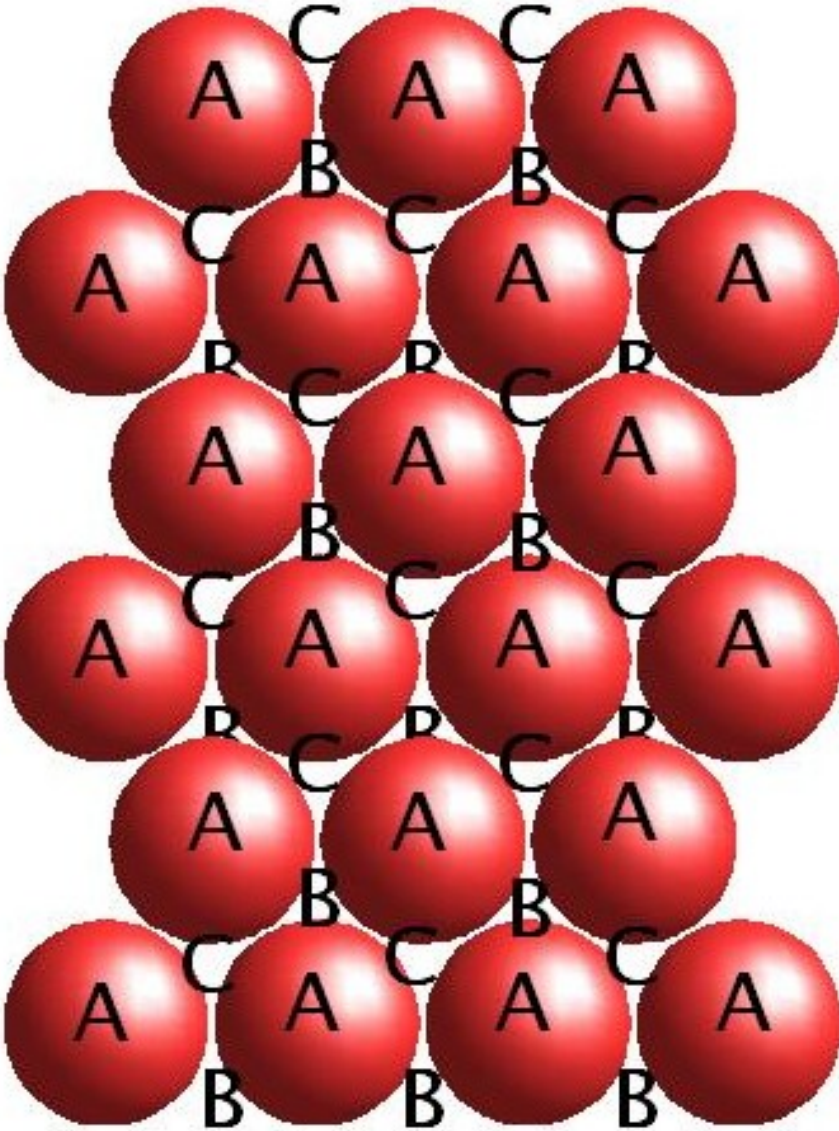

### 1.6 Planar Hexagonal

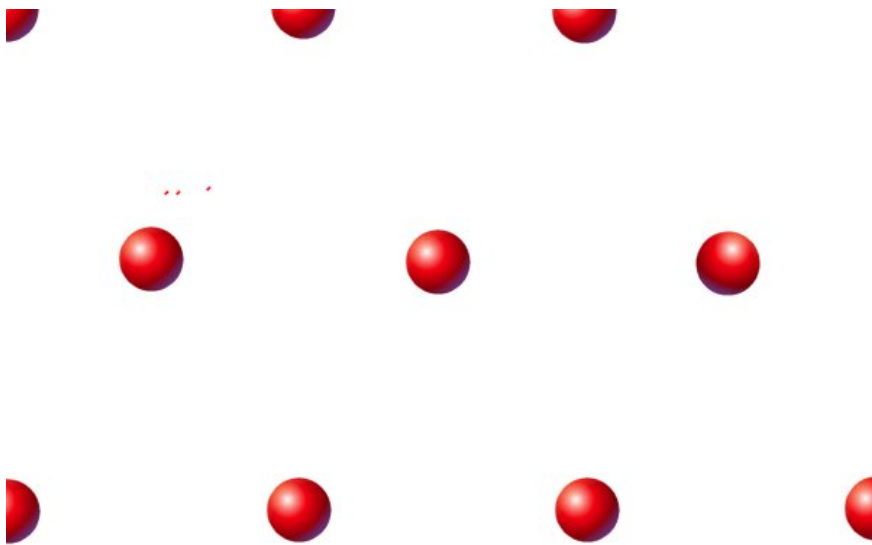

Each lattice point is hexagonally coordinated (six neighbours at equal distances)

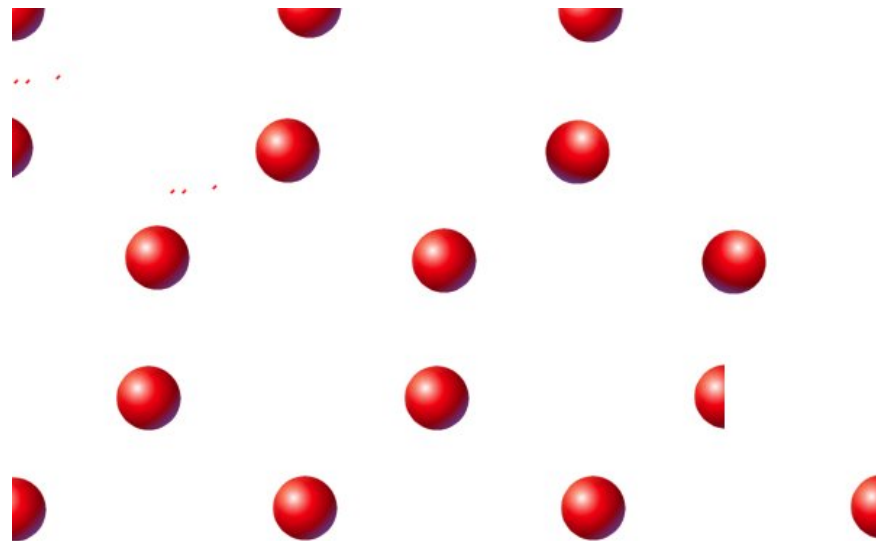
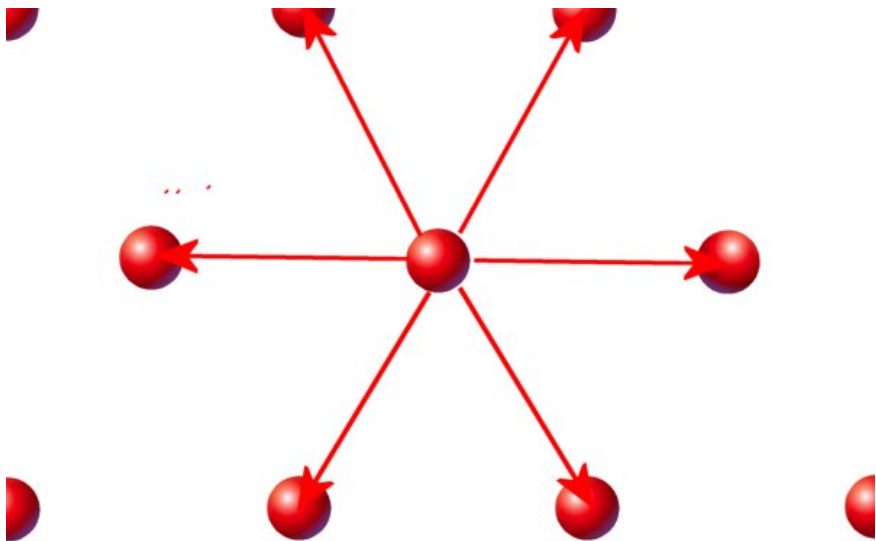

Each atom is now three-fold coordinated

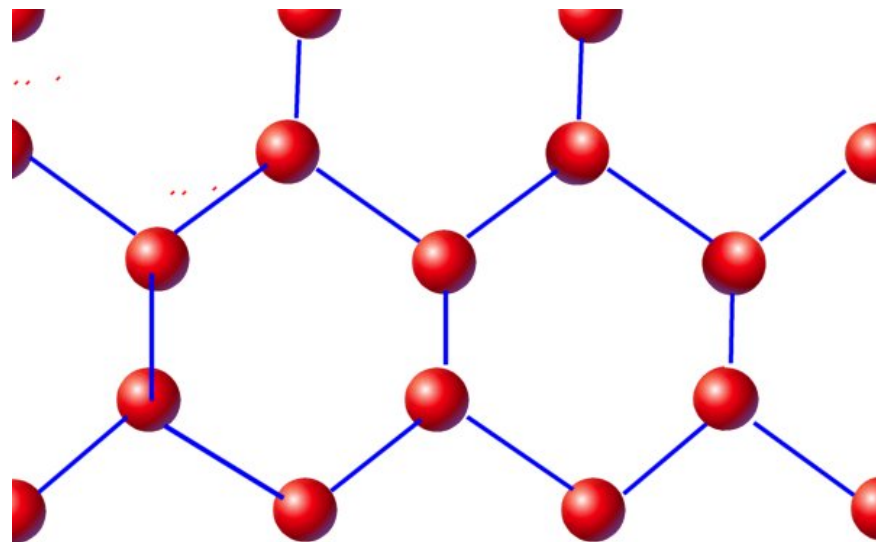

No atom forms bonds in quite that way. Add another atom in each cell (at  $\frac{1}{3}(a + b)$ ).

as in one of the planes of graphite. This is a *diatomic unit cell*.

### 1.7 Cubic crystals

#### 1.7.1 Sodium Chloride

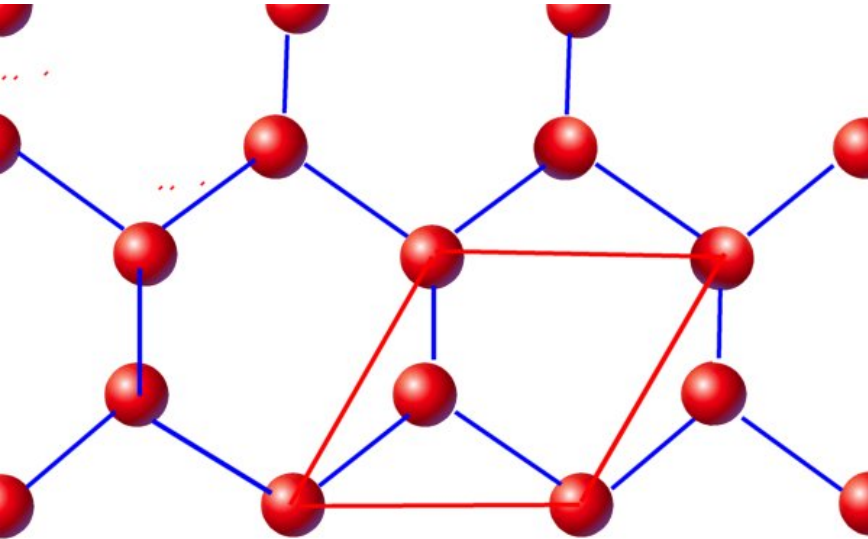
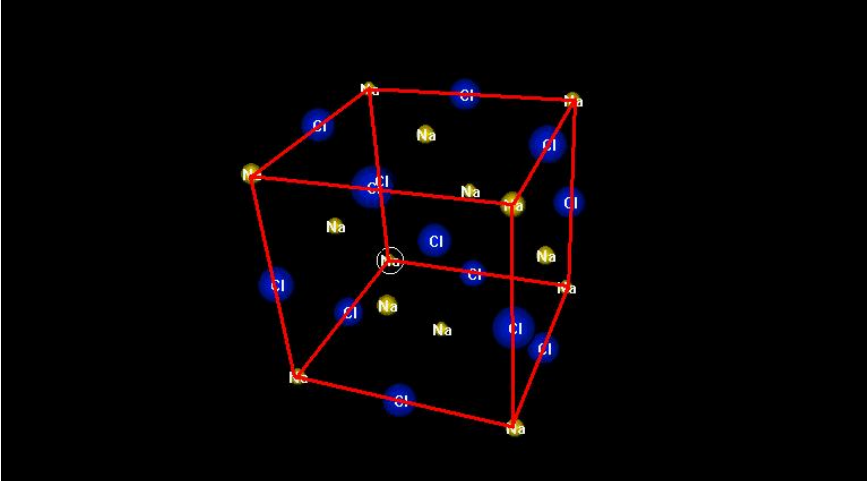
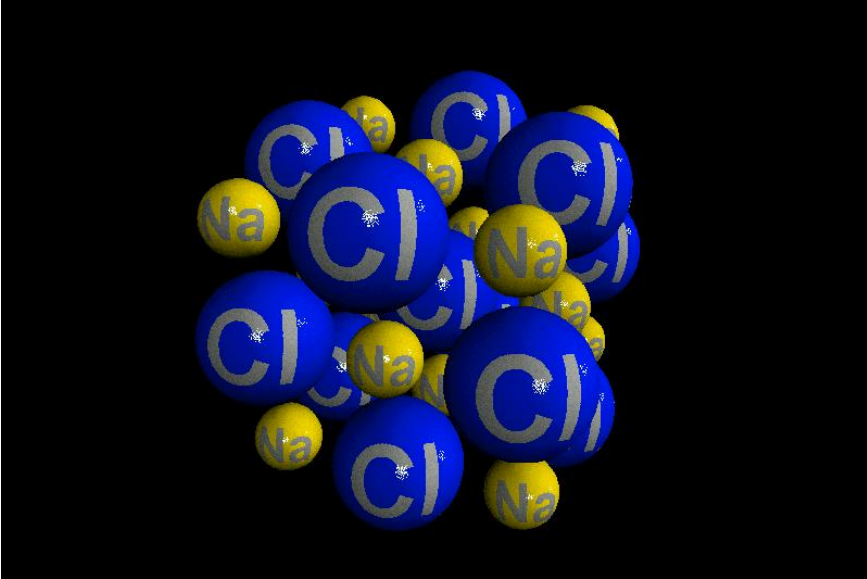

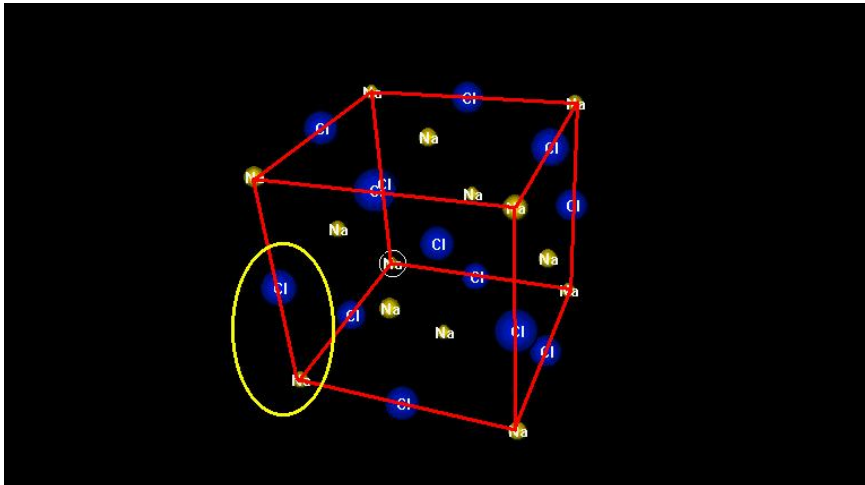

► focus on one atom in the repeat unit

► the lattice is revealed by the pattern of that atom

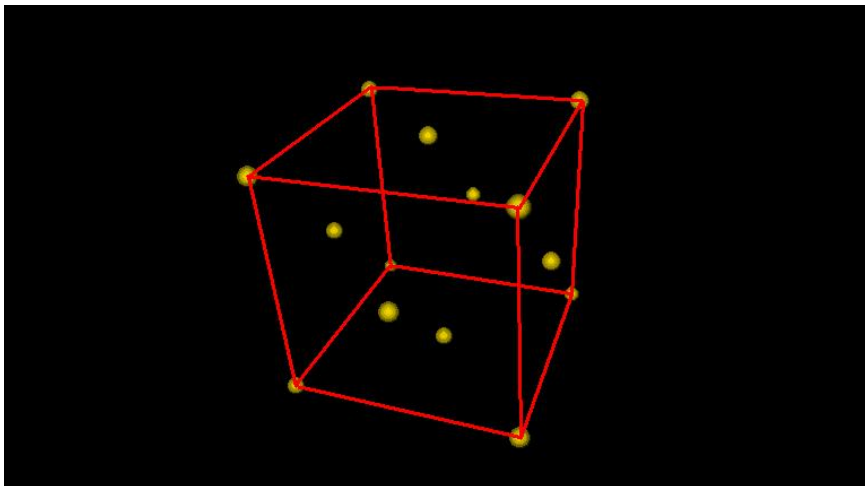

NaCl is a face-centred cubic structure. That is:

- look at the structure
- identify the repeat unit

### 1.7.2 Caesium Chloride

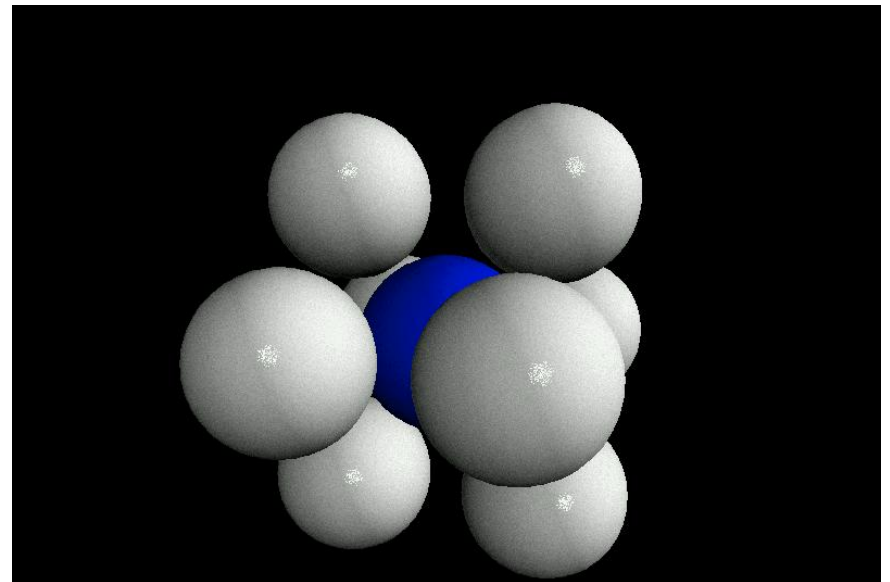

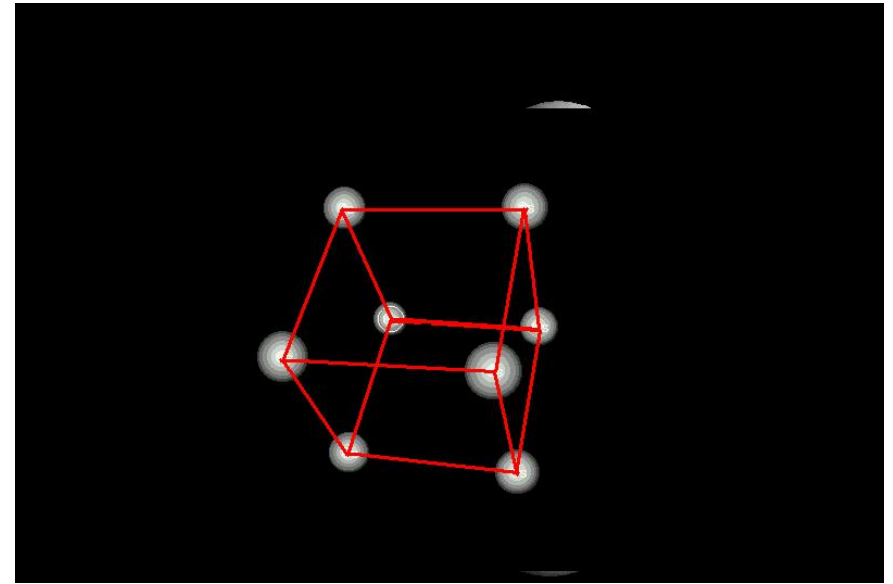
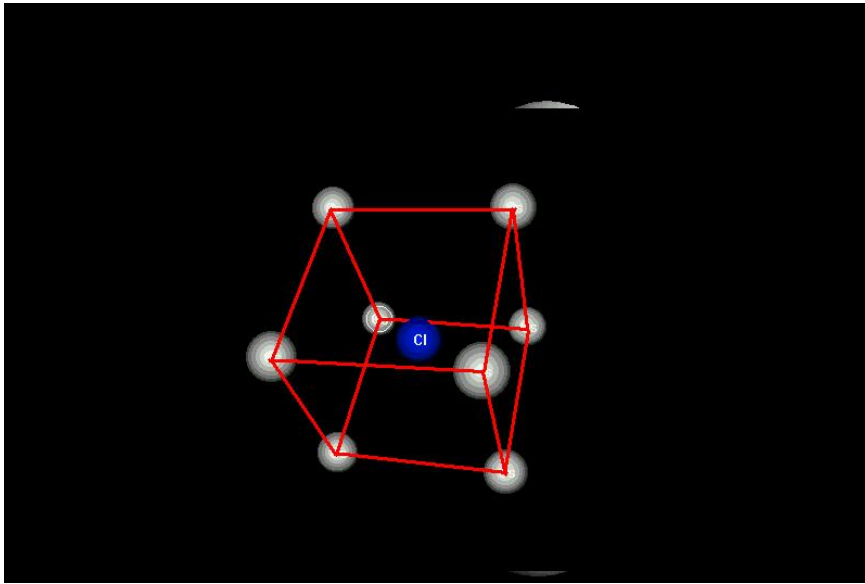

CsCl is a simple cubic structure.

## 1.8 Planes, Lines etc

### 1.8.1 Miller Indices

To index a plane

- ▶ find where the plane cuts the axes (at  $A, B, C$ )
- ▶ express the intercepts as  $u a, v b, w c$  ( $a, b, c$  are the lengths of the primitive lattice vectors)
- ▶ reduce the *reciprocals* of  $u, v$  and  $w$  to a set of integers  $h, k, l$  which have the same ratio

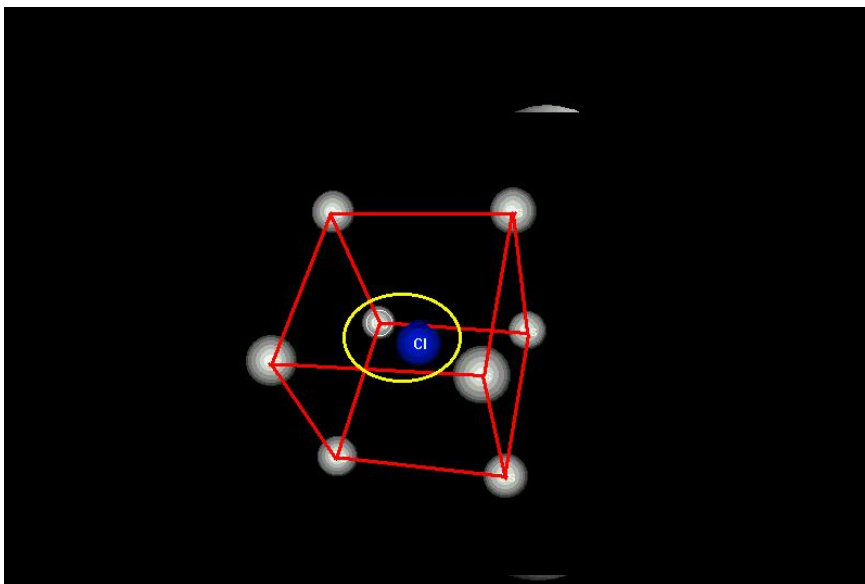

- ▶ the plane is then the  $(hkl)$  plane.
- ▶ conventionally, choose  $h$ ,  $k$  and  $l$  with common factors removed
- ▶ note if intercept is at infinity, corresponding index is 0.
- ▶ note convention: round brackets
- ▶ note convention: negative values are quoted with a bar over.

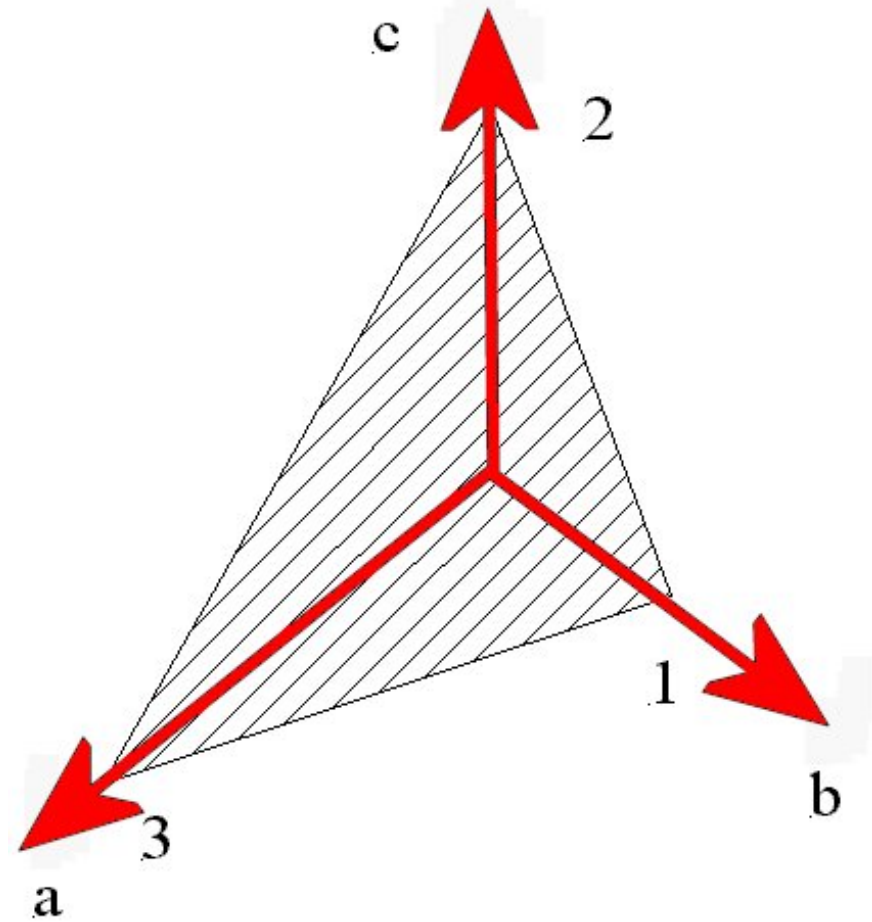

Intercepts:  $3a$ ,  $1b$ ,  $2c$   
Reciprocals  $1/3$ ,  $1$ ,  $1/2$   
Miller Indices  $(2,6,3)$

Example:



Families of planes:

- ▶ The indices  $(hkl)$  may refer to a single plane, or to a set of parallel planes.
- ▶ The  $(100)$  planes are a set of planes perpendicular to the  $x$ -axis, a distance  $a$  apart.
- ▶ The  $(200)$  planes are a set of planes perpendicular to the  $x$ -axis, a distance  $a/2$  apart.

**1.8.2 Directions**

Square bracket notation  $[hkl]$ . For cubic systems only,  $[hkl]$  direction is perpendicular to  $(hkl)$  plane.

**1.8.3 Symmetry-related sets**

Of directions:  $\langle hkl \rangle$  Of planes:  $\{hkl\}$ .

**1.8.4 Spacing between planes**

In a cubic system with lattice parameter (unit cell side)  $a$ , the  $(hkl)$  planes are separated by

$$d_{hkl} = \frac{a}{\sqrt{h^2 + k^2 + l^2}}.$$

Proof:

- ▶ We know (from first year Maths) that we can write the equation of a plane as

$$\hat{\mathbf{n}} \cdot \mathbf{r} = d$$

where  $\hat{\mathbf{n}}$  is a unit vector perpendicular to the plane and  $\mathbf{r}$  is the vector position of a point in the plane,  $\mathbf{r} = x\hat{\mathbf{x}} + y\hat{\mathbf{y}} + z\hat{\mathbf{z}}$ .

- ▶ Basically,  $\hat{\mathbf{n}}$  defines the orientation,  $d$  tells us how far the plane is from the origin: for a family of planes  $hkl$  there will be a plane through the origin too, and so  $d$  is the interplanar spacing.
- ▶ For the  $(hkl)$  planes in a lattice with lattice parameter  $a$ , we know that the intercepts of the planes on the axes are  $a/h$ ,  $a/k$  and  $a/l$ .
- ▶ So the equation of the plane is

$$hx + ky + lz = a. \tag{1.1}$$

- ▶ But the unit vector normal to the plane is

$$\hat{\mathbf{n}} = \frac{h\hat{\mathbf{x}} + k\hat{\mathbf{y}} + l\hat{\mathbf{z}}}{\sqrt{h^2 + k^2 + l^2}}$$

and thus

$$\hat{\mathbf{n}} \cdot \mathbf{r} = \frac{hx + ky + lz}{\sqrt{h^2 + k^2 + l^2}}$$

- ▶ whence, using equation 1.1,

$$d_{hkl} = \frac{a}{\sqrt{h^2 + k^2 + l^2}}.$$

Check: Consider the  $(110)$  planes: there is one through the origin, one diagonally across the middle of the cube, and so on. The perpendicular spacing is one half the diagonal of the cube face,  $\sqrt{2}/2 = 1/\sqrt{2} = 1/\sqrt{1^2 + 1^2 + 0^2}$ .

### 1.8.5 Angles between planes

For cubic crystals only. The unit vector normal to  $(hkl)$  is

$$\hat{\mathbf{n}} = \frac{h\hat{\mathbf{x}} + k\hat{\mathbf{y}} + l\hat{\mathbf{z}}}{\sqrt{h^2 + k^2 + l^2}}$$

and if we want to find the angle  $\theta$  between this plane and the plane  $(h'k'l')$  we use

$$\hat{\mathbf{n}} \cdot \hat{\mathbf{n}}' = \cos \theta$$

so

$$\cos \theta = \frac{hh' + kk' + ll'}{\sqrt{h'^2 + k'^2 + l'^2} \sqrt{h^2 + k^2 + l^2}}.$$

### 1.8.6 More Examples

Lattices with a non-monatomic basis.

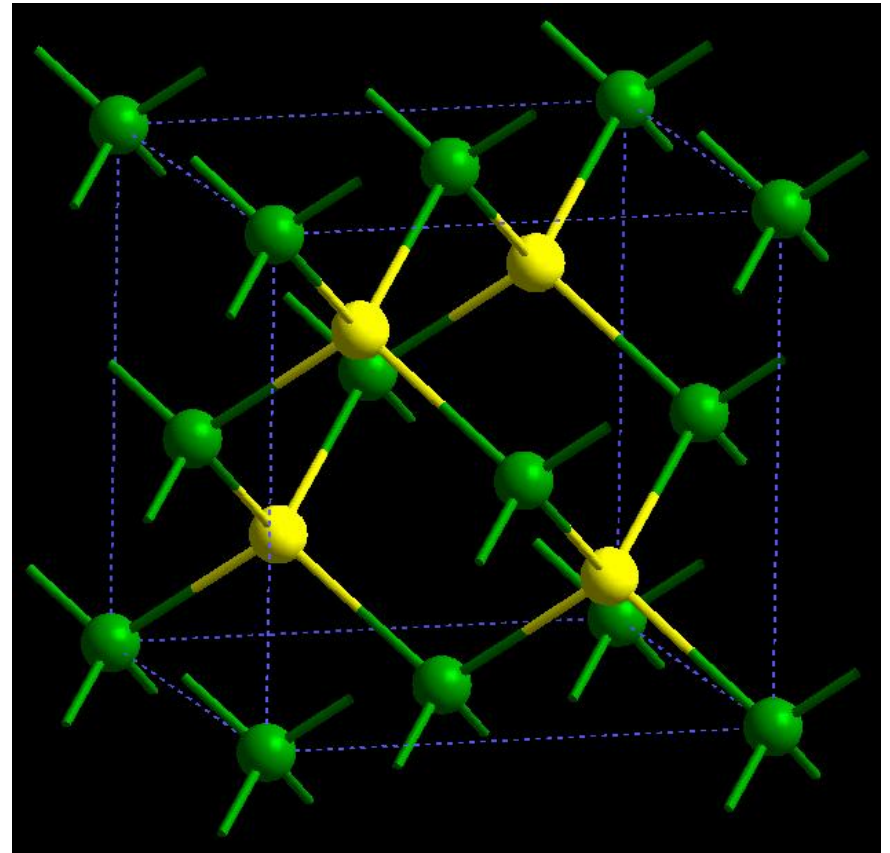

FCC, with basis of Ga at  $(000)$ , As at  $(\frac{1}{4}, \frac{1}{4}, \frac{1}{4})$ .

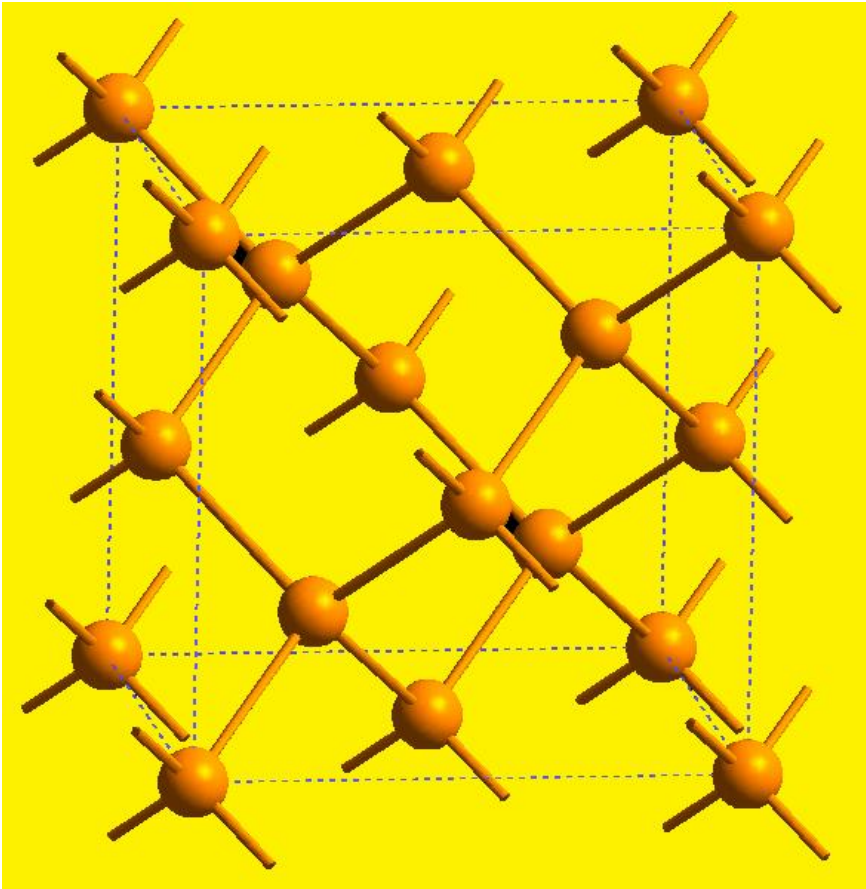

Diamond or Silicon: FCC, with basis of Si at  $(000)$ , Si at  $(\frac{1}{4}, \frac{1}{4}, \frac{1}{4})$  – inequivalent atoms (look at bonding).

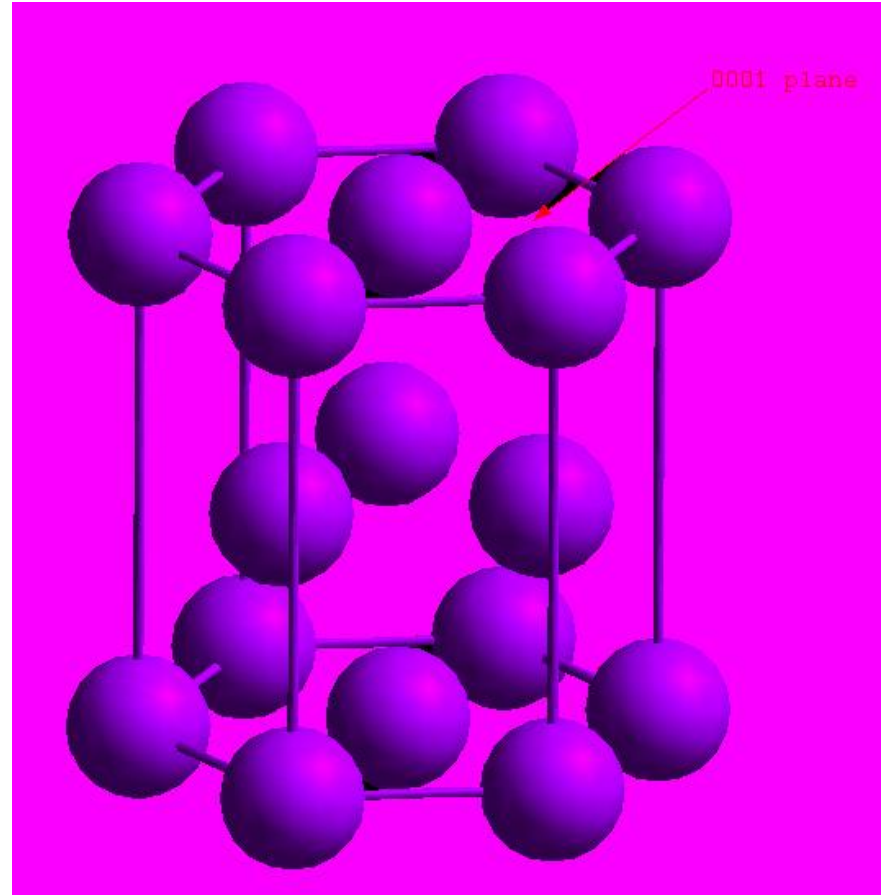

Hexagonal close packing: basis of one atom at  $(0,0,0)$  and one at  $\frac{1}{3}(\mathbf{a} + \mathbf{b}) + \frac{1}{2}\mathbf{c}$ . For perfect packing,  $c = \sqrt{8/3}a$ .

Hexagonal close packing and face-centred cubic (cubic close-packing) are similar – in each case we stack up planes of closely-packed atoms, but the sequence is different. In cubic, the close-packed planes are  $(111)$ .

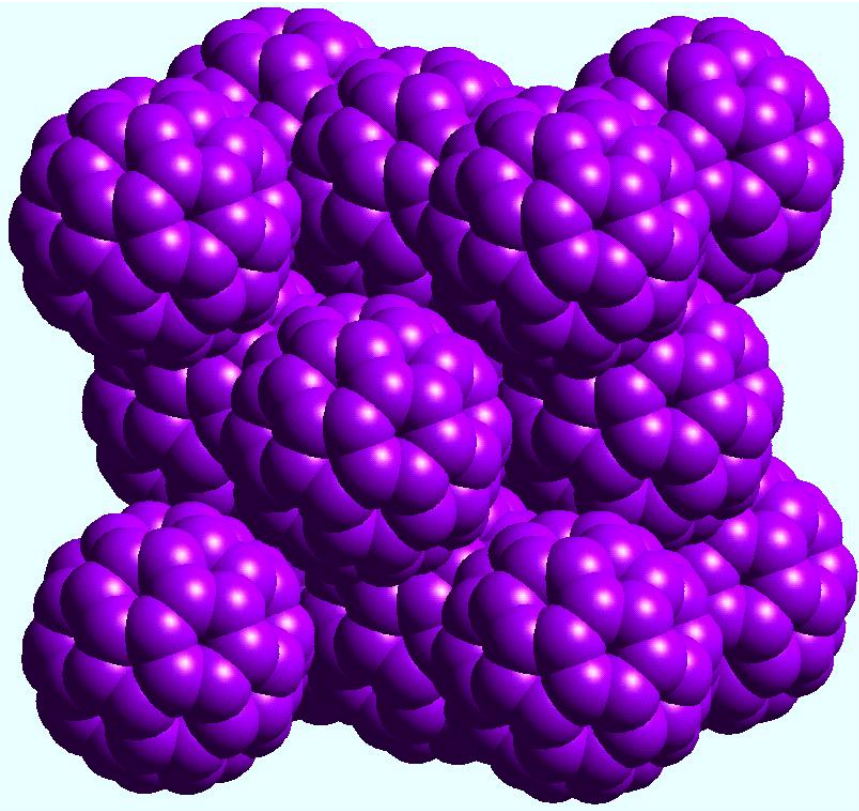

Buckminsterfullerene: FCC, with basis of one  $C_{60}$  molecule at (000) – really orientations of molecules will differ.

## 1.9 Packing Fractions

For monatomic cubic crystals, it is easy to work out the *packing fraction*, that is, the fraction of space that is filled if we place a sphere on each lattice site and expand the spheres until they touch.

### 1.9.1 Simple cubic

The spheres touch along the  $[100]$  directions, so if the lattice parameter is  $a$  the sphere radius is  $a/2$  so the packing fraction is

$$\frac{\text{sphere volume}}{\text{cell volume}} = \frac{\frac{4}{3}\pi(a/2)^3}{a^3} = 0.52$$

### 1.9.2 Body-centred cubic

The spheres touch along the  $[111]$  directions, so if the lattice parameter is  $a$  the sphere radius is  $a\sqrt{3}/4$  so the packing fraction is

$$\frac{\text{twice sphere volume}}{\text{cell volume}} = 2\frac{\frac{4}{3}\pi(a\sqrt{3}/4)^3}{a^3} = 0.68$$

### 1.9.3 Face-centred cubic

The spheres touch along  $(110)$  directions, so if the lattice constant is  $a$ , then the sphere radius is  $a/2\sqrt{2}$

$$\frac{\text{four times sphere volume}}{\text{cell volume}} = 4\frac{\frac{4}{3}\pi(a/2\sqrt{2})^3}{a^3} = 0.74$$

### 1.9.4 Hexagonal close-packed

Packing fraction is 0.74.

## 1.10 Defects

Nothing in Nature is perfect, and crystals are no exception. Any real crystal contains defects, and these affect its properties in various ways.

- ▶ Defects in diamond alter the colour;
- ▶ defects in semiconductors (of the right kind) allow them to be used to make devices;
- ▶ defects in metals alter their mechanical properties;
- ▶ defects affect thermal and electrical conductivity.

### 1.10.1 Point defects

- ▶ Missing atoms, atoms in positions where an atom would not normally be (interstitials), impurities.
- ▶ Schottky defect: an atom is transferred from a site in the crystal to a site on the surface. If this costs energy  $E_v$ , the number of vacancies in equilibrium is

$$n = N \exp(-E_v/k_B T),$$

where  $N$  is the total number of atoms in the crystal (see 2B28 notes).

- ▶ Remember that crystals are often formed by cooling quite quickly from the melt, and atoms move quite slowly in solids, so a high-temperature number of defects can be 'frozen in'.

- ▶ In ionic crystals, to keep the crystal neutral we form positive and negative defects in charge-compensating pairs.
- ▶ Frenkel defect: an atom is moved from a normal atomic position to an interstitial position. Solid-state diffusion is affected by defects.

### 1.10.2 Dislocations

Dislocations are *line defects*. Simplest to visualize is an *edge dislocation* – think of an extra half-plane of atoms.

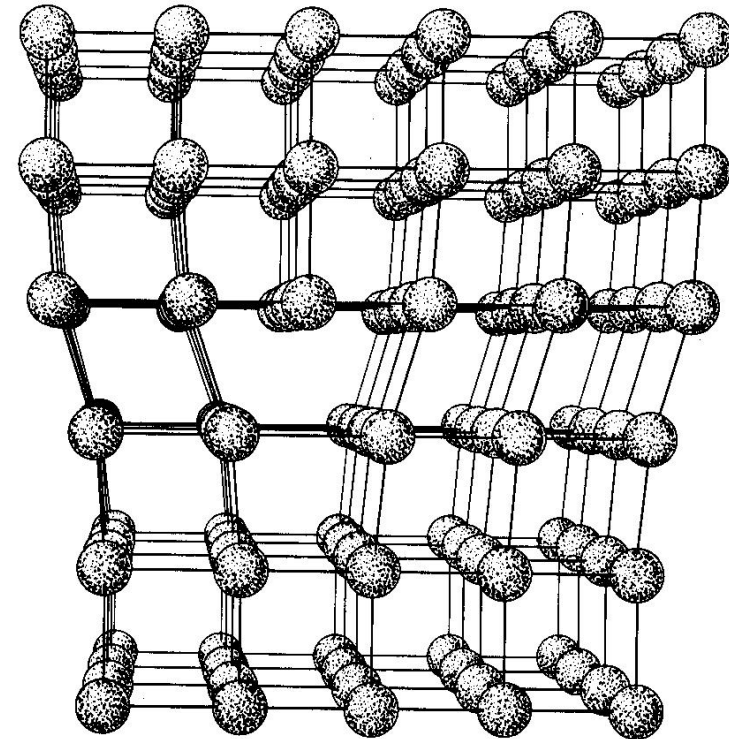

Affects deformation properties – to slide upper block over lower now only requires a *line* of bonds to break at a time, not a whole *plane* – process of *slip*. Explains low yield strength of solids. Screw dislocations give a helical structure to the planes.

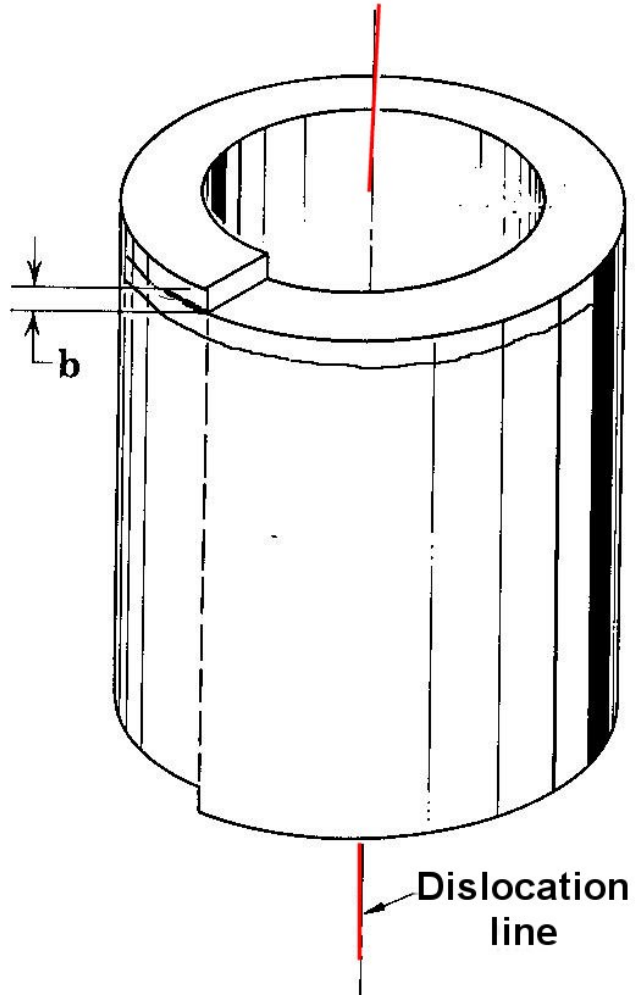

Screw dislocations often show up in crystal growth



A growth spiral on a silicon carbide crystal, originating from the point of emergence of a screw dislocation (courtesy Prof. S. Amelinckx).

Dislocations are characterised by their *Burgers vectors* – the mismatch in position between going round a path in the perfect crystal or round the dislocation.

Edge:  $b$  perpendicular to line of dislocation. Screw:  $b$  parallel to line of dislocation.

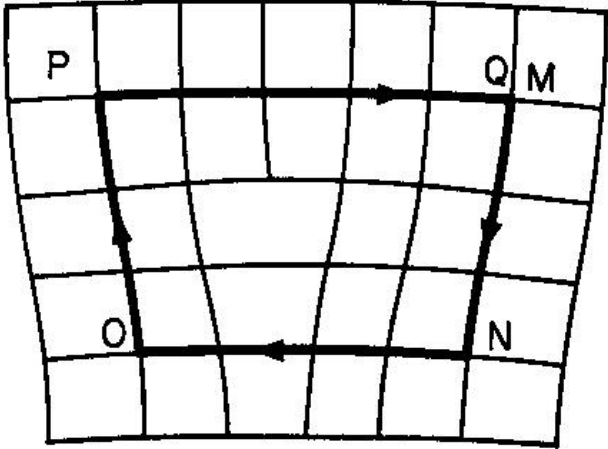

**1.10.3 Planar defects**

In a sense, the surface of a crystal is a planar defect! If two crystals grow together with a mismatch in orientation, we have a *grain boundary*.

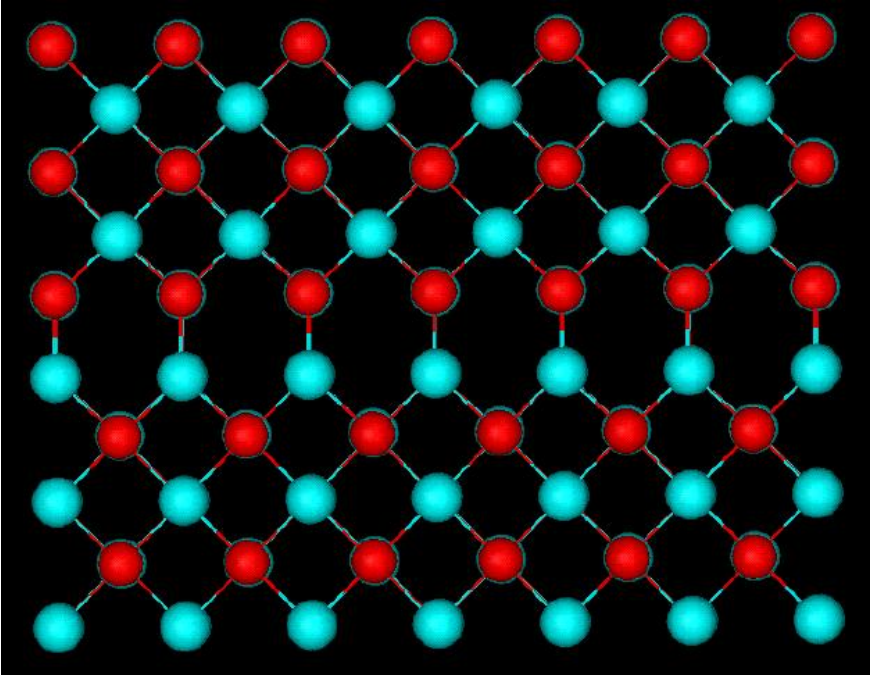
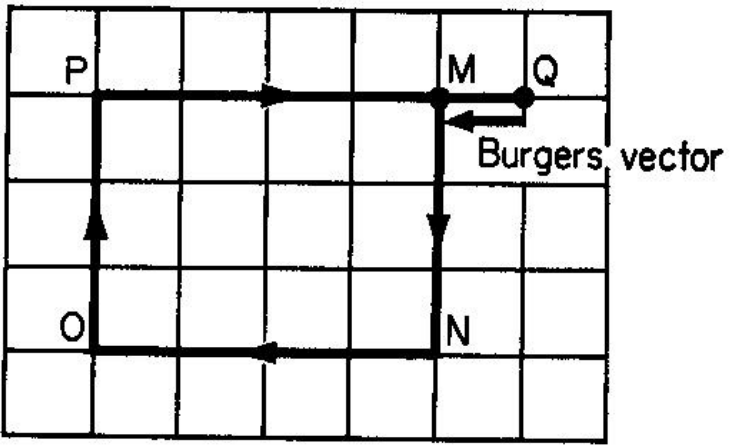

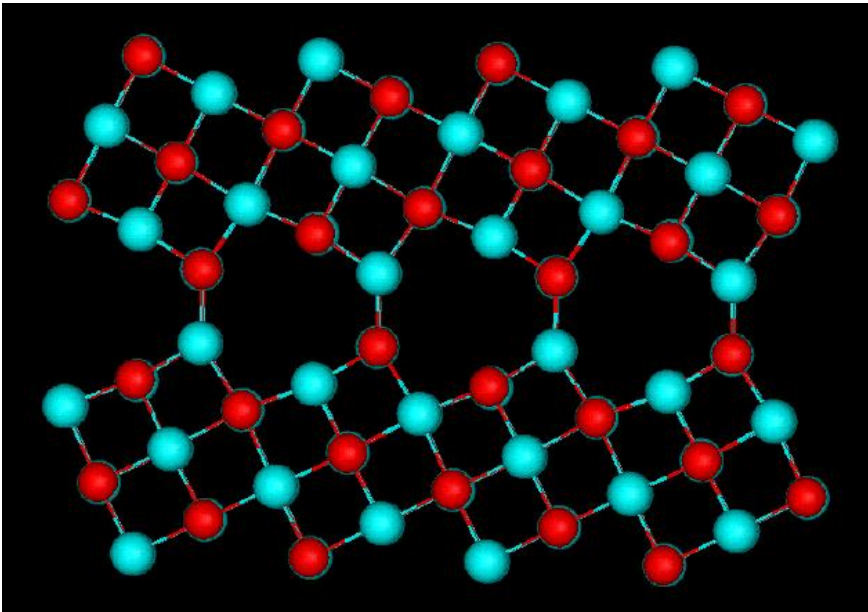

Can sometimes represent a grain boundary as a line of edge dislocations.

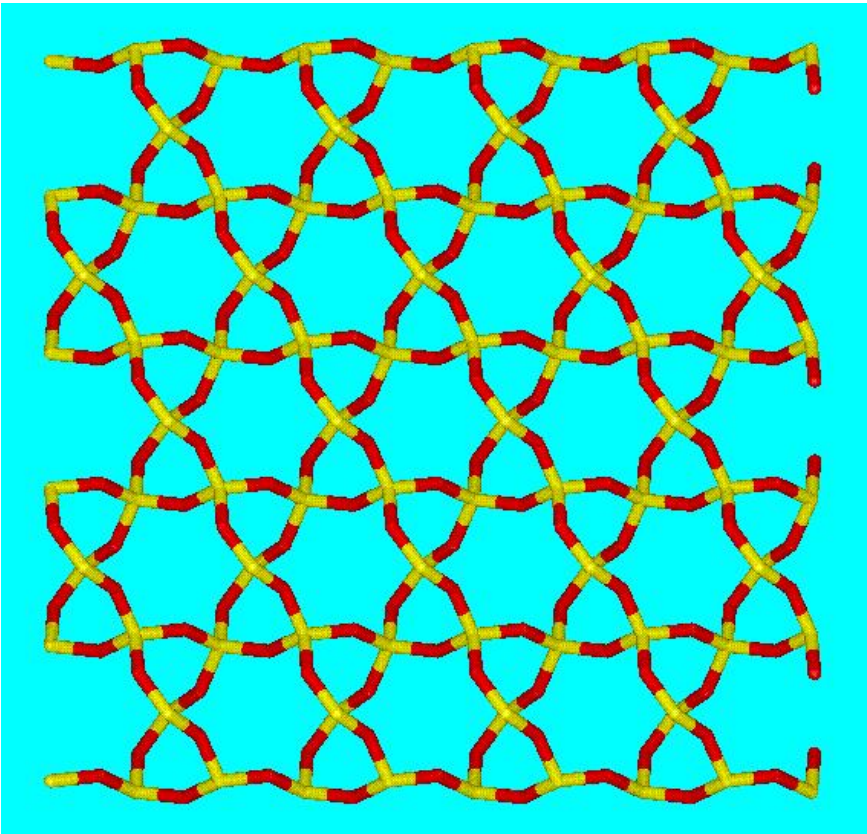

### 1.10.4 Amorphous Solids

Not all solids are crystalline: if a crystalline material is represented by:

then an amorphous structure would be



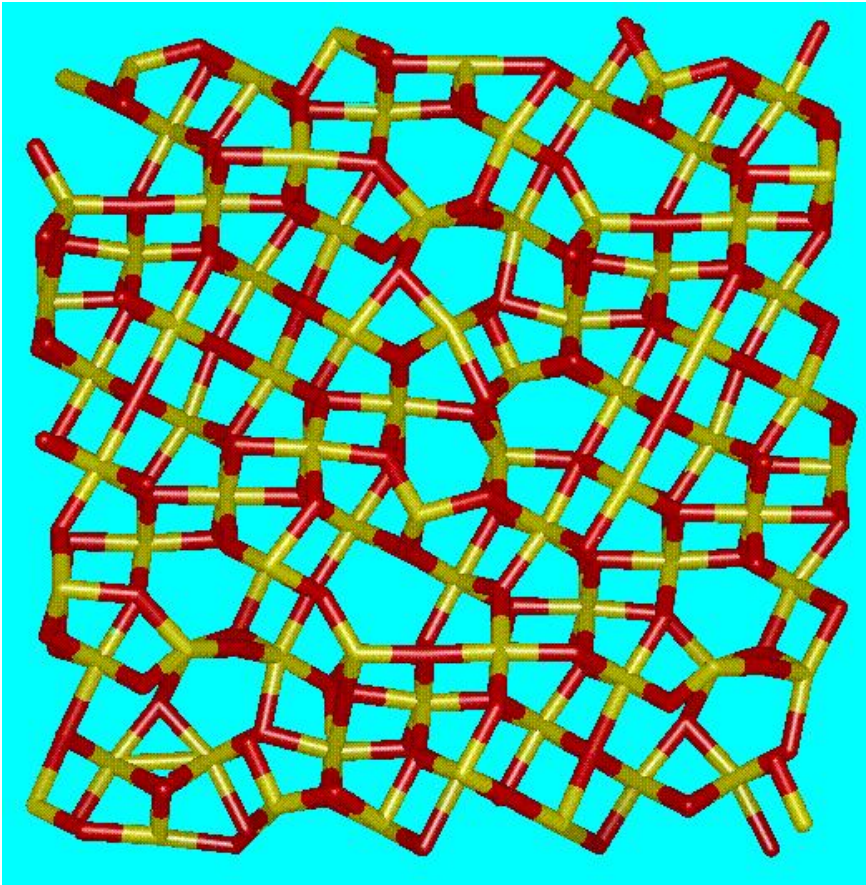

The *local* structure is similar to that in the crystal, but *long-range order* is lost.

# Chapter 2

# Crystal Diffraction

## 2.1 Preliminaries

### 2.1.1 Required Knowledge

- ▶ Wave motion
- ▶ Complex exponentials

### 2.1.2 Reading

- ▶ Hook and Hall 1.4, 11.2, 12.2, 12.3, 12.6

## 2.2 Bragg's Law

*Any plane of regularly spaced atoms will act as a mirror:*

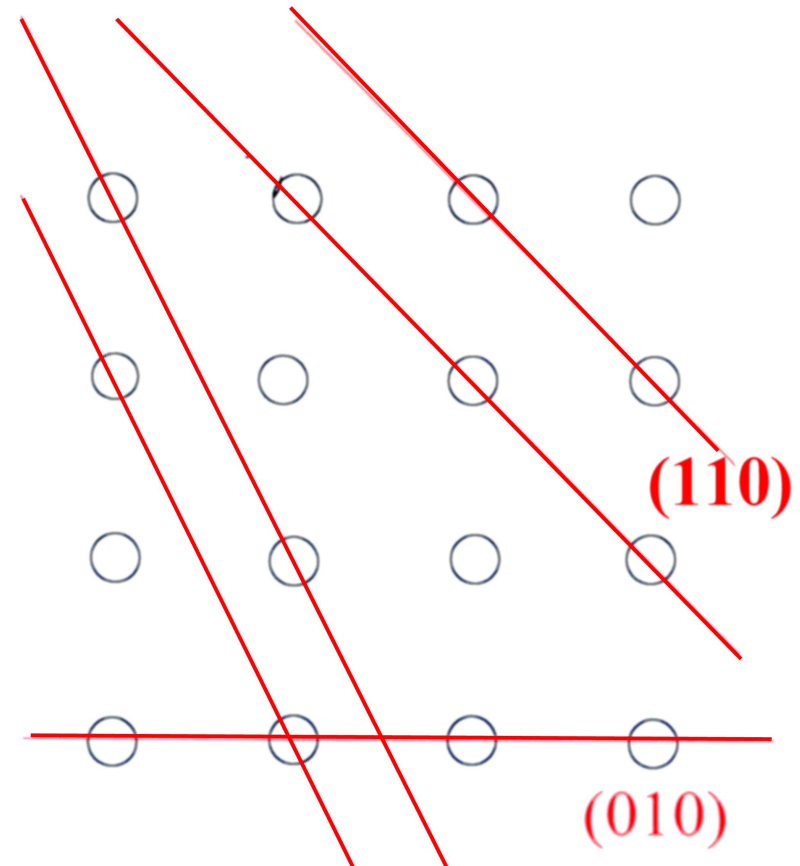

The reflectivity will depend on the number of atoms per unit area in the plane.

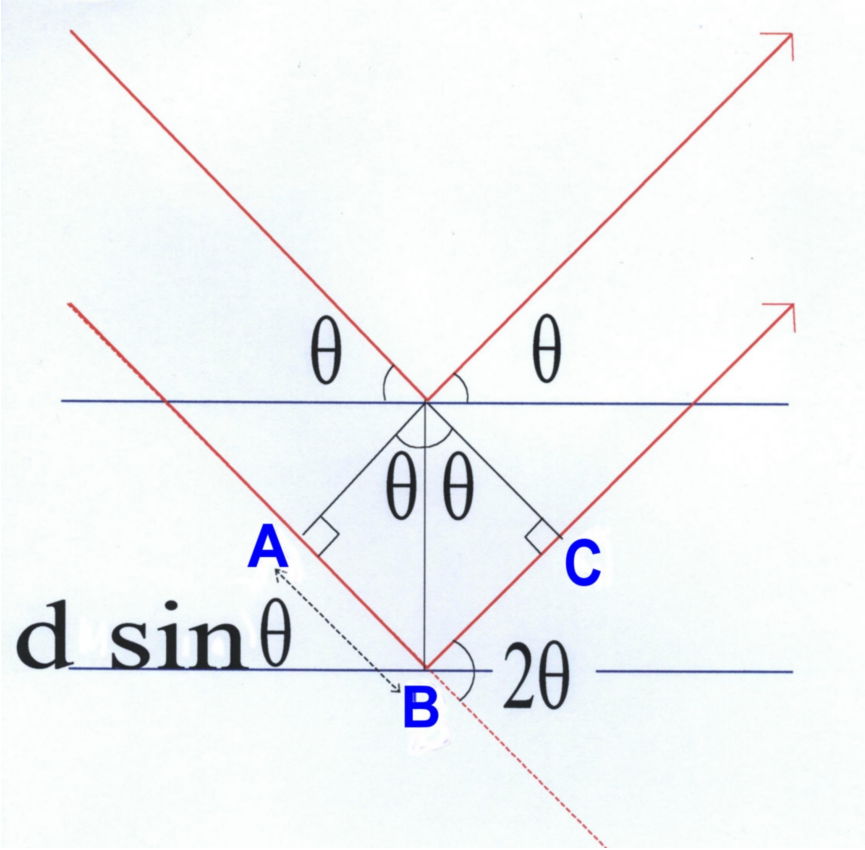
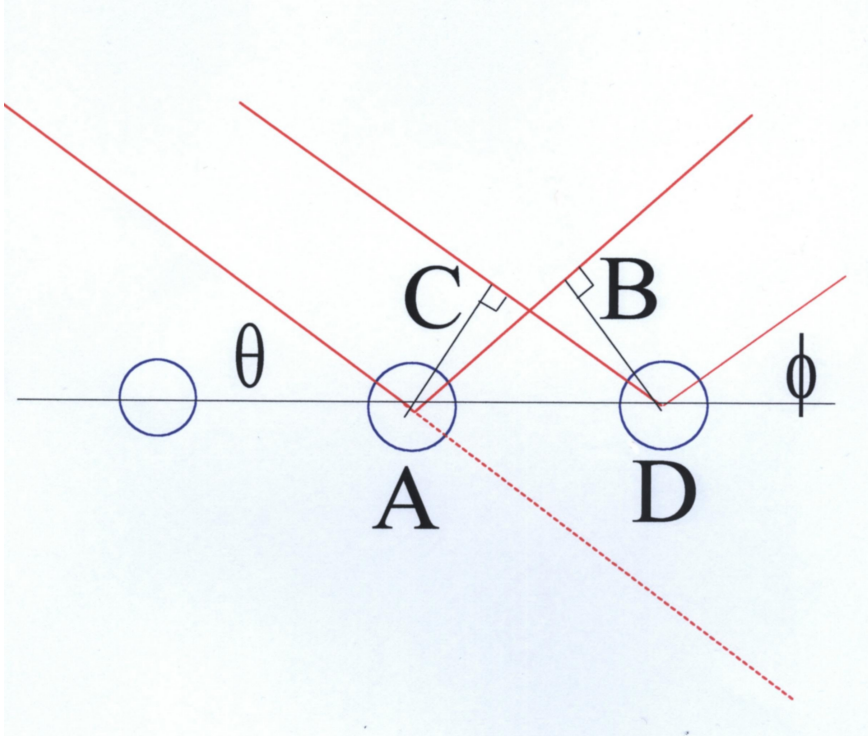

- ▶ The extra path travelled by the left-hand ray on the way out ( $AB$ ) must equal the extra path travelled by the right-hand ray on the way in ( $CD$ )
- ▶ Thus  $\theta = \phi$ , producing a reflection
- ▶ This corresponds to zeroth order from diffraction grating
- ▶ Now consider interference between reflections from successive planes

- ▶ Constructive interference if the extra path  $ABC = n\lambda$ , or  $2d \sin \theta = n\lambda$ ,
- ▶ This is *Bragg's law*.
- ▶ NOTE: the angle is between the ray and the plane – not the same convention as in optics
- ▶ If the Bragg angle is  $\theta$ , the beam is deflected through  $2\theta$ .

Notation:

- ▶ We refer to  $(hkl)$  reflections, according to the plane which is reflecting.
- ▶ The  $n$  in  $2d \sin \theta = n\lambda$  is called the *order* of the reflection or of the diffraction.
- ▶ The terms “ $n$ th order  $(hkl)$  reflection” and “ $(nh \ nk \ nl)$  reflection” are equivalent.

### 2.3 Wavelengths and Energies

- ▶ From Bragg’s law ( $2d \sin \theta = n\lambda$ ) we must have  $\lambda \leq 2d$ , that is  $\lambda \approx 1$  or  $0.1$  nm.
- ▶ We can use x-rays, neutrons (or electrons – but mainly for surfaces).
- ▶  $\lambda = h/p$  ( $h$  is Planck’s constant)
  - ▷ For electrons and neutrons  $E = p^2/2m$
  - ▷ For x-rays  $E = pc$

Beam	Scattered from	Energy for $\lambda = 1$	General ( $\lambda$ in Å and $E$ in eV)
x-ray	electrons	12 keV	$\lambda = \frac{12399}{E}$
neutron	nuclei	0.08 eV	$\lambda = \frac{0.2862}{\sqrt{E}}$
electron	electrons	150 eV	$\lambda = \frac{12.264}{\sqrt{E}}$

### 2.3.1 X-ray sources

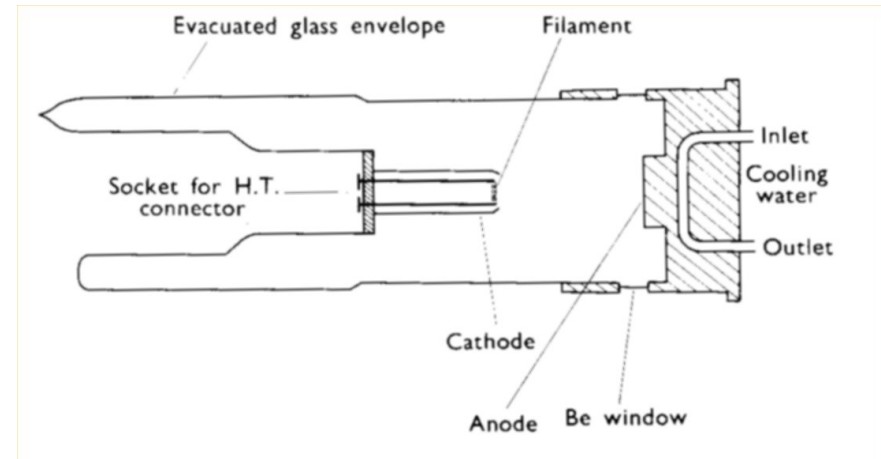

Kilovolt electrons impinge on target.

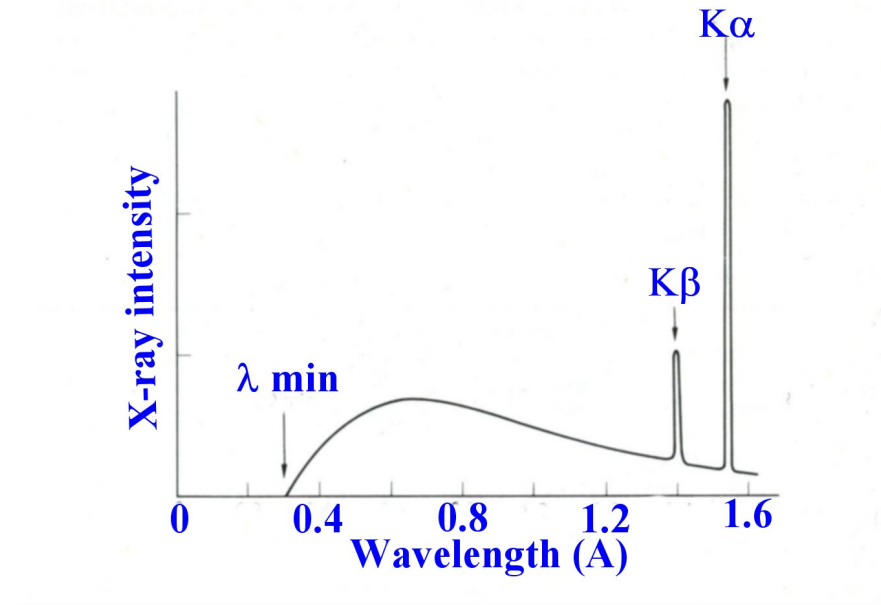

- ▶ Continuum background from deflection of electrons.
- ▶ Sharp lines from intra-atomic transitions.

**2.3.2 Electron sources**

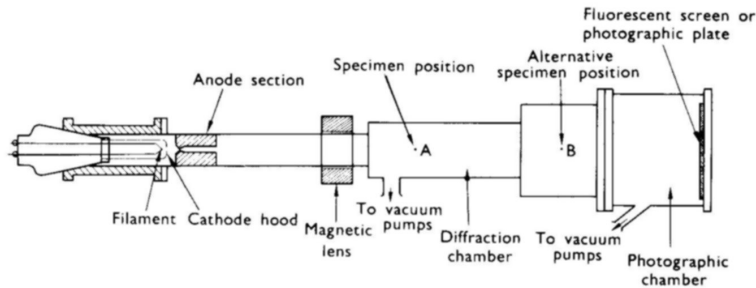

Schematic diagram of an electron diffraction apparatus.

- ▶ Hot cathode – electrons accelerated by electric field, focussed with magnetic field.
- ▶ Low penetration – study thin films or surfaces.

**2.3.3 Neutron sources**

Reactor:

- ▶ Thermal neutrons (energy about  $k_B T$ ) – need moderator to slow neutrons
- ▶ Boltzmann velocity distribution
- ▶ Collimate beam

Use broad range of wavelengths, or put through monochromator

- ▶ Mechanical chopper – time taken to traverse known distance gives velocity
- ▶ Bragg’s law ‘in reverse’ – use crystal of known plane spacing, so know wavelength if know  $\theta$

Spallation source:

- ▶ Accelerate protons (800MeV) and fire at heavy nuclei (e.g. uranium)
- ▶ Neutrons thrown off
- ▶ Intense, usually pulsed ( $10\mu s$ ), source.

**2.4 Elastic Scattering**

Energy of waves is conserved , thus the exit wavelength is equal to the incident wavelength.

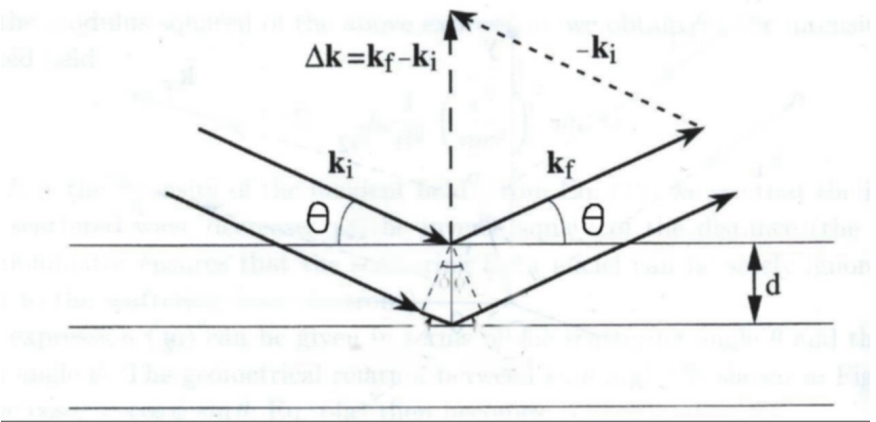

$$\lambda_i = \lambda_f,$$

so

$$|\mathbf{k}_i| = |\mathbf{k}_f|.$$

$$|\Delta k| = 2|\mathbf{k}_i| \sin \theta = 2 \frac{2\pi}{\lambda} \sin \theta = n \frac{2\pi}{d},$$

from Bragg's law.

Special relationship between  $\Delta k$  and the planes:

- ▶  $\Delta k$  is perpendicular to the scattering planes,
- ▶ length of  $\Delta k$  is integer multiple of  $2\pi$  divided by the plane spacing.

### 2.4.1 Example

- ▶ X-ray scattering from  $\text{NaClO}_3$ . Cu  $K_\alpha$  radiation,  $\lambda = 1.54$  .

$\theta^\circ$	$\sin \theta$	$\sin^2 \theta$	$N$	$(hkl)$	$a$
9.544	0.1658	0.0275	2	(110)	6.568
11.720	0.2031	0.0413	3	(111)	6.567
13.561	0.2345	0.0550	4	(200)	6.567
15.201	0.2622	0.0688	5	(210)	6.567
16.701	0.2874	0.0826	6	(211)	6.563
19.374	0.3317	0.1100	8	(220)	6.566
20.597	0.3518	0.1238	9	(221)(300)	6.566
21.771	0.3709	0.1376	10	(310)	6.565

- ▶ If we vary the reflection plane, but work at fixed order ( $n$ )

$$d_{hkl} = \frac{a}{\sqrt{h^2 + k^2 + l^2}} = \frac{n\lambda}{2 \sin \theta}$$

$$\Rightarrow \left( \frac{\sin \theta}{\sin \theta_{min}} \right)^2 = h^2 + k^2 + l^2 = N$$

## 2.5 Experimental Methods

Notes:

- ▶ Examples show photographic film, for x-rays.
- ▶ Can also use electronic detection for x-rays.
- ▶ Need counters (e.g.  $\text{BF}_3$ ) for neutrons.
- ▶ Information:
  - ▷ Positions of lines (geometry)
  - ▷ Intensities of lines (electronics, or photogrammetry to measure darkness of lines on films)

### 2.5.1 Laue Method

- ▶ 1912: Max von Laue (assisted by Paul Knipping and Walter Friedrich).  $\text{CuSO}_4$  and  $\text{ZnS}$ .
- ▶ Uses a broad x-ray spectrum and a single crystal

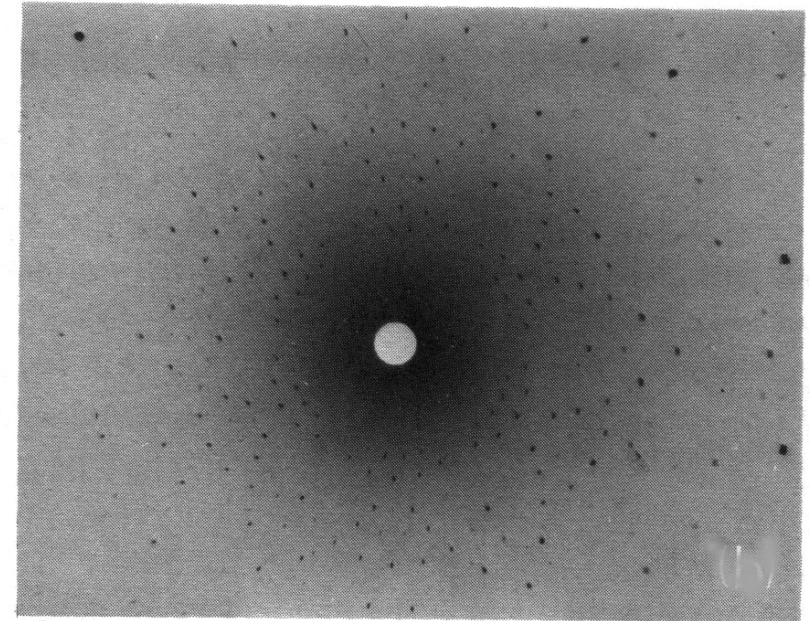
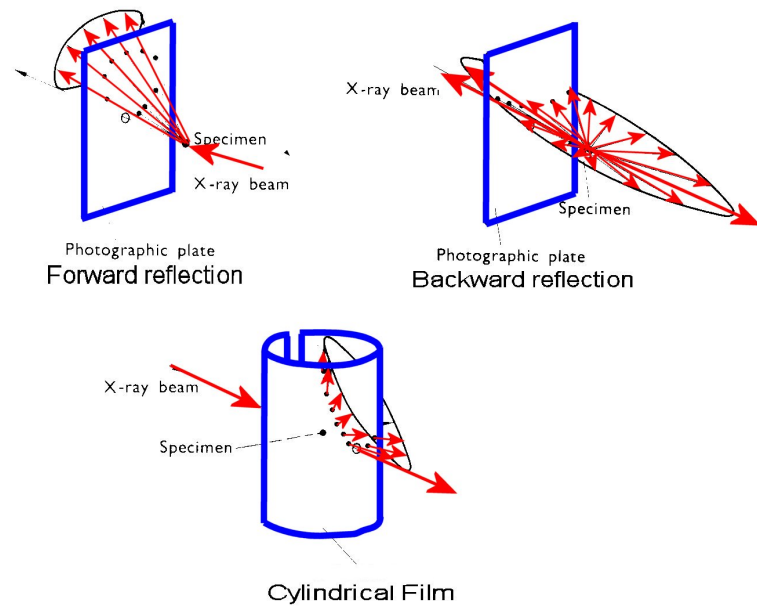

- ▶ Forward scattering Laue image of hexagonal crystal.
- ▶ Shows crystal symmetry, when the crystal is appropriately oriented.
- ▶ Used for aligning crystal for other methods.
- ▶ Because a range of  $\lambda$  is used, it cannot be used to determine  $a$  from photographic image
- ▶ However, if the outgoing wavelengths can be measured, then it can be used to find lattice parameters.

### 2.5.2 Rotating Crystal Method

- ▶ Uses a single x-ray wavelength and a single crystal is rotated in the beam.
- ▶ Either full 360° rotation (as below) or small (5 to 15°) oscillations.

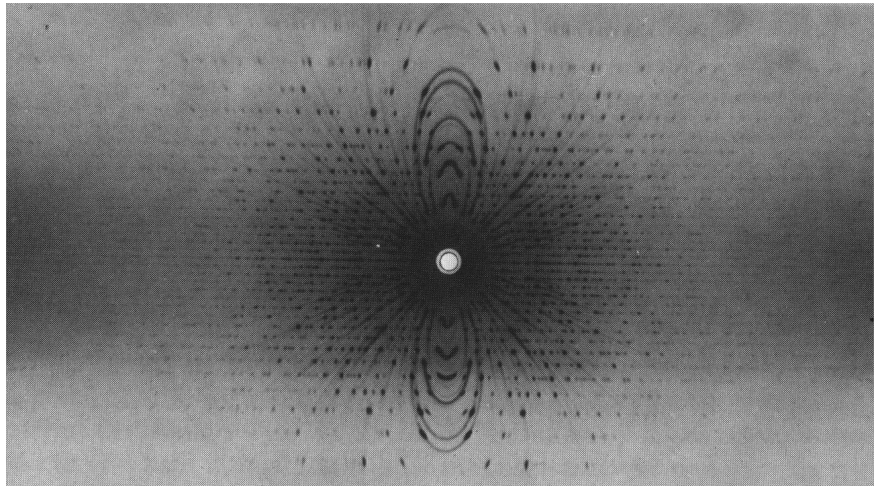

### 2.5.3 Powder Methods

- ▶ Uses a single x-ray wavelength and finely powdered sample.
- ▶ Effect is similar to rotating crystal, but rotated about all possible axes.

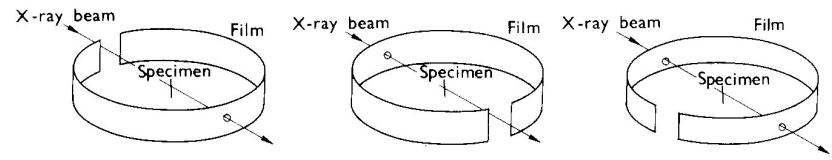

X-ray powder diffraction pattern of NaClO<sub>3</sub> taken with CuK $\alpha$  radiation.



X-ray powder diffraction pattern of SiO<sub>2</sub> taken with CuK $\alpha$  radiation.

- ▶ Powder diffraction patterns are often used for identifying materials.

## 2.6 Mathematics of Diffraction

### 2.6.1 Monatomic Structure

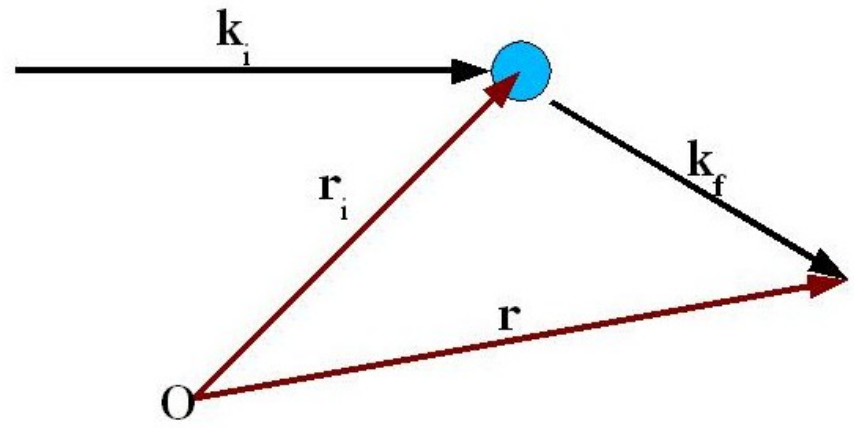



- ▶ Incoming plane wave

$$\psi_i = A \exp[i(\mathbf{k}_i \cdot \mathbf{r} - \omega t)]$$

- ▶ Scattered by the atom in unit cell  $I$  at  $\mathbf{r}_I$ .
- ▶ Assume scattered amplitude is  $S A$  – all the unit cells are the same, so independent of  $I$ .
- ▶ When incident wave hits atom, it is

$$A \exp[i(\mathbf{k}_i \cdot \mathbf{r}_I - \omega t)].$$

- ▶ It is scattered with a different wave-vector,  $\mathbf{k}_f$ , so from the atom to a point  $\mathbf{r}$  its phase changes by  $\mathbf{k}_f \cdot (\mathbf{r} - \mathbf{r}_I)$ .
- ▶ The scattered wave is thus

$$S A \exp[i(\mathbf{k}_i \cdot \mathbf{r}_I - \omega t)] \exp[i\mathbf{k}_f \cdot (\mathbf{r} - \mathbf{r}_I)]$$

- ▶ or

$$S A \exp[i(\mathbf{k}_f \cdot \mathbf{r} - \omega t)] \exp[i(\mathbf{k}_i - \mathbf{k}_f) \cdot \mathbf{r}_I].$$

- ▶ So if a plane wave with wavevector  $\mathbf{k}_f$  is scattered from the crystal, it is the sum of the waves scattered by all the atoms, or

$$\text{Total Wave} = S A \exp[i(\mathbf{k}_f \cdot \mathbf{r} - \omega t)] \sum_I \exp[i(\mathbf{k}_i - \mathbf{k}_f) \cdot \mathbf{r}_I].$$

- ▶ Write  $\Delta \mathbf{k} = \mathbf{k}_f - \mathbf{k}_i$ , hence

$$\text{Total Wave} = S A \exp[i(\mathbf{k}_f \cdot \mathbf{r} - \omega t)] \sum_I \exp[-i\Delta \mathbf{k} \cdot \mathbf{r}_I],$$

- ▶ and as the amplitude of the outgoing wave  $\exp[i(\mathbf{k}_f \cdot \mathbf{r} - \omega t)]$  is 1,

$$\text{Total Amplitude} \propto S \sum_I \exp[-i\Delta \mathbf{k} \cdot \mathbf{r}_I].$$

### 2.6.2 The Reciprocal Lattice

- ▶ Define a new set of vectors ( $\mathbf{A}, \mathbf{B}, \mathbf{C}$ ) with which to define  $\Delta \mathbf{k}$ . Require

$$\begin{aligned} \mathbf{a} \cdot \mathbf{A} &= 2\pi, & \mathbf{a} \cdot \mathbf{B} &= 0, & \mathbf{a} \cdot \mathbf{C} &= 0 \\ \mathbf{b} \cdot \mathbf{A} &= 0, & \mathbf{b} \cdot \mathbf{B} &= 2\pi, & \mathbf{b} \cdot \mathbf{C} &= 0 \\ \mathbf{c} \cdot \mathbf{A} &= 0, & \mathbf{c} \cdot \mathbf{B} &= 0, & \mathbf{c} \cdot \mathbf{C} &= 2\pi \end{aligned}$$

- ▶ In general,

$$\begin{aligned} \mathbf{A} &= \frac{2\pi \mathbf{b} \times \mathbf{c}}{\mathbf{a} \cdot \mathbf{b} \times \mathbf{c}} \\ \mathbf{B} &= \frac{2\pi \mathbf{c} \times \mathbf{a}}{\mathbf{a} \cdot \mathbf{b} \times \mathbf{c}} \\ \mathbf{C} &= \frac{2\pi \mathbf{a} \times \mathbf{b}}{\mathbf{a} \cdot \mathbf{b} \times \mathbf{c}} \end{aligned}$$

- ▶ The vectors ( $\mathbf{A}, \mathbf{B}, \mathbf{C}$ ) define the *reciprocal lattice*.
- ▶ For simple cubic system, reciprocal lattice vectors are just  $2\pi/a$  along the  $x, y$  and  $z$  axes.

Lattice	Reciprocal Lattice
Simple cubic	Simple cubic
FCC	BCC
BCC	FCC
Hexagonal	Hexagonal

### 2.6.3 The Scattered Amplitude

► Let

$$\Delta\mathbf{k} = h\mathbf{A} + k\mathbf{B} + l\mathbf{C},$$

► and remember that our structure is periodic:

$$\mathbf{r}_I = n_1\mathbf{a} + n_2\mathbf{b} + n_3\mathbf{c}.$$

► Immediately we have (because  $\mathbf{A}\cdot\mathbf{a} = 2\pi$  etc.)

$$\Delta\mathbf{k}\cdot\mathbf{r}_I = 2\pi(hn_1 + kn_2 + ln_3).$$

► So

$$\begin{aligned} \sum_I \exp[-i\Delta\mathbf{k}\cdot\mathbf{r}_I] &= \sum_{n_1} \sum_{n_2} \sum_{n_3} \exp[-2\pi i(hn_1 + kn_2 + ln_3)] \\ &= \left\{ \sum_{n_1} e^{-2\pi i h n_1} \right\} \left\{ \sum_{n_2} e^{-2\pi i k n_2} \right\} \left\{ \sum_{n_3} e^{-2\pi i l n_3} \right\}. \end{aligned}$$

► Sums, in principle, go over  $-\infty < n_i < \infty$ , or at least over a very large range  $1 \leq n_i \leq N_i$ .

► Phases lead to cancellation unless  $h$ ,  $k$  and  $l$  are integers, when each term is 1 and total amplitude is  $SN_1N_2N_3$ .

► So we see

▷ we have a strong reflection when  $\Delta\mathbf{k}$  is a reciprocal lattice vector;

▷ remembering that  $\Delta\mathbf{k}$  is perpendicular to the reflecting plane, an  $(hkl)$  reflection has  $\Delta\mathbf{k} = h\mathbf{A} + k\mathbf{B} + l\mathbf{C}$ .

### 2.7 The Laue Construction

► The Laue Construction is a diagram in the *reciprocal lattice*.

► Just as the lattice is an abstract mathematical object, so is the reciprocal lattice.

► Neither  $\mathbf{k}_i$  nor  $\mathbf{k}_f$  need to be reciprocal lattice vectors, but  $\mathbf{k}_f - \mathbf{k}_i$  is.

► Note that only certain special incident directions of  $\mathbf{k}_i$  will give a diffracted signal.

## 2.8 Non-Monatomic Structures

### 2.8.1 Simple Treatment

- ▶ Example: an FCC structure (thought of as simple cubic with a basis of two atoms, one at  $(0,0,0)$ , three more at  $(\frac{1}{2}, \frac{1}{2}, 0)$ ,  $(\frac{1}{2}, 0, \frac{1}{2})$ ,  $(0, \frac{1}{2}, \frac{1}{2})$ ).
- ▶ For simple cubic, there is a strong reflection from  $(110)$  planes:

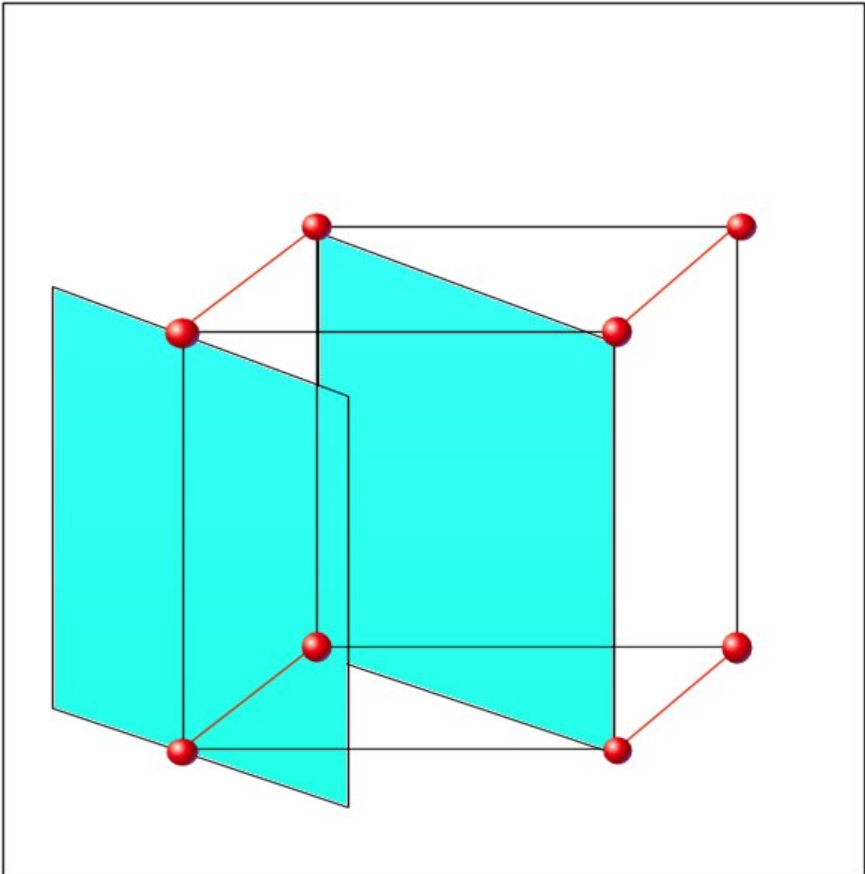
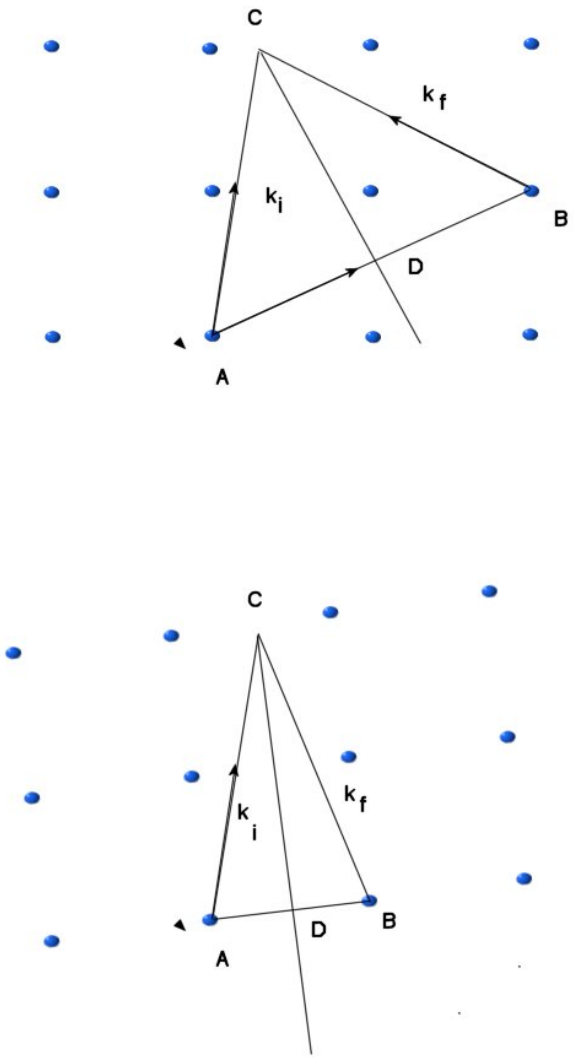

- ▶ But face-centred cubic has extra atoms in the original planes and between them:

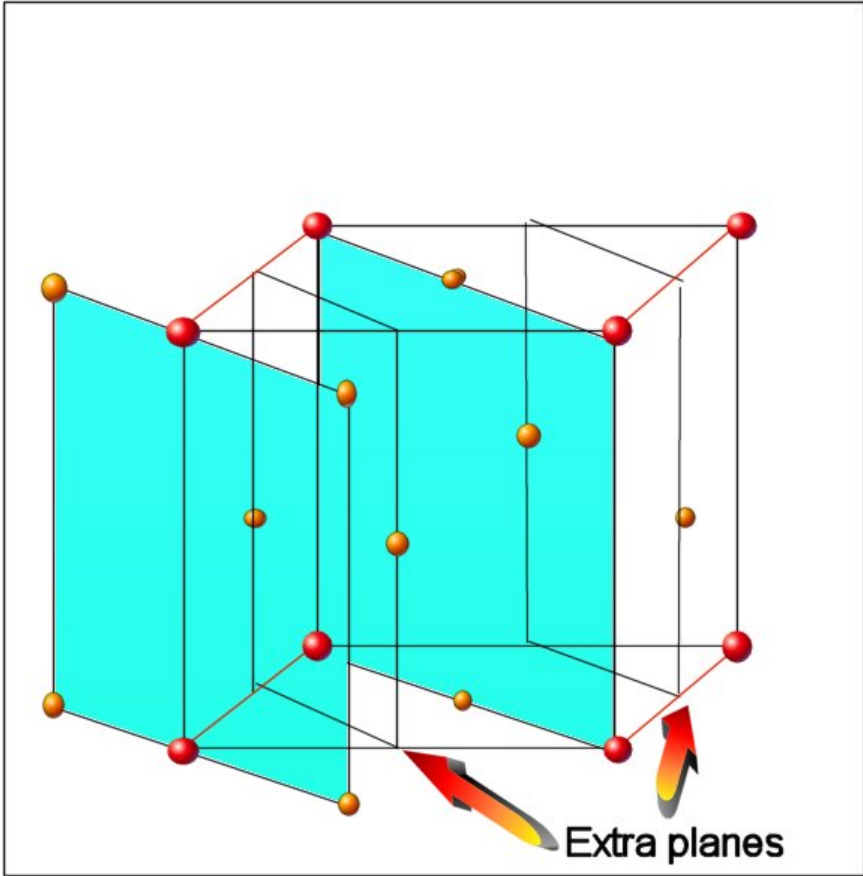

- ▶ These extra planes have the same number of atoms as the original (110) planes.
- ▶ But if the original planes correspond to a path length difference of  $\lambda$ , these have path length difference of  $\lambda/2$  – their signals will be *out of phase*.

- ▶ If the atoms are all the same, the (110) reflection will be missing.
- ▶ If the atoms are different, the amplitude of the (110) reflection will be reduced.
- ▶ These *missing orders* tell us something about the structures:
- ▶ Simple cubic has no missing orders;
- ▶ fcc: only see  $(hkl)$  where  $h, k$  and  $l$  are all even OR all odd.
- ▶ bcc: only see  $(hkl)$  where  $h + k + l$  is even.

### 2.8.2 Detailed Treatment

- ▶ Unit cell  $I$  has atoms of type  $j$  at positions  $\mathbf{r}_{Ii} = \mathbf{r}_I + \mathbf{r}_j$  each with scattering amplitude  $f_j$
- ▶ So total amplitude of the scattered wave is

$$\begin{aligned} \text{Total Amplitude} &\propto \sum_I \sum_j f_j \exp[-i\Delta\mathbf{k} \cdot (\mathbf{r}_I + \mathbf{r}_j)] \\ &= \left\{ \sum_I \exp[-i\Delta\mathbf{k} \cdot \mathbf{r}_I] \right\} \left\{ \sum_j f_j \exp[-i\Delta\mathbf{k} \cdot \mathbf{r}_j] \right\} \end{aligned}$$

- ▶ That is, we have the usual Bragg condition, but it is *multiplied* by the *structure factor*

$$S(\Delta\mathbf{k}) = \sum_j f_j \exp[-i\Delta\mathbf{k} \cdot \mathbf{r}_j].$$

- ▶ We know that  $\Delta\mathbf{k}$  is a reciprocal lattice vector, so if atom  $j$  is at  $x_j\mathbf{a} + y_j\mathbf{b} + z_j\mathbf{c}$

$$S(\Delta\mathbf{k}) = S(hkl) = \sum_j f_j \exp[-2\pi i(hx_j + ky_j + lz_j)].$$

### 2.8.2.1 Example – bcc structure

- ▶ Identical atoms at  $(0, 0, 0)$  and  $(\frac{1}{2}, \frac{1}{2}, \frac{1}{2})$ ,

$$\begin{aligned} S(hkl) &= f \left[ e^{2\pi i(0+0+0)} + e^{2\pi i(\frac{h}{2} + \frac{k}{2} + \frac{l}{2})} \right] \\ &= f \left[ 1 + e^{\pi i(h+k+l)} \right] \end{aligned}$$

- ▶ Clearly,  $S(hkl) = 0$  if  $h + k + l$  is odd (missing orders again).

## 2.9 Other Information

Strictly,  $S(hkl)$  involves an *integral* of the scattering over the unit cell:

- ▶ x-rays can give electron density maps, which tell us about binding
- ▶ neutrons interact with nuclei
- ▶ neutrons have spin and magnetic moment, so can give information about magnetic structure.

# Chapter 3

## Bonding in Crystals

### 3.1 Preliminaries

#### 3.1.1 Required Knowledge

- ▶ Structure of the atom
- ▶ Potential energy
- ▶ Coulomb's law
- ▶ Electric field
- ▶ Electric dipole
- ▶ Wavefunctions
- ▶ Integration and differentiation
- ▶ Pauli exclusion principle
- ▶ Free energy

#### 3.1.2 Reading

- ▶ Hook and Hall 1.6

### 3.2 Types of Bond

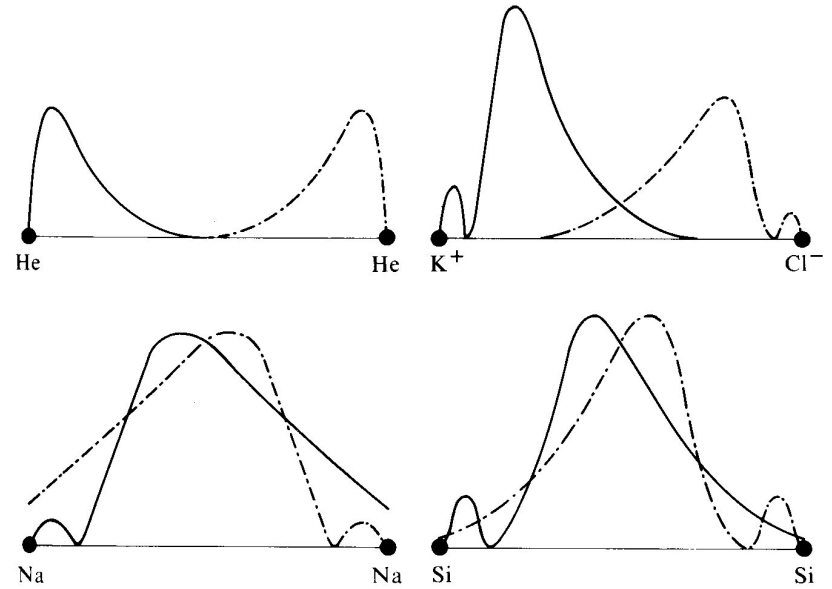
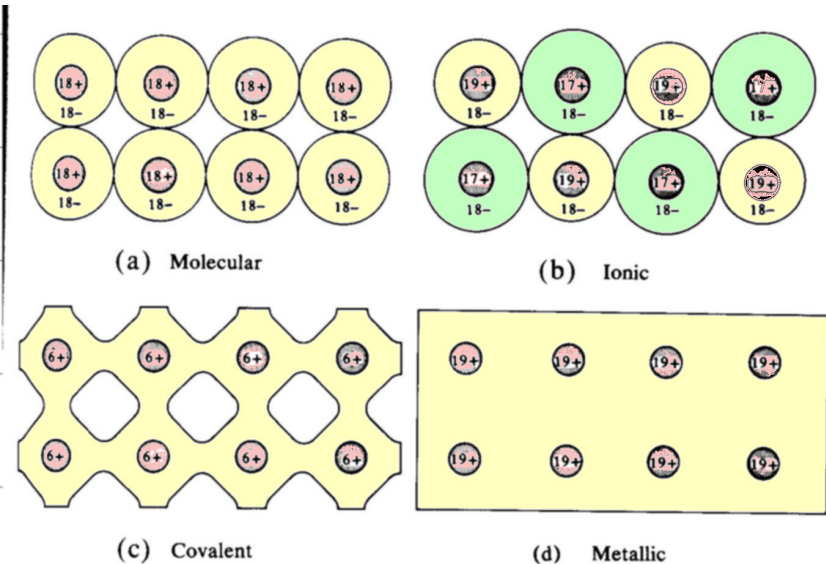

Type of Bond	Characteristics
Molecular or van der Waals	closed shell atoms or molecules
Ionic	closed shell ions
Covalent	directed bonds between atoms
Metallic	delocalised electrons with ion cores embedded
Hydrogen bond	specific to H atom between electronegative species

► Examples of hydrogen bonding:  $H - F - \cdots H - F - \cdots H - F$  or  $H - O - H - \cdots H - O - H - \cdots$

► Real materials involve bonds of mixed character.

### 3.3 Interatomic Potential Curves

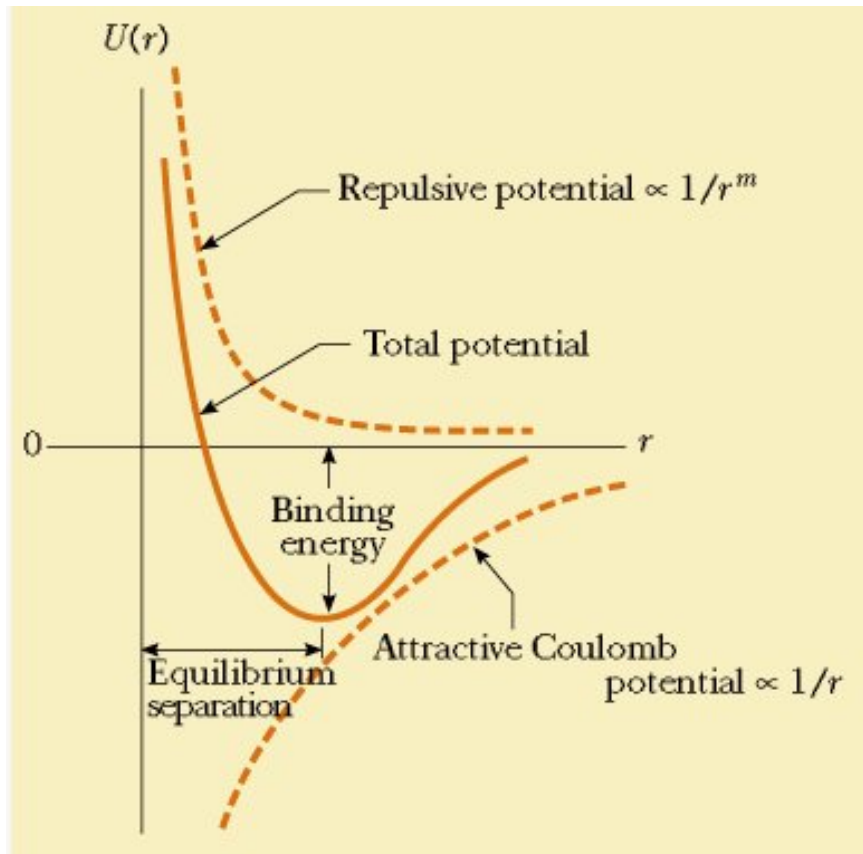

- ▶ Often thought of as sum of long-range attraction and short-range repulsion.
- ▶ Really a complex quantum-mechanical problem.
- ▶ The *shape* of the curve is similar, whatever the bonding (repulsive core, attractive tail).

- ▶ Assume for the moment only nearest-neighbour interactions.

- ▷ Well depth gives binding energy.
- ▷ Position of minimum gives interatomic spacing.
- ▷ Curvature at minimum determines bulk modulus.

$$p = -\frac{\partial E}{\partial V}$$

$$B = -V \frac{\partial p}{\partial V} = V \frac{\partial^2 E}{\partial V^2}$$

- ▶ Departure from symmetric shape determines thermal expansion.
- ▶ Few experiments (high-pressure shocks; high temperatures) explore potential curve far from minimum.



### 3.4 van der Waals Interaction

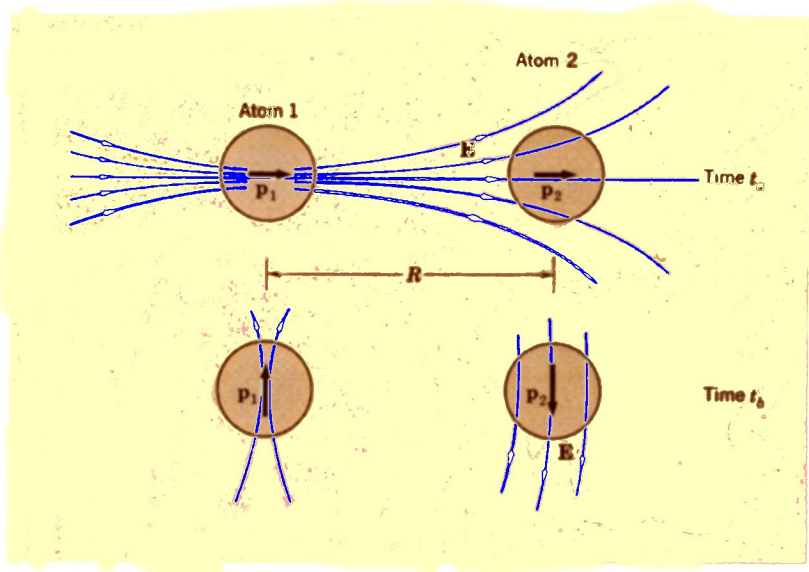

Classical picture: interaction between instantaneous dipoles.

- ▶ atom acquires dipole moment  $p$
- ▶ this gives electric field  $\mathcal{E} \propto \frac{p}{r^3}$  at  $r$
- ▶ an atom at  $r$  with polarisability  $\alpha$  acquires a dipole moment  $p' = \alpha\mathcal{E}$  parallel to  $\mathcal{E}$
- ▶ this give a field back at the original atom  $\mathcal{E}' \propto \frac{p'}{r^3} \propto \frac{\alpha p}{r^6}$
- ▶ the energy of the original dipole in this field is  $E = -p \cdot \mathcal{E}' \propto \frac{1}{r^6}$
- ▶ van der Waals interaction
  - ▷  $\propto \frac{1}{r^6}$

- ▷ isotropic
- ▷ always attractive
- ▷ quite weak – about 0.01 to 0.1 eV/atom pair

#### 3.4.1 Short-range repulsion

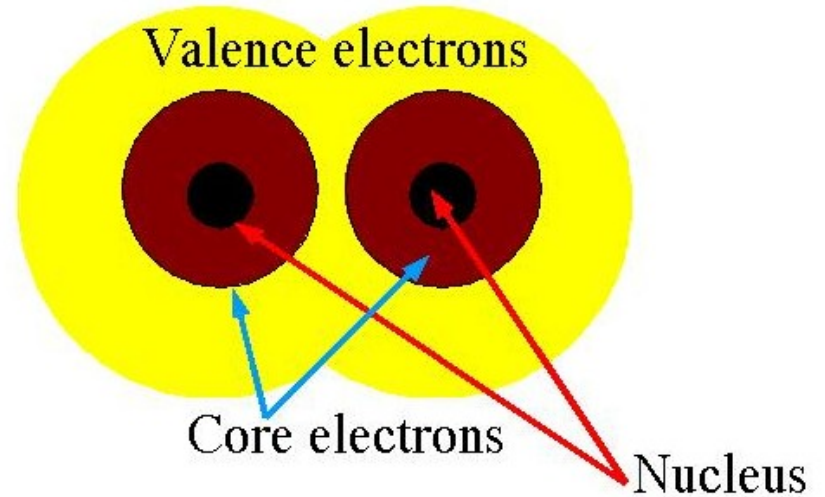

Physical origin is the Pauli exclusion principle.

- ▶ Inside the electrons which form chemical bonds there are closed shells (except for H – hence special H bond)
- ▶ Try to overlap these cores, electrons from one atom try to occupy ground state orbitals of the other
- ▶ But these states are already occupied
- ▶ Electrons must move to higher-energy states

- ▶ Extent to which this happens depends on overlap of wavefunctions
- ▶ Energy Increases rapidly with decreasing separation
- ▶ Often taken as
  - ▷ high power of  $r$ :  $E_{\text{rep}} \propto \frac{1}{r^{12}}$  or
  - ▷ exponential:  $E_{\text{rep}} \propto e^{-r/a}$ .
  - ▷ These are approximations to the true form

Another way of thinking about the repulsive terms:

- ▶ Wavefunctions for different states must be orthogonal (think back to atomic physics).
- ▶ For atoms that are far apart, this is true, as their wavefunctions do not overlap:  $S_{12} = \int \phi_1 \phi_2 = 0$ .
- ▶ When they overlap, we can make new functions that are orthogonal by defining  $\psi_1 = \phi_1 - S_{12}\phi_2$  and  $\psi_2 = \phi_2$  (one can make this more symmetrical, but it's messier)
- ▶ Then  $\int \psi_1 \psi_2 = \int (\phi_1 - S_{12}\phi_2)\phi_2 = 0$
- ▶ But the price we pay is to introduce more structure into  $\psi_1$ , and more structure means more curvature means more kinetic energy,
- ▶ So the overlap pushes up the energy.

## 3.5 van der Waals Solids

Examples:

- ▶ rare gas solids (spherical atoms)
- ▶ molecular crystals (e.g.  $\text{Cl}_2$ ,  $\text{C}_6\text{H}_6$ , polymers). More complex because of molecular shapes
- ▶ graphite (covalently bonded planes of carbon, but planes held together by van der Waals forces).

We consider only rare gas solids.

- ▶ Write pair interaction as *Lennard-Jones potential*:

$$U(r) = \frac{A}{r^{12}} - \frac{B}{r^6},$$

- ▶ or

$$U(r) = 4\epsilon \left[ \left( \frac{\sigma}{r} \right)^{12} - \left( \frac{\sigma}{r} \right)^6 \right].$$

- ▶ Typically  $\sigma$  is a few Å, say 0.3 nm.

### 3.5.1 Energy of van der Waals Solid

Obtain from pair-wise interactions by summing over all pairs.

- ▶ pick an atom, label it 0,
- ▶ let energy of interaction of this atom with neighbour  $i$  at a distance  $r_i$  be  $U(r_i)$

- ▶ total potential energy of the atom is

$$U_0 = \sum_i U(r_i)$$

- ▶ if there are  $N$  atoms altogether, each will have this same energy, *but* interaction  $0 - i$  is the same as  $i - 0$
- ▶ so total energy is

$$U = \frac{N}{2} \sum_i U(r_i).$$

We can separate structure (spatial arrangement) from length scale (interatomic separation).

- ▶ write  $r_i = \rho_i r_0$ , where  $r_0$  is nearest neighbour distance,  $\rho_i$  is dimensionless
- ▶ then

$$U(r_i) = 4\epsilon \left[ \frac{1}{\rho_i^{12}} \left( \frac{\sigma}{r_0} \right)^{12} - \frac{1}{\rho_i^6} \left( \frac{\sigma}{r_0} \right)^6 \right].$$

- ▶ summing,

$$U = 2N\epsilon \left[ A_{12} \left( \frac{\sigma}{r_0} \right)^{12} - A_6 \left( \frac{\sigma}{r_0} \right)^6 \right],$$

where

$$A_n = \sum_i \frac{1}{\rho_i^n}.$$

- ▶ these lattice sums can be done for any structure.

Structure	$A_{12}$	$A_6$
FCC	12.12188	14.45392
HCP	12.13229	14.45489
BCC	9.11418	12.25330

Note:

- ▶ expect sum of  $1/r^n$  to converge rapidly for large  $n$
- ▶  $A_{12}$  is dominated by the nearest neighbours (10 in FCC and HCP, 8 in BCC), but more distant neighbours affect  $A_6$

### 3.5.2 Equilibrium Separation

- ▶ The equilibrium structure minimises the total energy:  $\partial U / \partial r_0 = 0$ .

$$\frac{\partial U}{\partial r_0} = -2N\epsilon \left[ 12A_{12} \frac{\sigma^{12}}{r_0^{13}} - 6A_6 \frac{\sigma^6}{r_0^7} \right],$$

- ▶ which is zero when

$$\frac{r_0}{\sigma} = \left( \frac{2A_{12}}{A_6} \right)^{1/6}$$

- ▶  $\frac{r_0}{\sigma} = 1.09$  for FCC.

$$U = -\frac{A_6^2}{2A_{12}} \epsilon \text{ per atom.}$$

- ▶ Typically about 0.01 to 0.1 eV per atom.

### 3.5.3 Choice of Structure

- ▶ Expect structure to form crystals which have lowest energy, i.e. largest cohesive energy.
- ▶ Strictly, Gibbs free energy,  $G = U - TS + pV$ , but assume  $T = 0$  and  $p = 0$ .
- ▶ Neglect kinetic energy of atomic motion in  $U$ .

	SC	BCC	HCP	FCC
$A_6$	8.4	12.25	14.45	14.45
$A_{12}$	6.2	9.11	12.13	12.12
$U/N\epsilon$	-5.69	-8.24	-8.61	-8.62

- ▶ Note how close FCC and HCP are in energy (both have 12 nearest neighbours), but FCC is favoured.

### 3.5.4 Bulk Modulus

- ▶ We know energy as a function of separation: need to express as function of volume.
- ▶ For FCC structure, cubic lattice parameter  $a$ , nearest-neighbour separation  $r_0 = a/\sqrt{2}$ .
- ▶ Cubic unit cell, volume  $a^3$ , contains 4 atoms, so

$$\begin{aligned} \text{Volume per atom} &= \frac{a^3}{4} \\ &= \frac{r_0^3}{\sqrt{2}}. \end{aligned}$$

- ▶ Now we could use

$$\frac{\partial}{\partial V} = \frac{\partial r_0}{\partial V} \frac{\partial}{\partial r_0}$$

- ▶ but it's easier to substitute

$$r_0 = 2^{1/6} V^{1/3} N^{-1/3}$$

- ▶ in

$$U = 2N\epsilon \left[ A_{12} \left( \frac{\sigma}{r_0} \right)^{12} - A_6 \left( \frac{\sigma}{r_0} \right)^6 \right],$$

- ▶ to get

$$U = 2N\epsilon \left[ A_{12} \frac{\sigma^{12} N^4}{4V^4} - A_6 \frac{\sigma^6 N^2}{2V^2} \right]$$

- ▶ and hence

$$\frac{\partial^2 U}{\partial V^2} = 2N\epsilon \left[ A_{12} \frac{20\sigma^{12} N^4}{4V^6} - A_6 \frac{6\sigma^6 N^2}{2V^4} \right]$$

- ▶ so

$$B = N\epsilon \left[ A_{12} \frac{10\sigma^{12} N^4}{V^5} - A_6 \frac{6\sigma^6 N^2}{V^3} \right].$$

- ▶ But in equilibrium

$$r_0 = \sigma \left( \frac{2A_{12}}{A_6} \right)^{1/6},$$

- ▶ so

$$V = N\sigma^3 \sqrt{\left( \frac{A_{12}}{A_6} \right)}$$

► and

$$B = N\epsilon \left[ 10A_{12}\sigma^{12}N^4 \times \frac{1}{N^5\sigma^{15}} \left( \frac{A_6}{A_{12}} \right)^{5/2} - 6A_6\sigma^6N^2 \times \frac{1}{N^3\sigma^9} \left( \frac{A_6}{A_{12}} \right)^{3/2} \right],$$

► which simplifies to

$$B = \frac{4A_6^{5/2}\epsilon}{A_{12}^{3/2}\sigma^3}.$$

► Check: units are  $Energy/Length^3 = Force/Area = Stress$ .

### 3.6 Ionic Crystals

► The picture of an assembly of spherical ions is a good one:

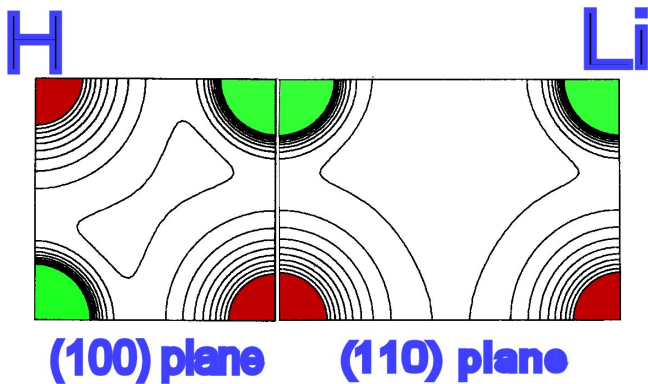

(Theoretical calculations by Harker, checked against experiment)

#### 3.6.1 Ionic Radii and Packing

- In general, cation  $M^+$  and anion  $X^-$  have different radii.
- We expect lowest energy if we have as many cations as possible around each anion, and we avoid anions touching anions.
- We know that for equal-sized spheres FCC gives high packing.
- If we shrink the smaller ions, but keep the geometrical arrangement, eventually the larger ions will touch.

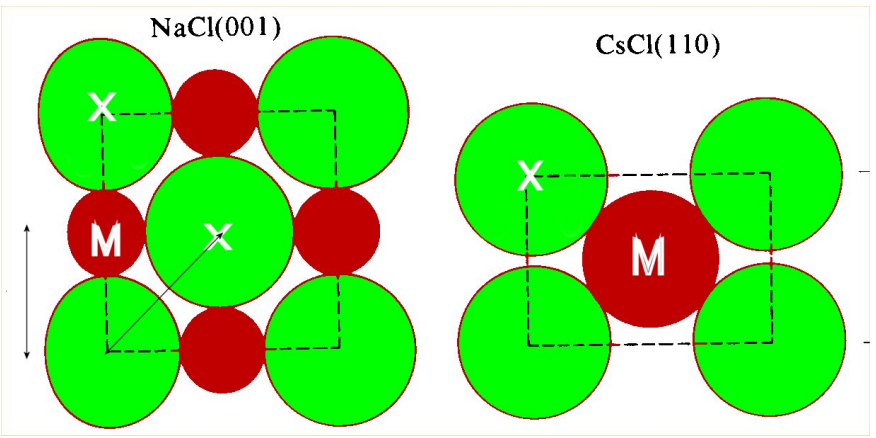

► NaCl:  $X$  atoms touch if

$$\begin{aligned}
 r_{MX} &= r_M + r_X \\
 r_{XX} &= \sqrt{2}r_{MX} \\
 r_{XX} \leq 2r_X &\Rightarrow \sqrt{2}(r_M + r_X) \leq 2r_X \\
 \Rightarrow \frac{r_X}{r_M} &\geq \frac{1}{\sqrt{2} - 1}.
 \end{aligned}$$

- ▶ CsCl:  $X$  atoms touch if

$$\begin{aligned} r_{MX} &= r_M + r_X \\ r_{XX} &= \frac{2}{\sqrt{3}} r_{MX} \\ r_{XX} \leq 2r_X &\Rightarrow \frac{2}{\sqrt{3}}(r_M + r_X) \leq 2r_X \\ \Rightarrow \frac{r_X}{r_M} &\geq \frac{1}{\sqrt{3} - 1}. \end{aligned}$$

- ▶ Given a table of ionic radii, we can guess structures of compounds.

### 3.6.2 Ionic Lattice Sums

- ▶ For a pair of ions,

$$U_{ij} = \frac{q_i q_j e^2}{4\pi\epsilon_0 r_{ij}} + U_{\text{rep}}(r_{ij}),$$

- ▶ and summing as before gives

$$U = \frac{N}{2} \left[ -\alpha_M \frac{e^2}{4\pi\epsilon_0 r_0} + U_{\text{rep}} \right].$$

- ▶  $\alpha_M$  is the *Madelung constant*, obtained by a lattice sum:

$$-\alpha_M = \sum_i \frac{q_0 q_i}{\rho_i}.$$

### 3.6.3 Linear Chain

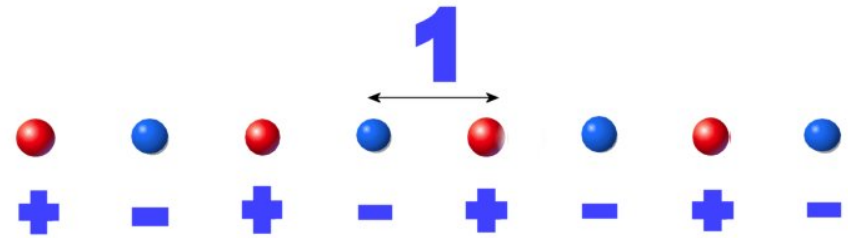

$$\alpha_M = 2 \left[ \frac{1}{1} - \frac{1}{2} + \frac{1}{3} - \dots \right]$$

Note:

- ▶ very slowly convergent
- ▶ only converges because it is an alternating series – try to sum only effect of, say, positive ions and get infinity
- ▶ Result:  $\alpha_M = 2 \ln(2) \approx 1.386$ .

### 3.6.4 Three dimensions

Special mathematical tricks used to calculate Madelung constant.

- ▶ Evcjen method: sum neutral regions, using increasingly large cubes and only counting half of charges on face centres, quarter of cube edges, eighth of cube corners
- ▶ Ewald method: trick involving real space and reciprocal space

Structure	coordination number	$\alpha_M$
CsCl	8	1.7627
NaCl	6	1.7476
Zinc blende (like GaAs)	4	1.6381
Wurtzite (hexagonal ZnS)	4	1.641

- ▶ Higher coordination gives larger Madelung constant.

### 3.6.5 Ionic Structures

- ▶ Structure will be that which minimises energy.

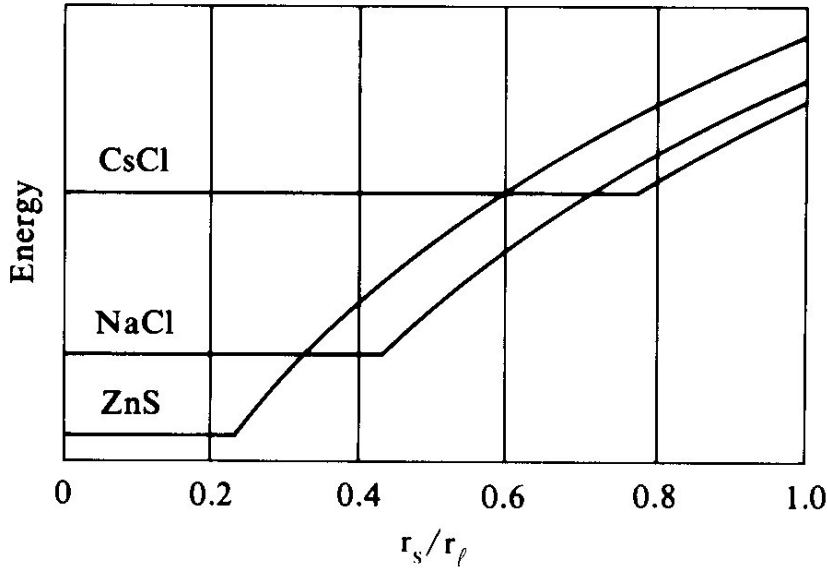

- ▶ Energy increasingly negative as ions get closer – until like ions touch.

- ▶ Radius ratios (smaller  $r_{small}$  over larger  $r_{large}$ ) give good guidance.
- ▶ Similar radii favour close packed structures
- ▶ Very different radii give more open, lower-coordinated (and more covalent) structures.

### 3.7 Metallic Bonding

- ▶ This can be thought of as an extreme case of ionic bonding in which the negative ions are just electrons.
- ▶ Because of their small mass, these valence have a large zero point energy that prevents them from being localised about one site.
- ▶ The valence electrons can be thought of as moving freely throughout the crystal.
- ▶ The core electrons remain bound to the nuclei. Thus we have

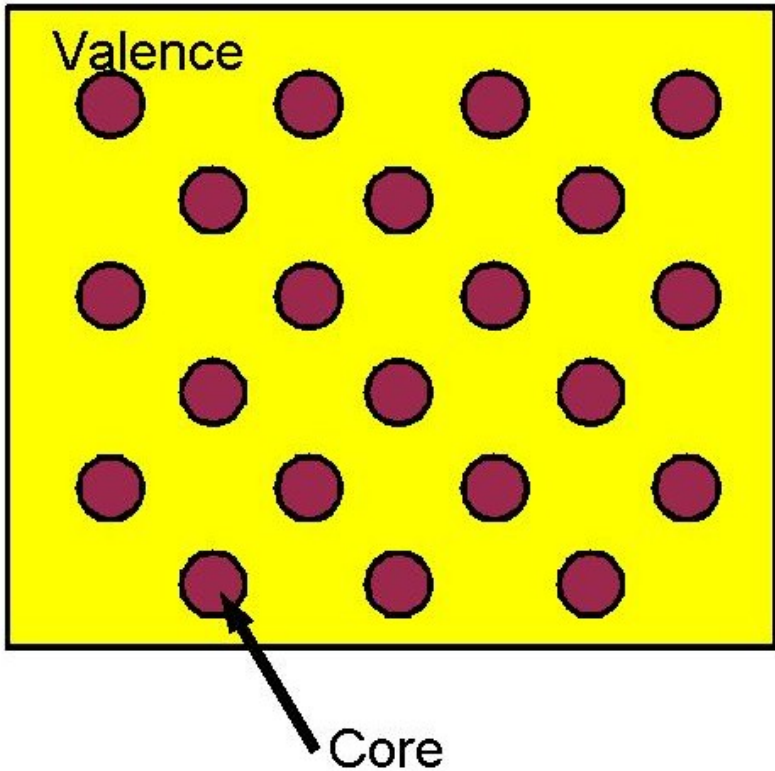

- ▶ The core electrons prevents the valence electrons from getting close to the nuclei (Pauli exclusion principle).
- ▶ The cores have a radius  $r_c$ .
- ▶ We assume that the valence electrons have a uniform density outside the cores with value

$$\frac{1}{\rho} = \frac{4}{3}\pi r_s^3$$

- ▶ For the alkali metals (Li, Na, K) we have one valence electrons per atom.
- ▶ The energy per atom is approximately given by

$$\begin{aligned} \frac{U}{Ry} &\approx \text{Kinetic} + \text{Electrostatic} + \text{Exchange} \\ &\approx \frac{2.212}{(r_s/a_0)^2} - \left( \frac{1.8}{(r_s/a_0)} - 3\frac{(r_c/a_0)^2}{(r_s/a_0)^3} \right) - \frac{0.919}{(r_s/a_0)} \end{aligned}$$

- ▶ Ry = Rydberg = Energy of hydrogen atom in its ground state
- ▶  $a_0$  = Bohr radius = radius of the 1s atomic orbital in hydrogen
- ▶ We shall discover where the kinetic energy term comes from later in this lecture course
- ▶ The electrostatic energy includes both the interaction between electrons, and the Coulomb interaction between an electron and the nucleus. The  $1/r_s$  dependence follows from Coulomb's law.
- ▶ The core electrons push the valence electrons away from the core and so reduce the strength of the interaction between the electrons and the nucleus.
- ▶ The exchange interaction is a result of the Pauli exclusion principle.
  - ▷ Electrons with the same spin cannot occupy the same orbital.
  - ▷ Thus electrons with the same spin are kept away from each other



▷ So their electrostatic repulsion is reduced and hence the energy is reduced.

▶ Note that the energy depends only on the density of the valence electrons.

▶ The crystal lattice parameter is determined by the equilibrium electron density.

▷ For the alkali metals (which are body centred cubic crystals) they are related by

$$\frac{a^3}{2} = \frac{4}{3}\pi r_s^3$$

▷ The equilibrium lattice constant can thus be found from

$$\frac{\partial U}{\partial r_s} = 0$$

▷ Let us define the following

$$u = U/Ry \qquad x = r_s/a_0$$

$$c_1 = 2.719 \quad c_2 = 2.212 \quad c_3 = 3(r_c/a_0)^2$$

▷  $c_1$  corresponds to the electrostatic plus exchange terms,  $c_2$  corresponds to the kinetic energy, and  $c_3$  is the core correction term.

$$u = -\frac{c_1}{x} + \frac{c_2}{x^2} + \frac{c_3}{x^3}$$

$$\Rightarrow \frac{\partial u}{\partial x} = \frac{c_1}{x^2} - 2\frac{c_2}{x^3} - 3\frac{c_3}{x^4}$$

▷ At equilibrium  $x = x_0$ , hence

$$0 = \frac{c_1}{x_0^2} - 2\frac{c_2}{x_0^3} - 3\frac{c_3}{x_0^4}$$

$$\Rightarrow 0 = c_1 x_0^2 - 2c_2 x_0 - 3c_3$$

$$\Rightarrow x_0 = \left(\frac{c_2}{c_1}\right) \left[1 + \sqrt{1 + 3\frac{c_1 c_3}{c_2^2}}\right]$$

$$= 0.814 \left[1 + \sqrt{1 + 5(r_c/a_0)^2}\right]$$

Metal	$r_s/a_0$	$r_c/a_0$
Li	3.25	1.26
Na	3.93	1.65
K	4.86	2.18
Rb	5.20	2.37
Cs	5.62	2.60

▶ Note that the ion cores increase in size as we go down the periodic table.

▶ In reality the electron density is not completely uniform, and this leads to a second term in the energy which is a pair interaction similar to the ones seen above.

### 3.8 Covalent Bonding

▶ Covalent bonds form between atoms with partially filled outer electron shells.

▶ If one atom bonds to two others, then the energy of the system depends strongly on the angle between the two bonds (the bonds are *directed*).

- ▶ A covalent bond involves the pairing up of two electrons, one from each atom per bond. Since there are a small number of unpaired electrons in the outer shell, one atom can only be involved in a few covalent bonds (the bonds are *saturable*).

# Chapter 4

## Dynamics of Crystals

### 4.1 Preliminaries

#### 4.1.1 Required Knowledge

- ▶ Newton's second law
- ▶ Hook's law
- ▶ Harmonic oscillator (classical and quantum)
- ▶ Determinants
- ▶ Complex exponentials
- ▶ Photon
- ▶ Calculus
- ▶ Statistical mechanics

#### 4.1.2 Reading

- ▶ Hook and Hall 2.1-2.8

### 4.2 Introduction

- ▶ Even in their ground states, the atoms have some kinetic energy (zero-point motion)
- ▶ Changes in temperature change the occupancy of the energy levels – heat capacity
- ▶ Motion affects the entropy, and hence the free energy – can affect the equilibrium structure
- ▶ Atomic motion affects the strength of diffraction patterns
- ▶ Vibrational energy can move through the structure

- ▷ sound waves
- ▷ heat transport

- ▶ Atoms away from regular sites alter the way electrons move through solids – electrical resistance

### 4.3 Chains of Atoms

- ▶ We shall start by assuming that every atom's interactions with its neighbours may be represented by a spring, so that the force in each 'spring' is proportional to the change in length of the spring.
- ▶ This is called the *harmonic approximation*. We'll talk about it more later.
- ▶ Also assume that only forces between nearest neighbours are significant

#### 4.3.1 Longitudinal Waves on Linear Chain

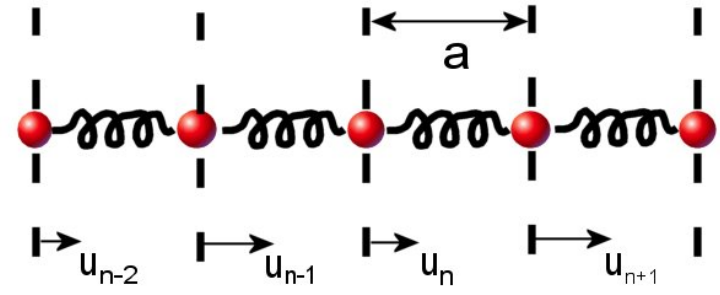

- ▶ Atom  $n$  should be at a position  $na$ , but is displaced by an amount  $u_n$ .
- ▶ The 'unstretched string' corresponds to an interatomic spacing  $a$ .
- ▶ So the force on atom  $n$  is

$$F_n = \alpha(u_{n+1} - u_n) - \alpha(u_n - u_{n-1}),$$

where  $\alpha$  is the spring constant.

- ▶ Thus the equation of motion is

$$m\ddot{u}_n = \alpha(u_{n+1} + u_{n-1} - 2u_n),$$

for atoms of mass  $m$ .

► Now look for wave-like solutions,

$$u_n(t) = A \exp(ikna - i\omega t),$$

and substitute to find

$$\begin{aligned} -m\omega^2 &= \alpha (e^{ika} + e^{-ika} - 2) \\ \omega^2 &= \frac{\alpha}{m} (2 - 2 \cos(ka)) \\ &= \frac{4\alpha}{m} \sin^2(ka/2). \end{aligned}$$

► This gives us the *dispersion relation*

$$\omega = \omega_0 \left| \sin \left( \frac{ka}{2} \right) \right|,$$

with a maximum cut-off frequency

$$\omega_0 = \sqrt{\frac{4\alpha}{m}}.$$

Dispersion relation in extended zone

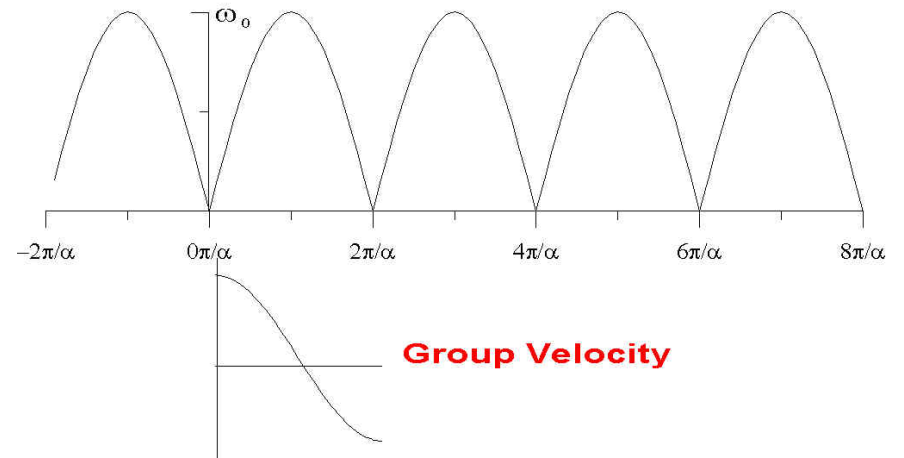

- *Group velocity*  $v_g = \frac{\omega_0 a}{2} \cos \left( \frac{ka}{2} \right)$
- Limit of long wavelength  $k \rightarrow 0$ ,

$$\omega \rightarrow \frac{\omega_0 ka}{2},$$

and so in this limit

$$v_p = v_g = \frac{\omega_0 a}{2}.$$

This is the normal sound velocity.

- Knowing  $v_p \approx 10^3 \text{ m s}^{-1}$  and  $a \approx 10^{-10} \text{ m}$ , we find

$$\omega_0 \approx 10^{13} \text{ rad s}^{-1},$$

so that maximum frequencies of lattice vibrations are THz ( $10^{12} \text{ Hz}$ ). In the infrared range.

### 4.3.2 The Brillouin Zone

- ▶ The dispersion is periodic in  $k$ . The frequency at  $k$  is the same as at  $k + 2\pi/a$ .

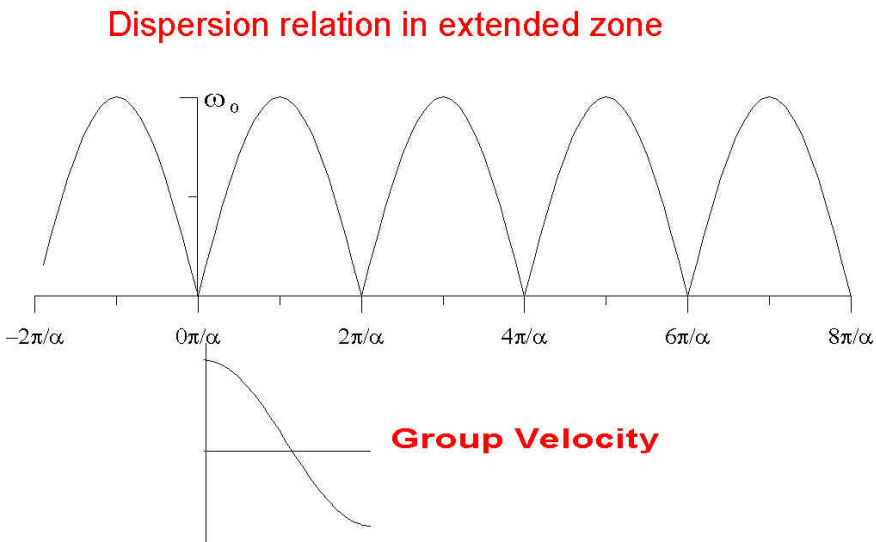

- ▶ We only sample the wave at the atomic positions, so we cannot tell the waves  $k$  and  $k + 2\pi/a$  apart.

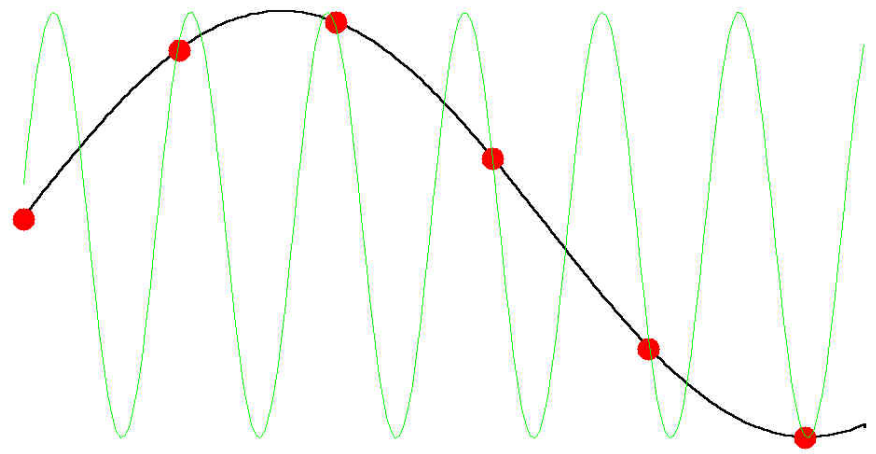

- ▶ Conventionally, we only consider the wavevectors between  $-\pi/a$  and  $\pi/a$ .
- ▶ This region corresponds to a *unit cell in reciprocal space*.
- ▶ Symmetrical treatment of waves travelling to right or left.
- ▶ Just as the physics is determined by the contents of a unit cell in real space, it is also determined by the behaviour of a unit cell in reciprocal space.

**4.3.3 More than one atom per cell**

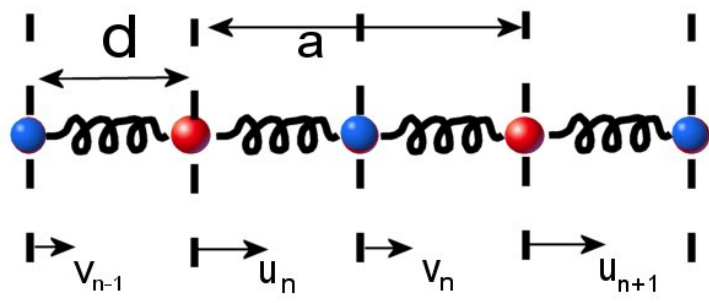

- ▶ Assume atoms of mass  $m$  are at  $u_n$ , atoms of mass  $M$  at  $v_n$ .
- ▶ Let the atoms be  $d = a/2$  apart, with the unit cell side still  $a$ .
- ▶ If the force constant is again  $\alpha$  we get coupled equations:

$$\begin{aligned}
 m\ddot{u}_n &= \alpha(v_n + v_{n-1} - 2u_n) \\
 M\ddot{v}_n &= \alpha(u_n + u_{n+1} - 2v_n).
 \end{aligned}$$

- ▶ Again look for travelling waves,

$$u_n(t) = A \exp(ikna - i\omega t) \quad v_n(t) = B \exp\left(ik\left(n + \frac{1}{2}\right)a - i\omega t\right).$$

- ▶ Substitute

$$\begin{aligned}
 m\omega^2 A &= 2\alpha(A - B \cos(ka/2)) \\
 M\omega^2 B &= 2\alpha(B - A \cos(ka/2))
 \end{aligned}$$

or

$$\begin{aligned}
 0 &= (2\alpha - m\omega^2)A - 2\alpha \cos(ka/2)B \\
 0 &= -2\alpha \cos(ka/2)A + (2\alpha - M\omega^2)B
 \end{aligned}$$

- ▶ This is a pair of linear homogeneous equations in  $A$  and  $B$ , which only has a non-trivial solution if the determinant of the coefficients is zero, that is

$$\begin{aligned}
 \begin{vmatrix} 2\alpha - m\omega^2 & -2\alpha \cos(ka/2) \\ -2\alpha \cos(ka/2) & 2\alpha - M\omega^2 \end{vmatrix} &= 0 \\
 \Rightarrow (2\alpha - m\omega^2)(2\alpha - M\omega^2) - (2\alpha \cos(ka/2))^2 &= 0
 \end{aligned}$$

which has two solutions

$$\omega^2 = \alpha \left( \frac{1}{m} + \frac{1}{M} \right) \pm \alpha \sqrt{\left( \frac{1}{m} + \frac{1}{M} \right)^2 - \frac{4 \sin^2(ka/2)}{mM}}.$$

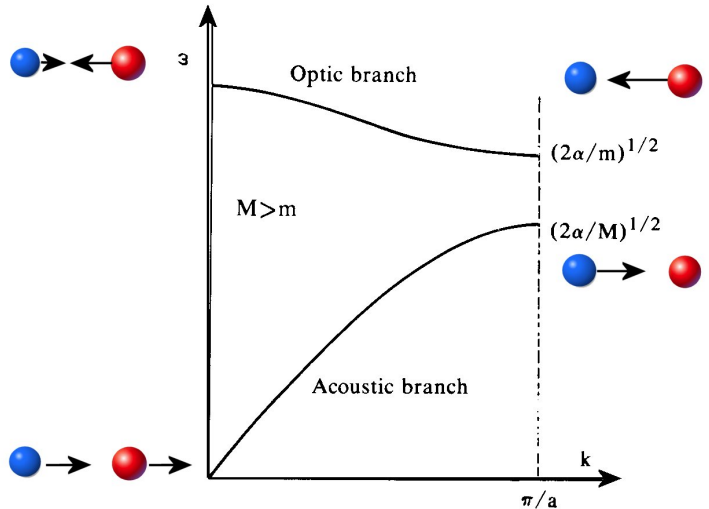

► Notes on diatomic linear chain:

- ▷ Acoustic branch has  $\omega = 0$  at  $k = 0$ .
- ▷ Optic branch has  $\omega \neq 0$  at  $k = 0$ .
- ▷ At  $k = 0$ 
  - ▷ on acoustic branch, atoms move in phase
  - ▷ on optic branch, atoms move in antiphase, keeping centre of mass of cell static.
  - ▷ if atoms have different charges, optic mode gives oscillating electric dipole moment to unit cell
  - ▷ dipole moment couples to electromagnetic field - hence optic mode
- ▷ At  $k = \pi/a$  only one atomic species moves in each mode.

4.3.4 Degenerate case of diatomic chain

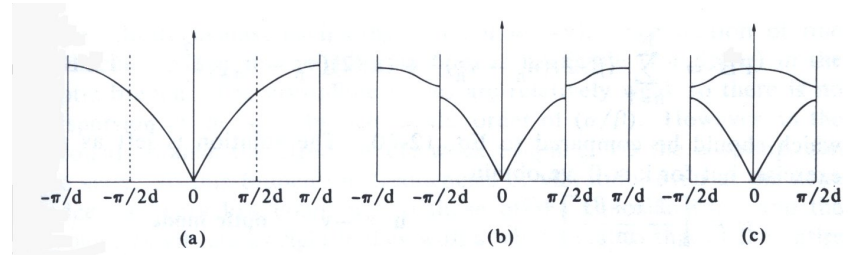

Diagrams showing the folding back of a Brillouin zone. (a)  $\omega$  vs.  $k$  in the first Brillouin zone  $k$  between  $\pm\pi/d$ . (b) The primitive unit cell has become twice as large so the Brillouin zone is twice as small. (c) The same as (b) but the pieces of the  $\omega$  vs.  $k$  curve are translated into the first Brillouin zone.

- If the masses become equal, the diatomic chain is identical with the monatomic chain except that the unit cell is larger than it need be.
- Larger unit cell in real space  $\Rightarrow$  smaller unit cell in reciprocal space ( $-\pi/a < k < \pi/a$ )
- Same *physics* from monatomic cell (one branch of spectrum), or diatomic cell (two branches).

4.3.5 Three dimensions

- Atoms can move in three directions (for chain, parallel + 2 transverse).
- Transverse force constants weaker, so transverse frequencies usually less than longitudinal
- Similarly, transverse wave speeds less than longitudinal



- ▶ 3-D monatomic crystal: 3 acoustic branches (L + 2T)
- ▶ Transverse branches degenerate along some symmetry directions.

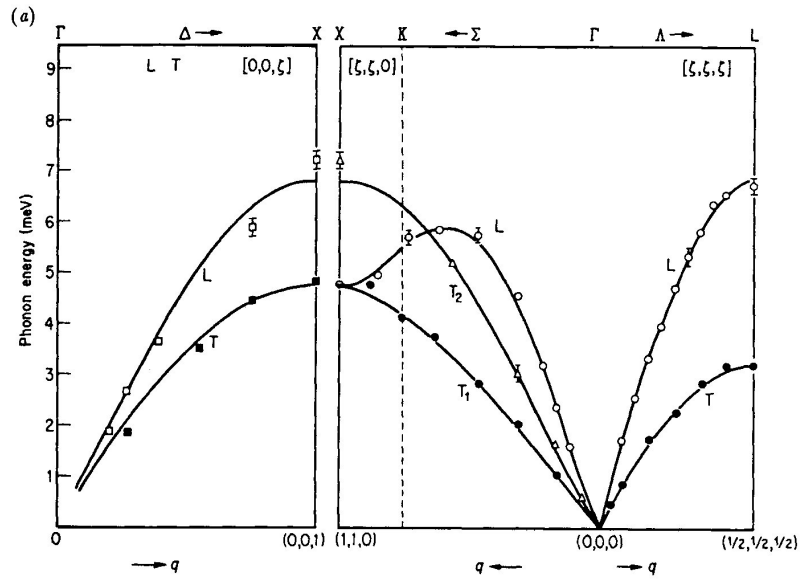
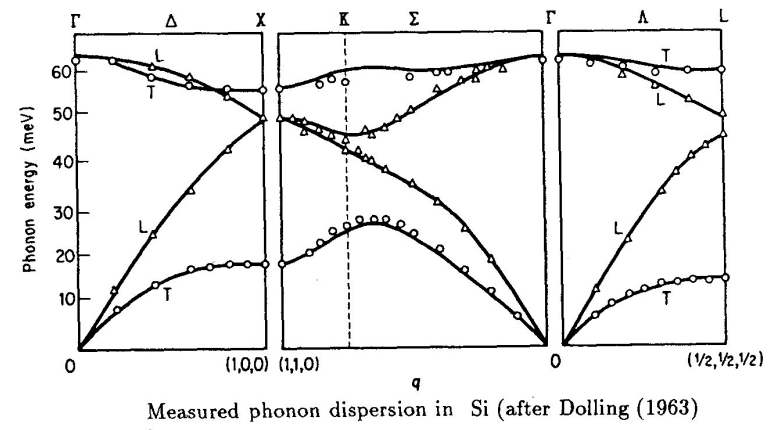

Figure (a) Measured phonon dispersion in Ne (after Leake *et al* (1969); reproduced from Elliott and Gibson (1982)).

- ▶ 3-D diatomic crystal: 3 acoustic branches (L + 2T) and 3 optical.



- ▶ In general:  $N$  atoms in the unit cell  $\rightarrow$  3 acoustic branches and  $3(N - 1)$  optical branches.

### 4.3.6 Measuring Phonon Spectra

- ▶ Phonon energy  $E = \hbar\omega \approx 10^{-34} 10^{13} = 10^{-21} \text{ J} \approx 0.01 \text{ eV}$
- ▶ Comparable with neutron energies
- ▶ Inelastic neutron scattering: measure  $\Delta k$  and  $\Delta E$ .

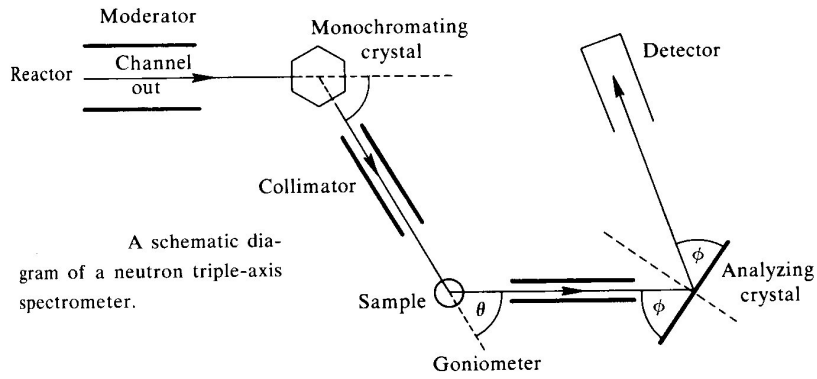

- ▶ Know input  $k$  and  $E$
- ▶ Scatter output beam from analyser crystal of known structure.
- ▶ From Bragg angles out of analyser, know wavelength of original scattered beam
- ▶ hence scattered energy, hence  $\Delta k$

### 4.4 Normal Modes

- ▶ In formal terms, the energy of the crystal is a function of the displacements of all the atoms from their equilibrium positions:

$$\begin{aligned}
 U(u_n) = U_0 &+ \frac{1}{2} \sum_{n,n'} u_n u_{n'} \left( \frac{\partial^2 U}{\partial u_n \partial u_{n'}} \right)_0 \\
 &+ \frac{1}{3!} \sum_{n,n',n''} u_n u_{n'} u_{n''} \left( \frac{\partial^3 U}{\partial u_n \partial u_{n'} \partial u_{n''}} \right) + \dots
 \end{aligned}$$

- ▶ Note that the linear term is zero. This is the definition of the equilibrium structure.
- ▶ In the *harmonic approximation*

$$U(u_n) = U_0 + \frac{1}{2} \sum_{n,n'} D_{nn'} u_n u_{n'}$$

add the kinetic energy

$$\sum_n \frac{p_n^2}{2m_n},$$

and then change variables, forming linear combinations of the form

$$u(k) = \sum_n u_n e^{ikr_n}.$$

These are the *normal modes*, in terms of which the Hamiltonian is diagonal.

- ▶ We find we can rewrite the Hamiltonian of the system in the form

$$H = \sum_k \left( n_k + \frac{1}{2} \right) \hbar \omega_k.$$

- ▶ In the harmonic approximation, the lattice vibrations are the same as a collection of harmonic oscillators, with frequencies  $\omega_k$ .
  - ▶ These normal modes do not interact: put energy into one mode  $k$  by altering  $n_k$  and it will stay in that mode.
  - ▶ The normal modes are called *phonons*.
  - ▶ The allowed values of  $k$  will be determined by the boundary conditions at the edges of the material.

## 4.5 Phonon Density of States

### 4.5.1 One Dimension - $g(k)$

- ▶ Take crystal of length  $L$ , and impose *periodic boundary conditions*, so that for a wave

$$\exp(ikx) = \exp(ik(x + L)),$$

so

$$\exp(ikL) = 1,$$

or

$$k = n \frac{2\pi}{L},$$

where  $n$  is an integer.

- ▶ The allowed states are uniformly distributed in reciprocal space ( $k$ -space) with spacing  $2\pi/L$ .
- ▶ The density of states is the inverse of the spacing,

$$g(k) = \frac{L}{2\pi}.$$

- ▶ The number of allowed states with wavevectors between  $k$  and  $k + dk$  is  $g(k) dk$ .
- ▶ Note that if there are  $N$  unit cells so that  $L = Na$  the total number of allowed states in the Brillouin zone is

$$\int_{-\pi/a}^{\pi/a} g(k) dk = \frac{L}{2\pi} \times 2\frac{\pi}{a} = \frac{L}{a} = N.$$

- ▶ The number of allowed states in the Brillouin zone is equal to the number of *unit cells* in the system.
- ▶ N.B. unit cells, not atoms. More atoms  $\rightarrow$  more degrees of freedom  $\rightarrow$  more branches of the spectrum.

### 4.5.2 Assumption of Continuous Energy

- ▶ How closely spaced are the energy levels?
- ▶ Suppose the crystal is 0.01 m long. Then the spacing between  $k$  values is  $\Delta k = 2\pi/L = 200\pi \text{ m}^{-1}$ .
- ▶ If the sound wave speed is  $v = 5000 \text{ m s}^{-1}$  then on the acoustic branch the minimum angular frequency is 0 and the next is  $\Delta\omega = v\Delta k = 5000 \times 200\pi = 10^6\pi \text{ rad s}^{-1}$ .
- ▶ This is small enough compared with the maximum frequency (about  $10^{13} \text{ rad s}^{-1}$ ) that replacing a sum over discrete frequencies with an integral is a good approximation.
- ▶ The energy spacing is  $\Delta E = \hbar\Delta\omega \approx 3 \times 10^{-28} \text{ J} = 2 \times 10^{-9} \text{ eV}$ .

**4.5.3 One Dimension:  $g(E)$  or  $g(\omega)$**

Dispersion relation in extended zone

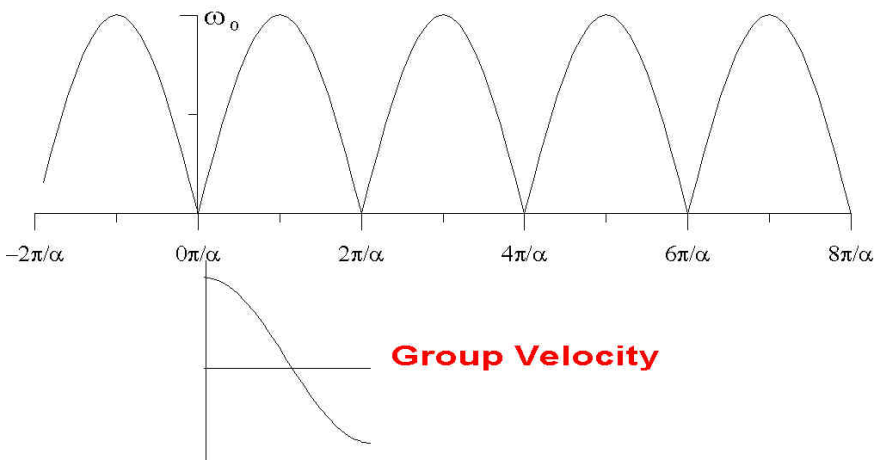

- ▶ Go from *evenly* spaced allowed values of  $k$  to, in general, *un-evenly* spaced values of energy.
- ▶ Note that positive and negative  $k$  have same  $E$ .
- ▶ Define the density of states in frequency: number of allowed states between  $\omega$  and  $\omega + d\omega$  is  $g(\omega) d\omega$ .
- ▶ This must be the same as the number in the region of  $k$ -space containing states in that frequency interval, so in  $0 < k < \pi/a$

$$g(\omega) d\omega = g(k) dk,$$

or

$$g(\omega) = g(k) \frac{dk}{d\omega} = g(k) / \frac{d\omega}{dk}.$$

- ▶ Allowing also for the states with negative  $k$  ( $\omega(k) = \omega(-k)$ ) we get in one dimension

$$g(\omega) = 2 \frac{L}{2\pi} \frac{dk}{d\omega}$$

$$\frac{d\omega}{dk} = v_g$$

where  $v_g$  is the group velocity of the wave.

- ▶ *Non-dispersive system*

▷  $v_g$  is constant, so

$$g(\omega) = \frac{L}{\pi v_g} = \text{constant.}$$

- ▶ *Monatomic chain*

$$\omega = \omega_0 \sin(ka/2)$$

$$v_g = \frac{a\omega_0}{2} \cos(ka/2)$$

$$= \frac{a\omega_0}{2} \sqrt{1 - \sin^2(ka/2)}$$

$$= \frac{a\omega_0}{2} \sqrt{1 - \omega^2/\omega_0^2}$$

$$= \frac{a}{2} \sqrt{\omega_0^2 - \omega^2}.$$

and then

$$g(\omega) = \frac{2L}{\pi a \sqrt{\omega_0^2 - \omega^2}}.$$

- One-dimensional density of states for real monatomic structure, non-dispersive system (Debye model), and real diatomic structure.

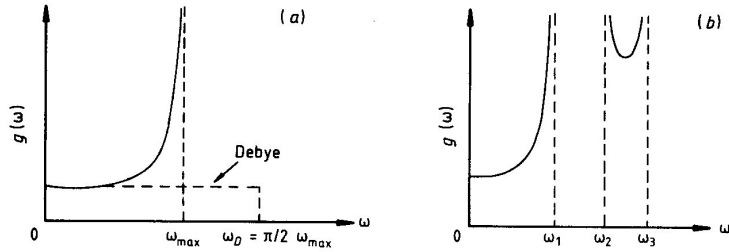

- Note that in one dimension we have singularities in the density of states whenever the  $\omega(k)$  curve is flat.

### 4.6 Three dimensions – $g(E)$ or $g(\omega)$

- Apply periodic boundary conditions along  $x$ ,  $y$  and  $z$ .
- The number of states in the reciprocal space volume  $dk_x dk_y dk_z$  is then

$$\frac{L_x L_y L_z}{(2\pi)^3} dk_x dk_y dk_z = \frac{V}{8\pi^3} dk_x dk_y dk_z,$$

for crystal volume  $V$ .

- Now assume that the crystal is *isotropic* –  $\omega$  depends only on magnitude of  $k$ , not its direction. Then

$$dk_x dk_y dk_z = 4\pi k^2 dk$$

and the number of states with modulus of wavevector between  $k$  and  $k + dk$  is

$$g(k)dk = \frac{V}{8\pi^3} 4\pi k^2 dk = \frac{V}{2\pi^2} k^2 dk$$

- Here we've accounted for all directions, so no extra factor of 2 as in one dimension when going to  $g(\omega)$ .
- But we do have to include all the modes (acoustic, optic, longitudinal, transverse), each with its own dispersion relation, so

$$g(\omega) = \frac{V}{2\pi^2} \sum_s k(\omega_s)^2 / \frac{d\omega_s}{dk},$$

where  $s$  denotes the mode.

- *Non-dispersive system*

- ▷ If we assume that

$$\omega_s(k) = v_s k,$$

i.e. the sound speed does not depend on frequency, we have

$$k(\omega_s) = \frac{\omega}{v_s},$$

and

$$\frac{dk}{d\omega_s} = \frac{1}{v_s},$$

so

$$g(\omega) = \frac{V}{2\pi^2} \sum_s \frac{\omega^2}{v_s^3}.$$

▷ If we define an average sound speed  $v$  by

$$\frac{1}{v^3} = \left\langle \frac{1}{v_s^3} \right\rangle,$$

where  $\langle \dots \rangle$  denotes an average. e.g.

$$\frac{1}{v^3} = \frac{1}{3} \left[ \frac{1}{v_L^3} + \frac{2}{v_T^3} \right],$$

then

$$g(\omega) = \frac{V}{2\pi^2} \frac{S\omega^2}{v^3}.$$

Here  $S$  is the number of branches in the phonon spectrum – 3 for a monatomic 3-D solid.

### 4.6.1 Special case - single frequency

► If we assume (the Einstein model)

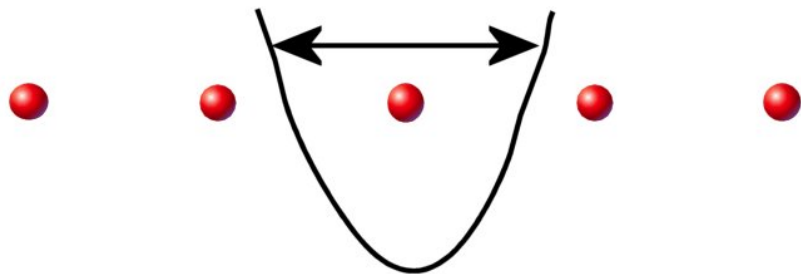

All atoms except one fixed - Einstein model

► we get a delta-function density of states.

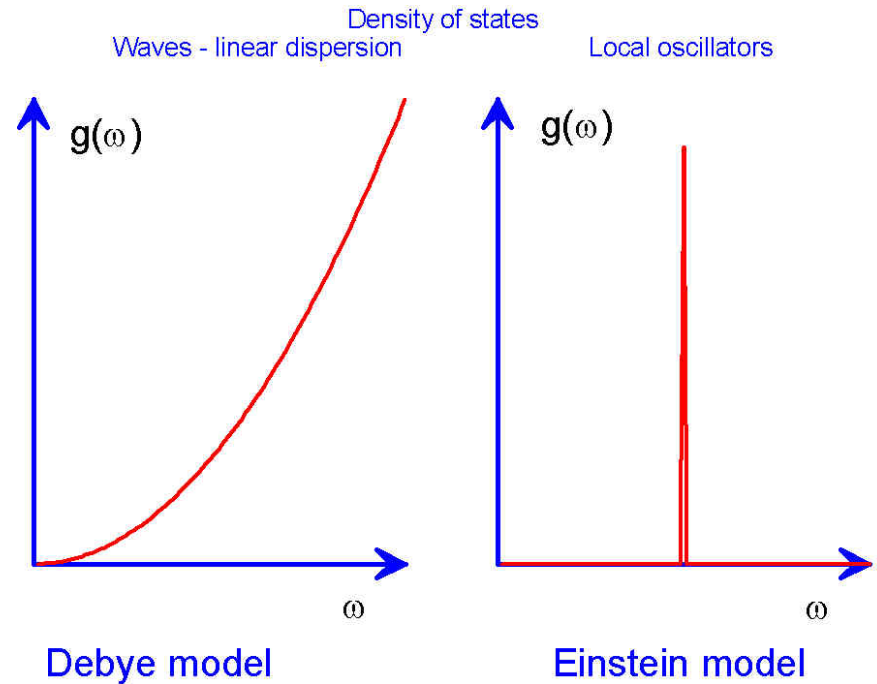

► N.B. Einstein model can be used as model of narrow optical branch of phonon spectrum.

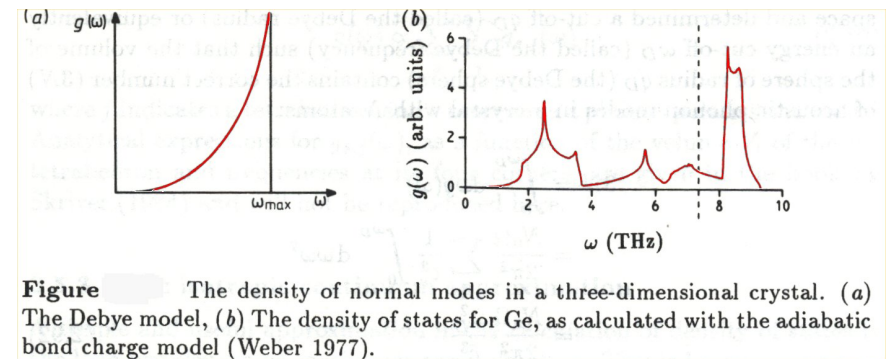

Figure The density of normal modes in a three-dimensional crystal. (a) The Debye model, (b) The density of states for Ge, as calculated with the adiabatic bond charge model (Weber 1977).

► Real density of states: complicated structure – no singulari-

ties (contrast 1-D), but discontinuities in slope.

### 4.6.2 Quantised Simple Harmonic Oscillator

- For an oscillator of frequency  $\omega$  in its  $n$ th energy level the partition function is

$$\begin{aligned}
 Z &= \sum_{n=0}^{\infty} \exp\left(-\frac{E_n}{k_B T}\right) \\
 &= \sum_{n=0}^{\infty} \exp\left(-\frac{(n + 1/2)\hbar\omega}{k_B T}\right) \\
 &= \frac{1}{2 \sinh\left(\frac{\hbar\omega}{2k_B T}\right)} \\
 &= \frac{1}{2 \sinh\left(\frac{\beta\hbar\omega}{2}\right)} \\
 \langle E \rangle &= -\frac{\partial \ln Z}{\partial \beta} = \left(\langle n \rangle + \frac{1}{2}\right)\hbar\omega,
 \end{aligned}$$

- The crucial result is the mean occupation number of the  $n$ th level:

$$\langle n \rangle = \frac{1}{\exp(\hbar\omega/k_B T) - 1},$$

for Bose-Einstein statistics.

- Higher frequency  $\Rightarrow$  lower occupancy at given temperature.

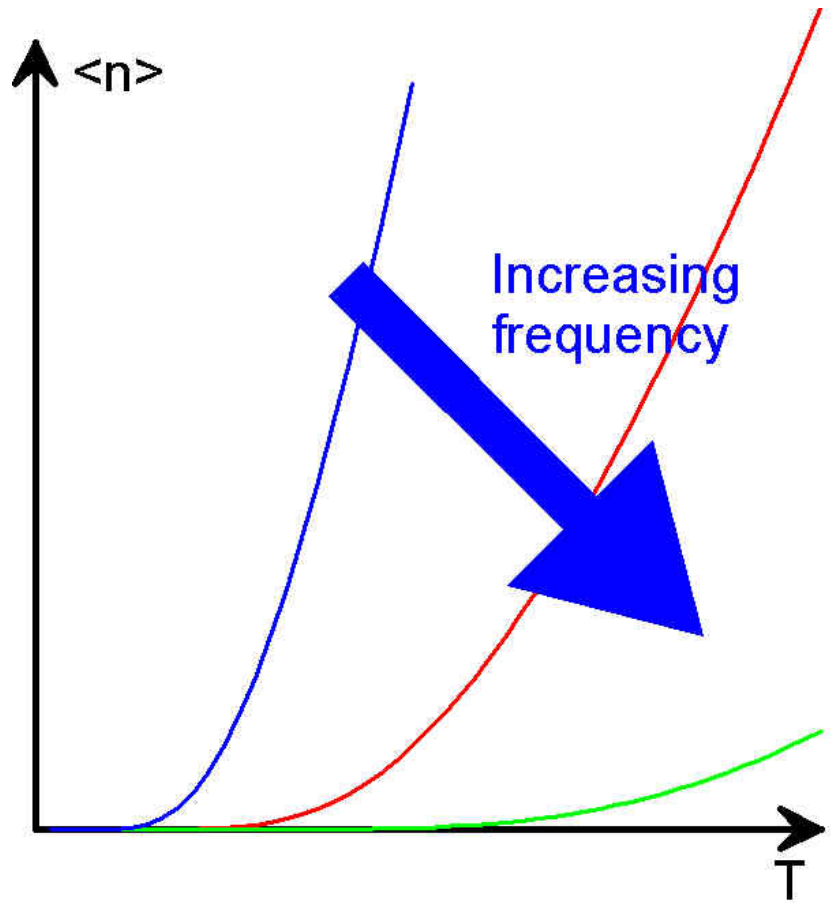

- Free energy

$$\begin{aligned}
 F &= -k_B \ln(Z) \\
 &= k_B T \ln\left(\sinh\left(\frac{\hbar\omega}{2k_B T}\right)\right)
 \end{aligned}$$

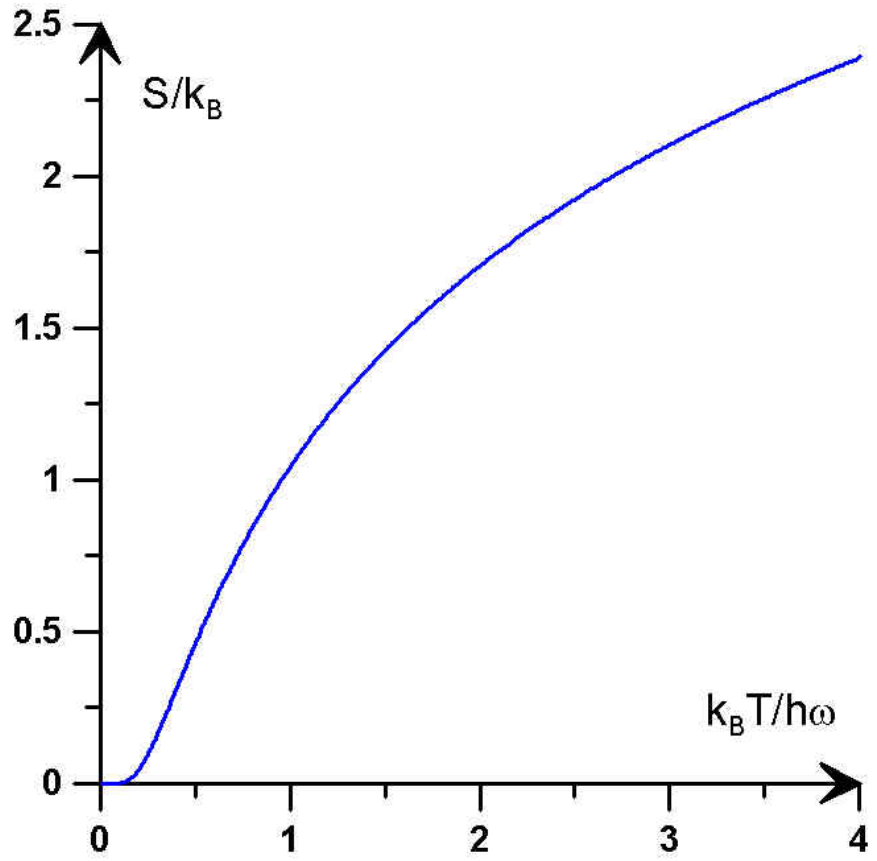
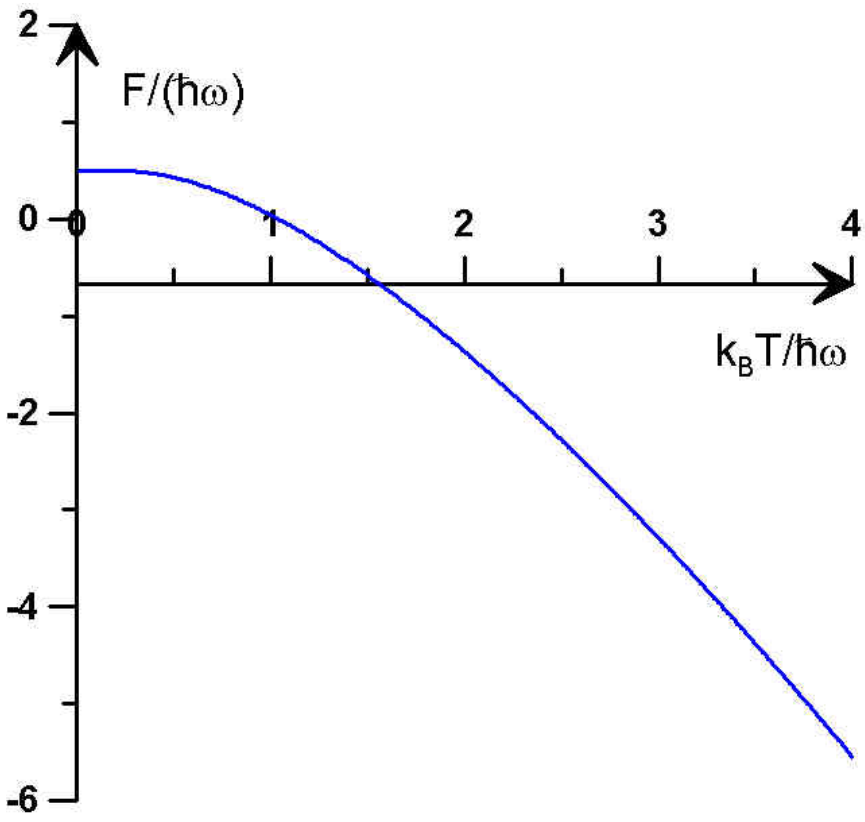

► Entropy

- ▷ The decrease in free energy with  $T$  is due to an increase in entropy. At  $p = 0$

$$S = \frac{E - F}{T}.$$

- ▷ Increase  $T$ , increase  $S$
- ▷ More displacement from equilibrium position means more disorder.

► Specific heat:

$$C = \frac{\partial E}{\partial T}.$$



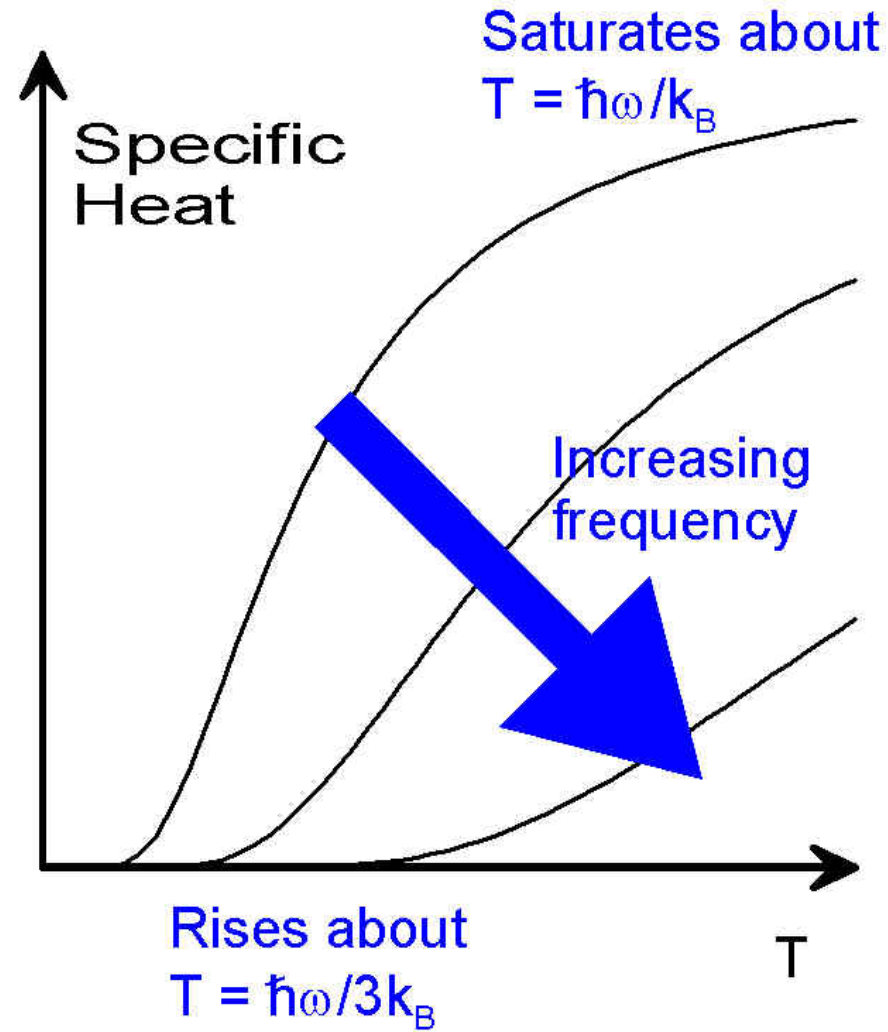

▷  $C$  universal function of  $T/\Theta$ , where  $\Theta = \hbar\omega/k_B$

### 4.7 Experimental Specific Heats

Element	Z	A	$C_p$ J K <sup>-1</sup> mol <sup>-1</sup>	Element	Z	A
Lithium	3	6.94	24.77	Rhenium	75	186.2
Beryllium	4	9.01	16.44	Osmium	76	190.2
Boron	5	10.81	11.06	Iridium	77	192.2
Carbon	6	12.01	8.53	Platinum	78	195.1
Sodium	11	22.99	28.24	Gold	79	197.0
Magnesium	12	24.31	24.89	Mercury	80	200.6
Aluminium	13	26.98	24.35	Thallium	81	204.4
Silicon	14	28.09	20.00	Lead	82	207.2
Phosphorus	15	30.97	23.84	Bismuth	83	209.0
Sulphur	16	32.06	22.64	Polonium	84	209.0

- ▷ low  $T$ : exponential dependence  $C \propto T^{-2} \exp(-\hbar\omega/k_B T)$
- ▷ intermediate  $T \approx \hbar\omega/3k_B$ : steep rise in  $C$
- ▷ high  $T > \hbar\omega/k_B$ :  $C$  saturates to classical result,  $C = k_B$  per oscillator.

### 4.8 Einstein's model

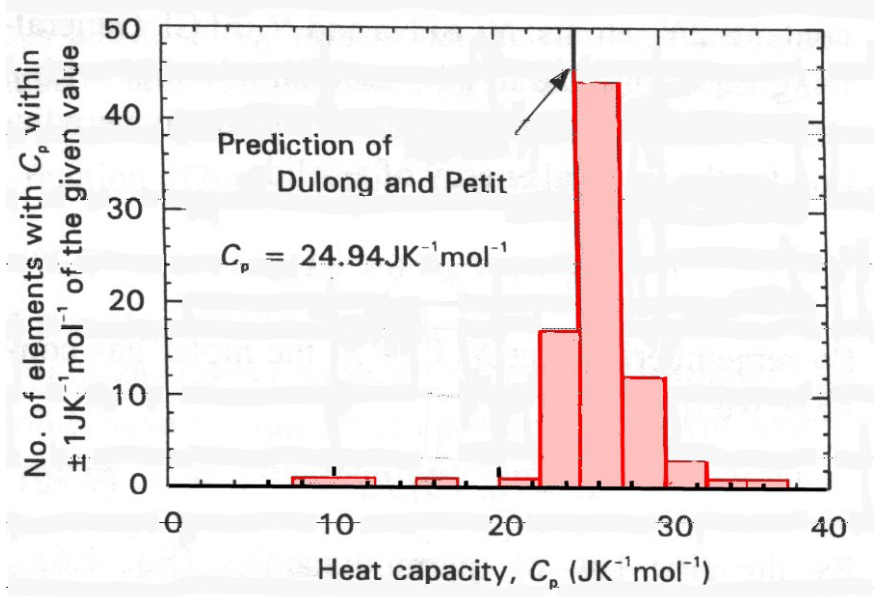

- ▶ Classical equipartition of energy gives specific heat of  $3pR$  per mole, where  $p$  is the number of atoms in the chemical formula unit.
- ▶ For elements,  $3R = 24.94 \text{ J K}^{-1} \text{ mol}^{-1}$ .
- ▶ Experiments by James Dewar showed that specific heat tended to decrease with temperature.

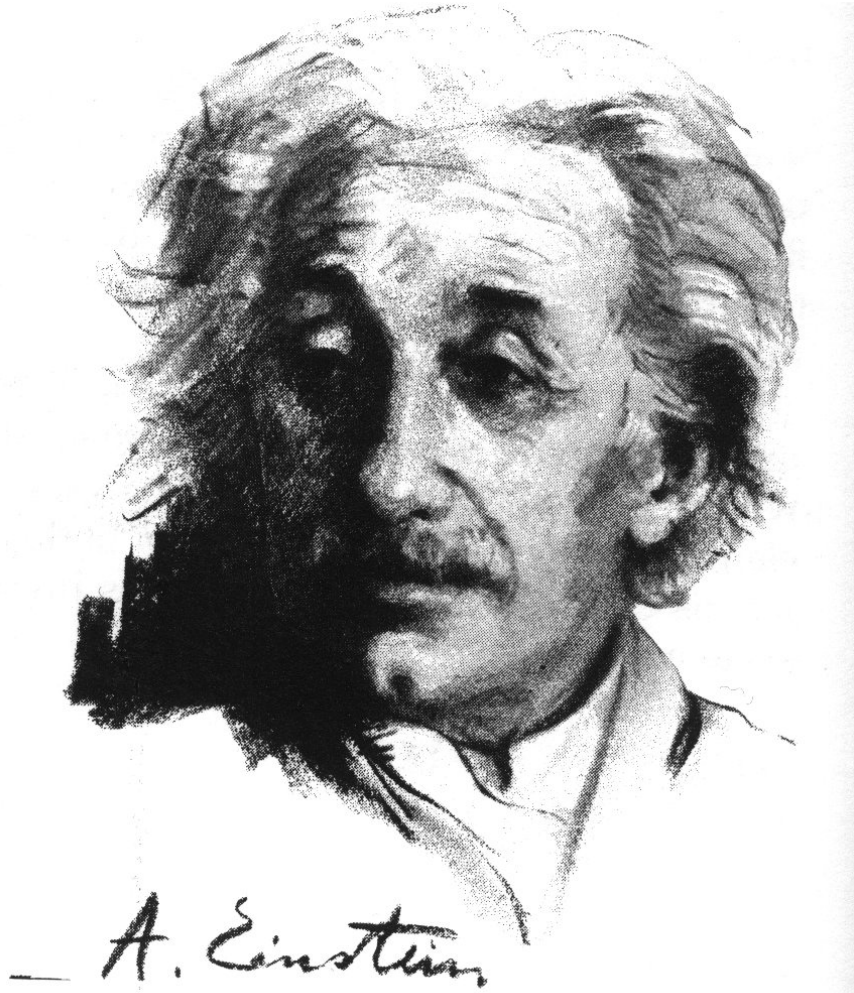

**Albert Einstein 1879–1955**

- ▶ Einstein (1907): “If Planck’s theory of radiation has hit upon the heart of the matter, then we must also expect to find contradictions between the present kinetic molecular theory and practical experience in other areas of heat theory, contradictions which can be removed in the same way.”
- ▶ If there are  $N$  atoms in the solid, assume that each vibrates with frequency  $\omega$  in a potential well. Then

$$E = N\langle n \rangle \hbar\omega = \frac{N\hbar\omega}{e^{\frac{\hbar\omega}{k_B T}} - 1}$$

$$C_V = \left( \frac{\partial E}{\partial T} \right)_V$$

▶ Hence

$$\left( \frac{\partial}{\partial T} \right) \frac{\hbar\omega}{k_B T} = -\frac{\hbar\omega}{k_B T^2}$$

$$\left( \frac{\partial}{\partial T} \right) e^{\frac{\hbar\omega}{k_B T}} = -\frac{\hbar\omega}{k_B T^2} e^{\frac{\hbar\omega}{k_B T}}$$

$$C_V = Nk_B \left( \frac{\hbar\omega}{k_B T} \right)^2 \frac{e^{\frac{\hbar\omega}{k_B T}}}{\left( e^{\frac{\hbar\omega}{k_B T}} - 1 \right)^2}$$

- ▶ When  $T \rightarrow \infty$ , then  $\frac{\hbar\omega}{k_B T} \rightarrow 0$ , so  $e^{\frac{\hbar\omega}{k_B T}} \rightarrow 1$  and  $e^{\frac{\hbar\omega}{k_B T}} - 1 \rightarrow \frac{\hbar\omega}{k_B T}$ , and

$$C_V \rightarrow Nk_B \left( \frac{\hbar\omega}{k_B T} \right)^2 \frac{1}{\left( \frac{\hbar\omega}{k_B T} \right)^2} = Nk_B.$$

This is the expected classical limit.

- ▶ When  $T \rightarrow 0$ , then  $e^{\frac{\hbar\omega}{k_B T}} \gg 1$  and

$$C_V \rightarrow Nk_B \left( \frac{\hbar\omega}{k_B T} \right)^2 \frac{e^{\frac{\hbar\omega}{k_B T}}}{\left( e^{\frac{\hbar\omega}{k_B T}} \right)^2} \rightarrow T^{-2} e^{-\frac{\hbar\omega}{k_B T}}.$$

Convenient to define Einstein temperature,  $\Theta_E = \hbar\omega/k_B$ .

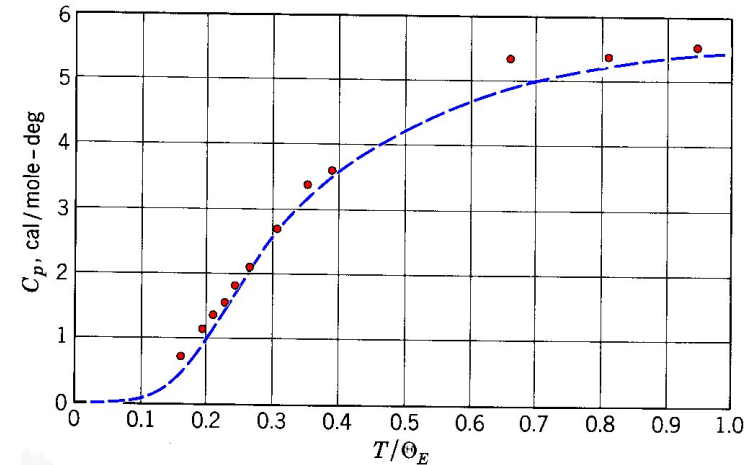

Comparison of experimental values of the heat capacity of diamond with values calculated on the Einstein model, using the characteristic temperature  $\Theta_E = \hbar\omega/k_B = 1320^\circ\text{K}$ . [After A. Einstein, Ann. Physik **22**, 180 (1907).]

- ▶ Einstein theory shows correct trends with temperature.
- ▶ For simple harmonic oscillator, spring constant  $\alpha$ , mass  $m$ ,  $\omega = \sqrt{\alpha/m}$ .
- ▶ So light, tightly-bonded materials (e.g. diamond) have high frequencies.

- ▶ But higher  $\omega \rightarrow$  lower specific heat.

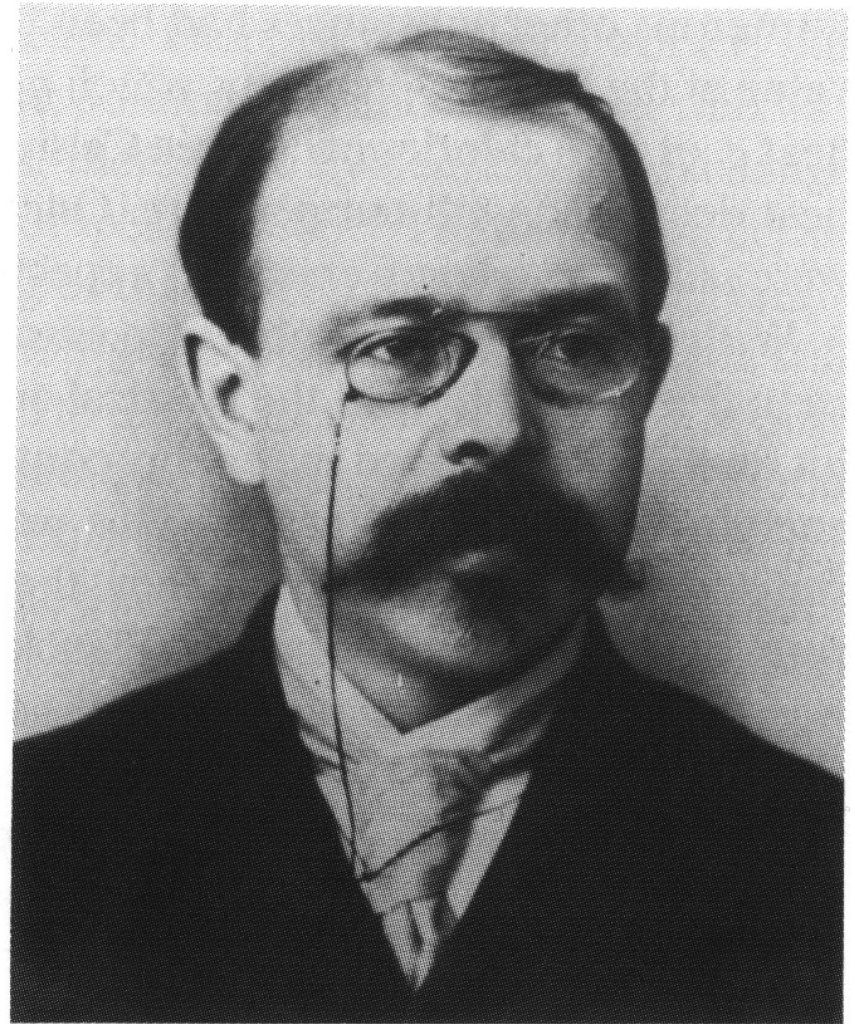

Walther Nernst (1864–1941)

- ▶ Hence Einstein theory explains low specific heats of some elements.
- ▶ Walther Nernst, working towards the Third Law of Thermodynamics (as we approach absolute zero the entropy change

in any process tends to zero), measured specific heats at very low temperature.

### 4.9 Debye Theory

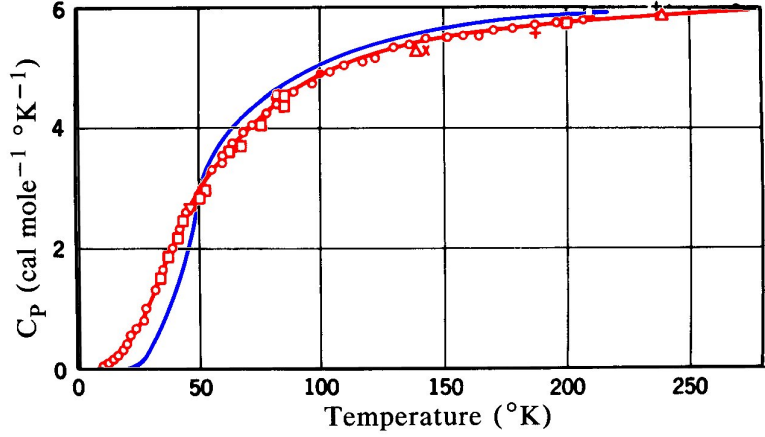

Specific heat data (points) for silver. The lines are the fits from the Einstein and Debye results. The Debye curve goes through the data points.

- ▶ Systematic deviations from Einstein model at low T.
- ▶ Nernst and Lindemann fitted data with two Einstein-like terms.
- ▶ Einstein realised that the oscillations of a solid were complex, far from single-frequency.
- ▶ Key point is that however low the temperature there are always some modes with low enough frequencies to be excited.



Peter Debye, 1884–1966.

- ▶ Based on classical elasticity theory (pre-dated the detailed theory of lattice dynamics).
- ▶ The assumptions of Debye theory are
  - ▷ the crystal is harmonic
  - ▷ elastic waves in the crystal are non-dispersive
  - ▷ the crystal is isotropic (no directional dependence)
  - ▷ there is a high-frequency cut-off  $\omega_D$  determined by the number of degrees of freedom

### 4.9.1 The Debye Frequency

- ▶ The cut-off  $\omega_D$  is, frankly, a fudge factor.
- ▶ If we use the correct dispersion relation, we get  $g(\omega)$  by integrating over the Brillouin zone, and we know the number of allowed values of  $k$  in the Brillouin zone is the number of unit cells in the crystal, so we automatically have the right number of degrees of freedom.
- ▶ In the Debye model, define a cutoff  $\omega_D$  by

$$N = \int_0^{\omega_D} g(\omega) d\omega,$$

where  $N$  is the number of unit cells in the crystal, and  $g(\omega)$  is the density of states in one phonon branch.

- ▶ Taking an average sound speed  $v$  we have for each mode

$$g(\omega) = \frac{V}{2\pi^2} \frac{\omega^2}{v^3},$$

so

$$\begin{aligned} N &= \int_0^{\omega_D} \frac{V}{2\pi^2} \frac{\omega^2}{v^3} d\omega \\ &= \frac{V}{6\pi^2} \frac{\omega_D^3}{v^3} \\ \omega_D^3 &= \frac{6N\pi^2}{V} v^3 \end{aligned}$$

Equivalent to Debye frequency  $\omega_D$  is  $\Theta_D = \hbar\omega_D/k_B$ , the Debye temperature.

### 4.9.2 Debye specific heat

- ▶ Combine the Debye density of states with the Bose-Einstein distribution, and account for the number of branches  $S$  of the phonon spectrum, to obtain

$$C_V = S \int_0^{\omega_D} \frac{V}{2\pi^2} \frac{\omega^2}{v^3} k_B \left( \frac{\hbar\omega}{k_B T} \right)^2 \frac{e^{\frac{\hbar\omega}{k_B T}}}{\left( e^{\frac{\hbar\omega}{k_B T}} - 1 \right)^2} d\omega.$$

- ▶ Simplify this by writing

$$x = \frac{\hbar\omega}{k_B T}, \quad \text{so} \quad \omega = \frac{k_B T x}{\hbar}, \quad x_D = \frac{\hbar\omega_D}{k_B T},$$

and

$$\begin{aligned} C_V &= S \int_0^{x_D} \frac{V}{2\pi^2} \frac{k_B^2 T^2 x^2}{\hbar^2 v^3} k_B x^2 \frac{e^x}{(e^x - 1)^2} \frac{k_B T}{\hbar} dx \\ &= S k_B \frac{V}{2\pi^2} \frac{k_B^3 T^3}{\hbar^3 v^3} \int_0^{x_D} \frac{x^4 e^x}{(e^x - 1)^2} dx \end{aligned}$$

► Remember that

$$\omega_D^3 = \frac{6N\pi^2}{V}v^3,$$

so

$$\frac{V}{2\pi^2v^3} = \frac{3N}{\omega_D^3} = \frac{3N\hbar^3}{k_B^3\Theta_D^3}$$

and

$$\begin{aligned} C_V &= Sk_B \frac{3N\hbar^3}{k_B^3\Theta_D^3} \frac{k_B^3T^3}{\hbar^3} \int_0^{x_D} \frac{x^4e^x}{(e^x-1)^2} dx, \\ &= 3NSk_B \frac{T^3}{\Theta_D^3} \int_0^{x_D} \frac{x^4e^x}{(e^x-1)^2} dx. \end{aligned}$$

► As with the Einstein model, there is only one parameter – in this case  $\Theta_D$ . Improvement over Einstein model.

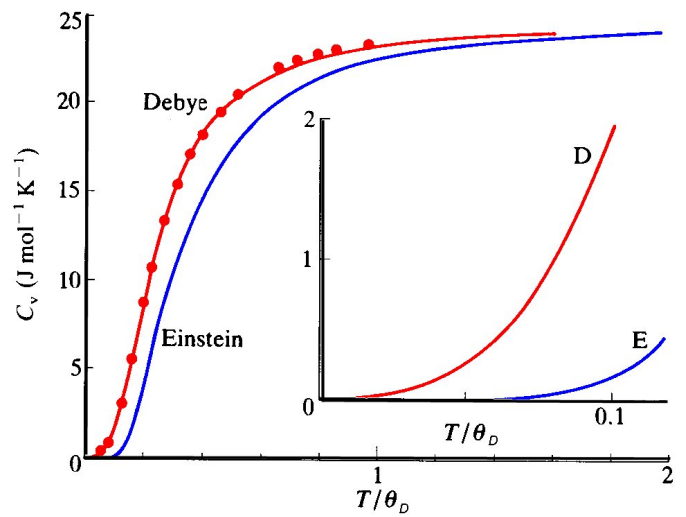

Debye and Einstein models compared with experimental data for Silver. Inset shows details of behaviour at low temperature.

### 4.9.3 Debye model: high T

$$C_V = 3NSk_B \frac{T^3}{\Theta_D^3} \int_0^{x_D} \frac{x^4e^x}{(e^x-1)^2} dx.$$

► At high T,  $x_D = \hbar\omega_D/k_B T$  is small. Thus we can expand the integrand for small  $x$ :

$$e^x \approx 1,$$

and

$$(e^x - 1) \approx x$$

so

$$\int_0^{x_D} \frac{x^4e^x}{(e^x-1)^2} dx \approx \int_0^{x_D} x^2 dx = \frac{x_D^3}{3}.$$

► The specific heat, then, is

$$C_V \approx 3NSk_B \frac{T^3}{\Theta_D^3} \frac{x_D^3}{3},$$

but

$$x_D = \frac{\hbar\omega_D}{k_B T} = \frac{\Theta_D}{T}$$

so

$$C_V \approx NSk_B.$$

- This is just the classical limit,  $3R = 3N_A k_B$  per mole.
- We should have expected this: as  $T \rightarrow \infty$ ,  $C_V \rightarrow k_B$  for each mode, and the Debye frequency was chosen to give the right total number of oscillators.

**4.9.4 Debye model: low T**

$$C_V = 3NSk_B \frac{T^3}{\Theta_D^3} \int_0^{x_D} \frac{x^4 e^x}{(e^x - 1)^2} dx.$$

► At low,  $x_D = \hbar\omega_D/k_B T$  is large. Thus we may let the upper limit of the integral tend to infinity.

$$\int_0^\infty \frac{x^4 e^x}{(e^x - 1)^2} dx = \frac{4\pi^4}{15}$$

so

$$C_V \approx 3NSk_B \frac{T^3}{\Theta_D^3} \frac{4\pi^4}{15}$$

► For a monatomic crystal in three dimensions  $S = 3$ , and  $N$ , the number of unit cells, is equal to the number of atoms.

► We can rewrite this as

$$C_V \approx 1944 \left( \frac{T}{\Theta_D} \right)^3$$

which is accurate for  $T < \Theta_D/10$ .

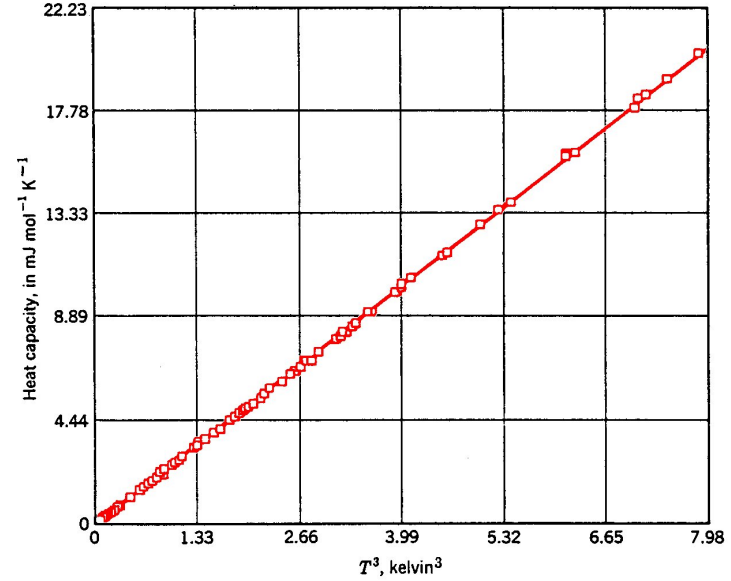

The low-temperature heat capacity of solid argon compared with the Debye  $T^3$  prediction with  $\Theta_D = 92$  K (solid line).

**4.9.5 Successes and shortcomings**

► Debye theory works well for a wide range of materials.



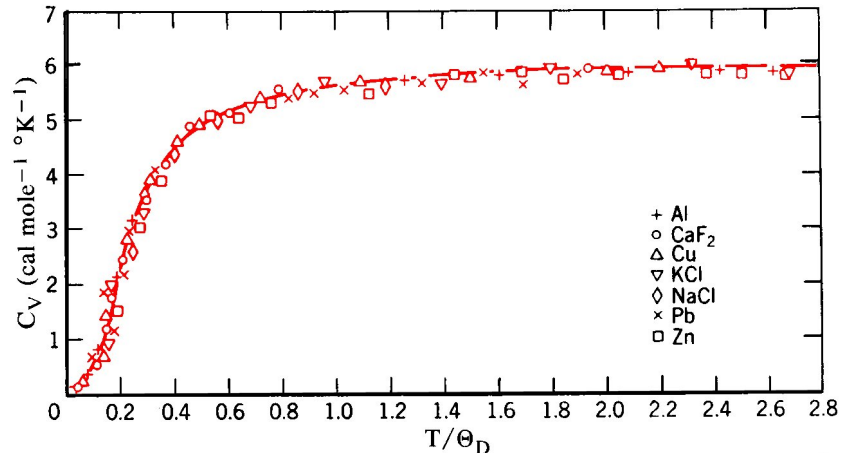

Heat capacity vs. reduced temperature for a number of materials.

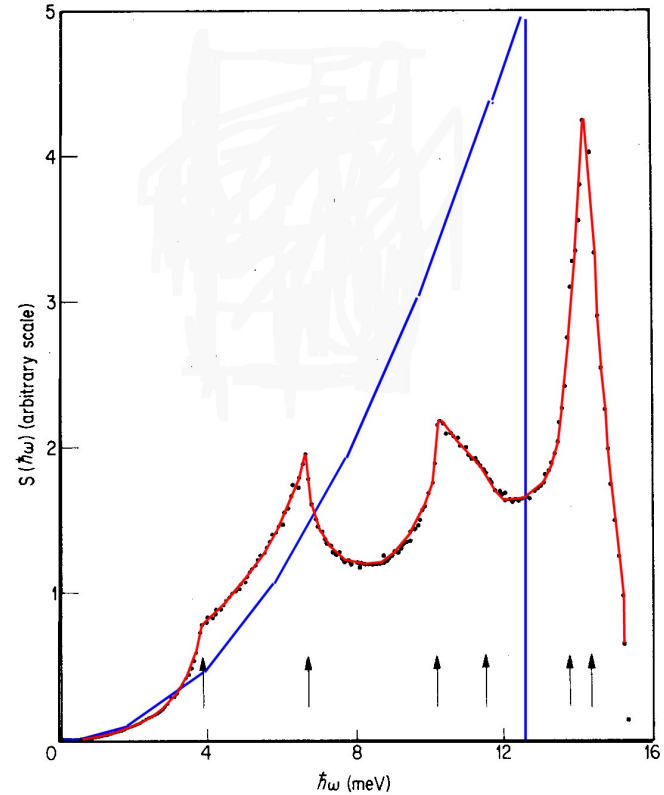

Density of modes in Na (after A. E. Dixon *et al.*, *Proc. Phys. Soc.* **81**, 973 (1963)).

- ▶ But we know it can't be perfect.
- ▶ Roughly: only excite oscillators at  $T$  for which  $\hbar\omega \leq k_B T$ .
- ▶ So we expect:
  - ▷ Very low  $T$ : OK

- ▷ Low T: real DOS has more low-frequency oscillators than Debye, so  $C_V$  higher than Debye approximation.
- ▷ High T: real DOS extends to higher  $\omega$  than Debye, so reaches classical limit more slowly.

## 4.10 Lattice Thermal Conductivity

► Use Debye temperature  $\Theta_D$  as a fitting parameter. Expect:

- ▷ Very low T: good result with  $\Theta_D$  from classical sound speed;
- ▷ Low T: rather lower  $\Theta_D$ ;
- ▷ High T: need higher  $\Theta_D$ .

### 4.10.1 Experimental values

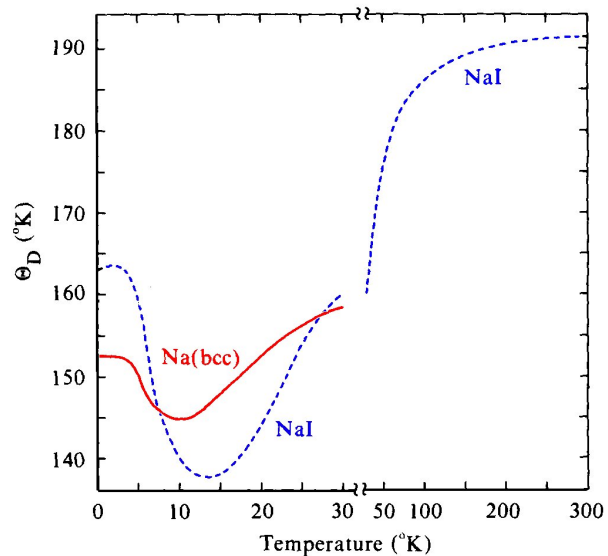

The temperature dependence of  $\Theta_D$  metallic sodium [J. D. Filby and D. L. Martin, Proc. Roy. Soc. (London) **276A**, 187 (1963).]  
 NaI [W. T. Berg and J. A. Morrison, Proc. Roy. Soc. (London) **242A**, 467 (1957)].

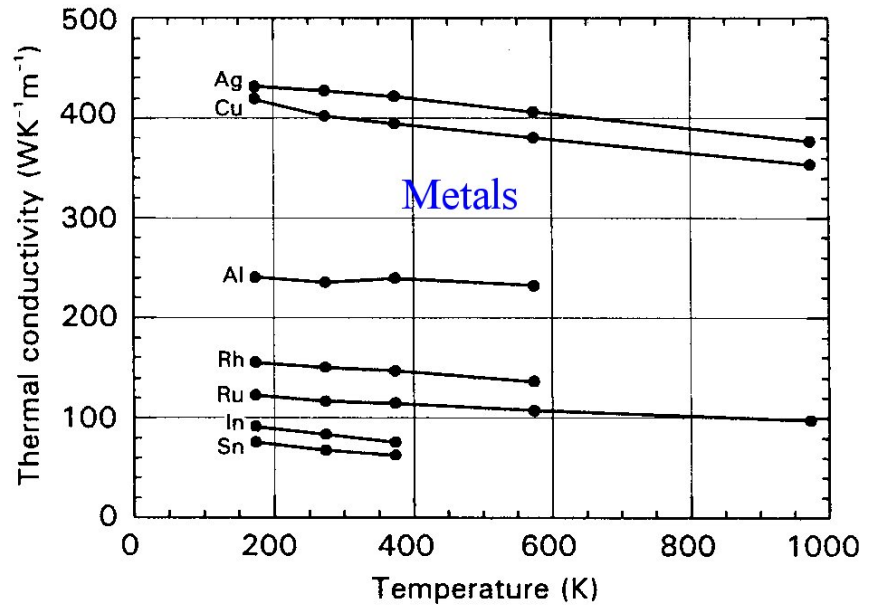

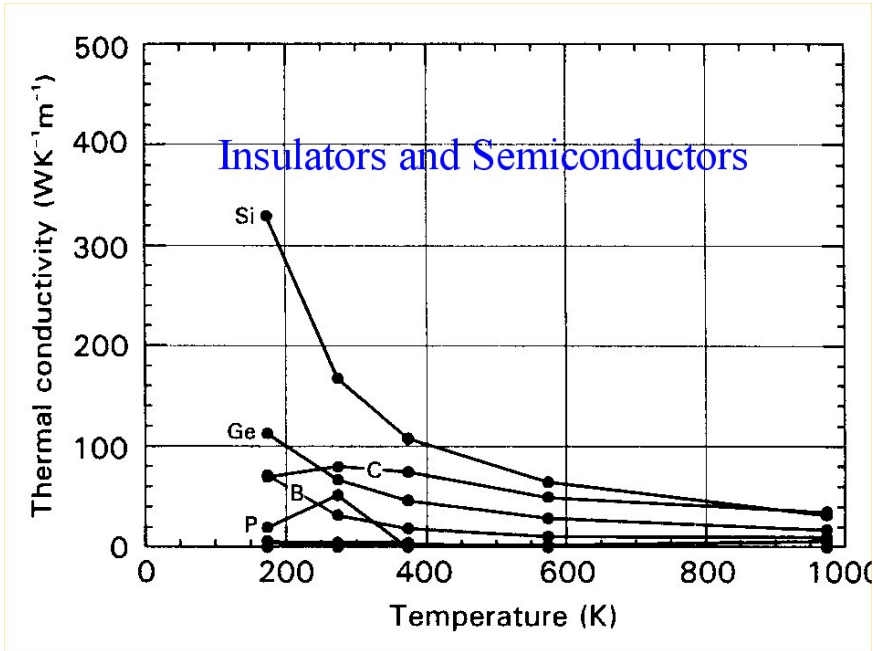

- ▶ Different behaviours of metals compared with insulators and semiconductors;
- ▶ Very large range of values: for elements at room  $T$ 
  - ▷ diamond: up to  $2600 \text{ W K}^{-1}\text{m}^{-1}$
  - ▷ copper:  $400 \text{ W K}^{-1}\text{m}^{-1}$
  - ▷ sulphur:  $0.3 \text{ W K}^{-1}\text{m}^{-1}$
- ▶ In the following sections we look at thermal conduction by lattice vibrations.

### 4.10.2 Phonons as particles

- ▶ If mode  $k$  is in its  $n_k$ th excited state, as the energy levels are equally spaced, we can regard this as a state with  $n_k$  identical excitations in mode  $k$ , each with energy  $\hbar\omega_k$ .
- ▶ We say there are  $n_k$  phonons in mode  $k$  (exact analogy with photons).
- ▶ The phonon has energy  $\hbar\omega_k$  and momentum  $\hbar k$ .
- ▶ We can think of the phonon as a particle (*quasiparticle*).

### 4.10.3 Phonon momentum

- ▶ The momentum of phonons is rather different to normal momentum.
- ▶ Conservation of momentum is a fundamental property of most systems: it is a result of the fact that the Hamiltonian of a free particle is invariant under translation ( $\mathbf{p}$  commutes with  $\mathcal{H}$ ).
- ▶ In a crystal, the Hamiltonian is only invariant under translation through a lattice vector  $\mathbf{R}$ .
- ▶ As a result, momentum in the crystal is only conserved to within an additive constant  $\hbar\mathbf{G}$ , where  $\mathbf{G}$  is a reciprocal lattice vector.
- ▶  $\hbar\mathbf{k}$  is not a true momentum of the whole crystal, except at  $\mathbf{k} = 0$  when it corresponds to uniform motion of the whole crystal.
- ▶  $\hbar\mathbf{k}$  is called *quasimomentum*.

**4.10.4 Phonon interactions**

- ▶ In the harmonic approximation we ignored terms in the Hamiltonian like

$$\sum_{nn'n''} u_n u_{n'} u_{n''} D_{nn'n''},$$

and got normal modes which did not interact.

- ▶ When we look for wave-like solutions, we have terms of the form

$$\sum_{kk'k''} \sum_n A_{kk'k''} \exp(i(\mathbf{k} + \mathbf{k}' + \mathbf{k}'') \cdot \mathbf{R}_n),$$

- ▶ As in our discussion of diffraction, the sum will be zero because of phase cancellation unless

$$(\mathbf{k} + \mathbf{k}' + \mathbf{k}'') \cdot \mathbf{R}_n = 2m\pi$$

where  $m$  is an integer.

- ▶ But if  $\mathbf{G}$  is a reciprocal lattice vector,  $\mathbf{G} \cdot \mathbf{R}_n$  is a multiple of  $2\pi$ , so all we can say is that

$$\mathbf{k} + \mathbf{k}' + \mathbf{k}'' + \mathbf{G} = 0.$$

- ▶ As a result of the anharmonic terms, we have phonon-phonon interactions.
- ▶ Physical explanation: a phonon alters the local atomic spacing, so that another phonon sees a difference in the crystal structure and is scattered by it.

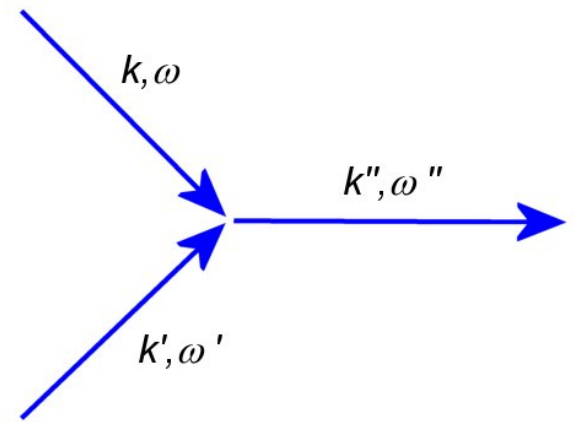

**4.10.5 Heat Transport**

- ▶ Treat phonons as a classical gas of particles, transporting energy  $\hbar\omega$  at velocity  $v$ , the group velocity of the waves.
- ▶ Hot regions have a higher density of phonons than cool regions.
- ▶ Heat flux (energy/area/time)  $\mathbf{Q}$ :

$$\mathbf{Q} = -\kappa \nabla T,$$

- ▶  $\kappa$  depends on
  - ▷ number of particles/volume carrying energy  $n$
  - ▷ specific heat per carrier  $c_V$

- ▷ carrier velocity  $v$
- ▷ how far carrier travels before being scattered (mean free path  $\Lambda$ )

► From kinetic theory of gases

$$\kappa = \frac{1}{3} n v c_V \Lambda.$$

- Note that  $n c_V$  is the specific heat *per volume*, as opposed to the specific heat *per mole* calculated earlier.
- Unless the phonons interact with something (are scattered) the thermal conductivity will be *infinite*.

**4.10.6 Boundary scattering**

- Clearly  $\Lambda$  is limited by the size of the specimen.
- Generally, the specimen is polycrystalline. in which case  $\Lambda$  is limited by the crystallite size.

**4.10.7 Point defect scattering**

- Any irregularity in the crystal will scatter a wave.
- An impurity, or even a different isotope, creates an irregularity.
- The defect size is about that of an atom.
- But at low temperatures only low-energy, long-wavelength phonons are excited.

► Scatterer size  $\ll \lambda$  is the condition for Rayleigh scattering  $\rightarrow \Lambda \propto \lambda^4$ .

► Dominant phonons at temperature  $T$  have  $k \propto T$ ,  $\lambda \propto T^{-1}$ , and at low  $T$  the number of phonons  $\propto T^3$  suggesting  $\kappa \propto T^3 \times T^{-4} = T^{-1}$ .

► More exact treatment

$$\kappa \propto T^{-\frac{3}{2}}.$$

**4.10.8 Phonon-phonon scattering**

► At first glance, expect phonon scattering to preserve thermal current, as energy and momentum are both conserved:

$$\begin{aligned} \mathbf{k}_1 + \mathbf{k}_2 &= \mathbf{k}_3 \\ \omega_1 + \omega_2 &= \omega_3 \end{aligned}$$

so even if phonons interact, they continue to carry the energy in the same direction.

► But remember that the dispersion relation is periodic – this makes a difference.

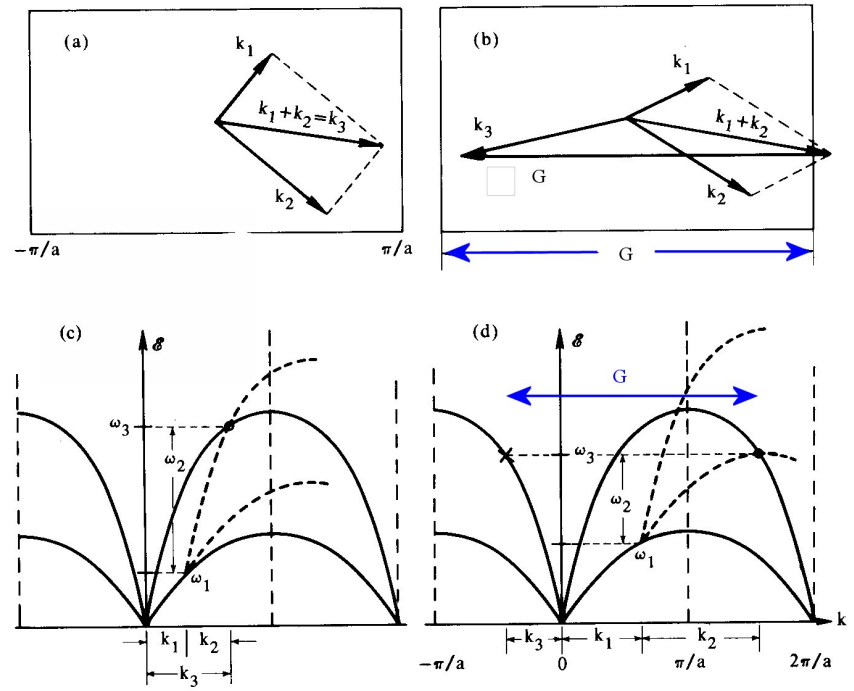

- ▶ If the two initial wavevectors add to a new wavevector which is outside the Brillouin zone, they give a new wave with a group velocity in the opposite direction.
- ▶ Usually, subtract  $G$ , a reciprocal lattice vector, to get back into the Brillouin zone:

$$\mathbf{k}_1 + \mathbf{k}_2 - \mathbf{G} = \mathbf{k}_3.$$

- ▶ Such a process is called an Umklapp process (German: flip-over) or *U-process*.
- ▶ Processes in which  $G = 0$  are called *N-processes*.

- ▶ Note that for a U-process at least one of the phonons must have  $|\mathbf{k}| > \pi/(2a)$ , so very rare at low  $T$ .
- ▶ At low  $T$ , assume number of phonons with large enough  $|\mathbf{k}|$  is  $\propto \exp(-\theta/T)$ , where  $\theta$  is a temperature comparable with the Debye temperature.
- ▶ At high  $T$ , most of the phonons will have large enough  $|\mathbf{k}|$  to give U-processes, and number of phonons  $\propto T$ .

### 4.10.9 Combined processes

- ▶ Assume all the scattering processes are independent.
- ▶ Each process acts independently to reduce the conductivity.
- ▶ Analogous to resistances in series, so

$$\text{total resistance} = \sum_{\text{processes } i} \text{resistance}_i$$

or

$$\kappa = \frac{1}{\sum_i \frac{1}{\kappa_i}}$$

- ▶ Look at temperature dependence of terms in

$$\kappa = \frac{1}{3} n v c_V \Lambda;$$

- ▶ Note that  $v$  has negligible  $T$  dependence.
- ▶ *High T*: can always have enough phonons for U-processes to dominate,

- ▷  $nc_V$  independent of  $T$  (classical limit)
- ▷  $\Lambda \propto T^{-1}$
- ▷  $\kappa \propto T^{-1}$

► *Very low  $T$* : U-processes are frozen out, and only have very long- $\lambda$  phonons so defect scattering small. Boundary scattering dominates:

- ▷  $nc_V \propto T^3$
- ▷  $\Lambda$  independent of  $T$  (geometry)
- ▷  $\kappa \propto T^3$

► *Low-intermediate  $T$ , isotopically pure* :U-processes dominate:

- ▷  $nc_V$  only weakly dependent on  $T$  compared with
- ▷  $\Lambda \propto \exp(\theta/T)$
- ▷  $\kappa \propto \exp(\theta/T)$

► *Low  $T$ , impure*: defect scattering dominates:

- ▷  $nc_V \propto T^3$
- ▷  $\Lambda \propto T^{-9/2}$
- ▷  $\kappa \propto T^{-3/2}$

► Schematic variation of  $\kappa$  with  $T$  for isotopically pure (left) or impure (right) material.

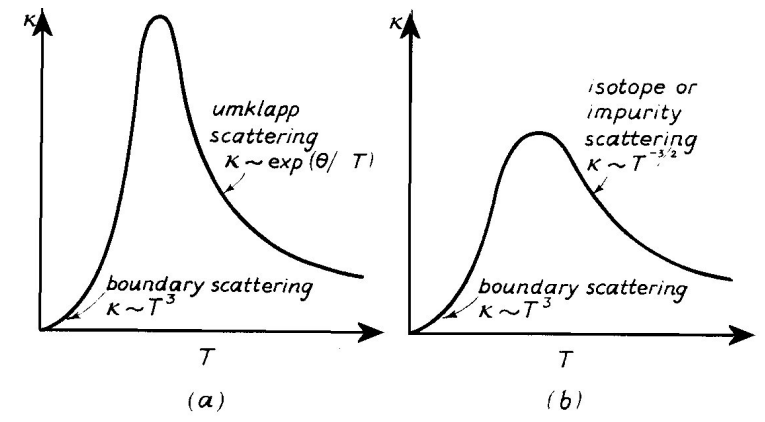

► Note steeper rise to higher peak value for pure material. Thermal conductivity of LiF as function of temperature for varying content of  $^6\text{Li}$  isotope.

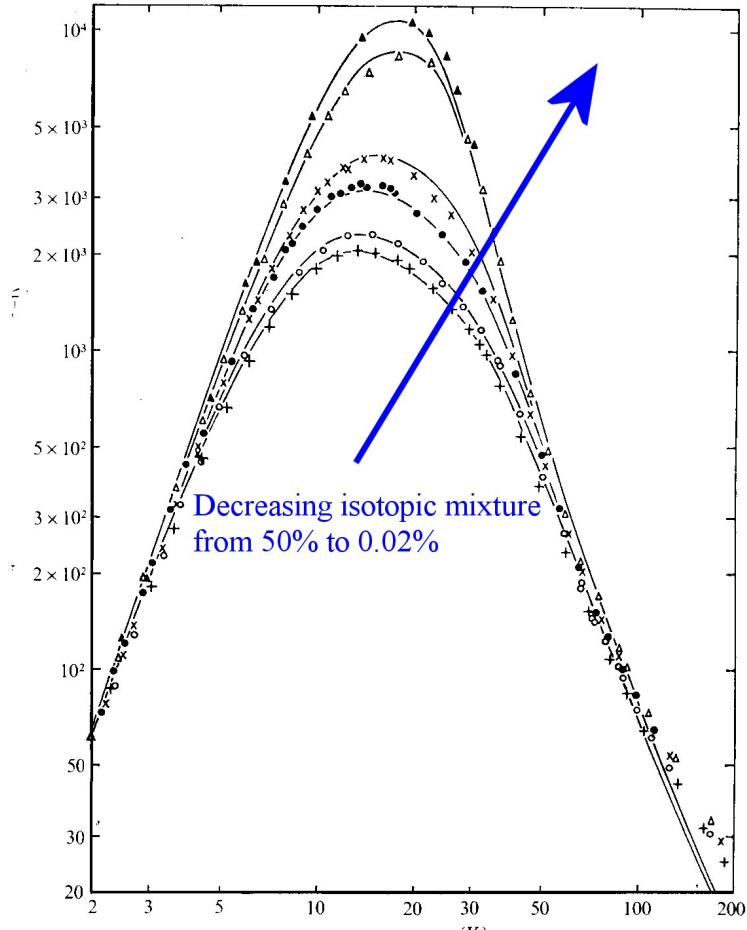

Decreasing isotopic mixture from 50% to 0.02%

- ▶ Defect content can be increased by irradiation (e.g. neutron damage in nuclear reactor).
- ▶ Thermal conductivity of LiF as function of specimen size at low temperature, showing effect of boundary scattering.

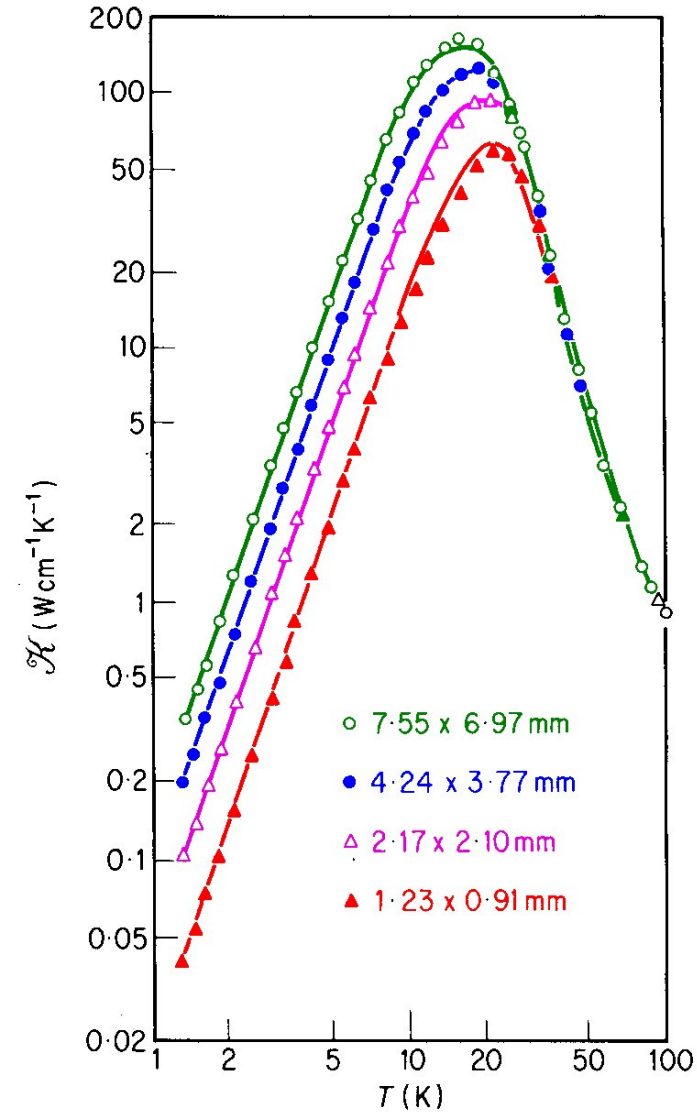

○ 7.55 x 6.97 mm  
 ● 4.24 x 3.77 mm  
 △ 2.17 x 2.10 mm  
 ▲ 1.23 x 0.91 mm

- ▶ Thermal conductivity of LiF plotted as  $\kappa/T^3$  as function of temperature for low temperature.



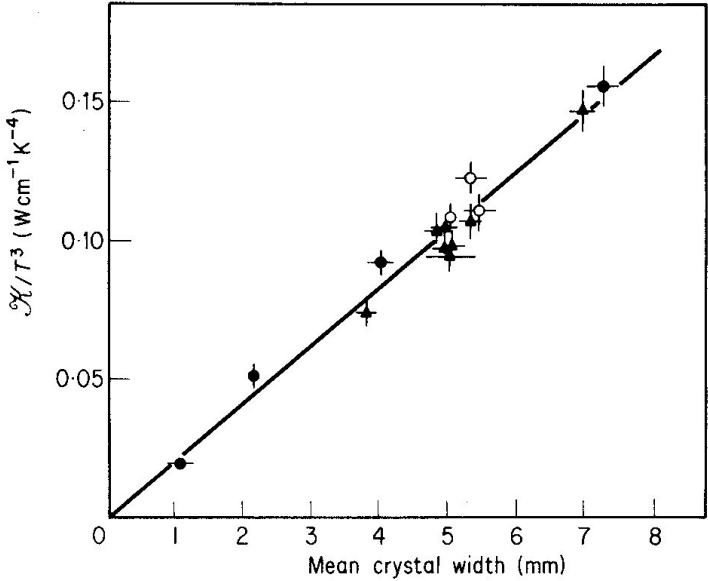

# Chapter 5

## Electrons in Solids - Overview

### 5.1 Experimental values

▷ *insulators* resistivities above  $10 \Omega\text{m}$ ;

#### 5.1.1 Electrical Resistivity

Element	Resistivity ( $\Omega\text{m}$ )	Element	Resistivity ( $\Omega\text{m}$ )
Lithium	$8.9 \times 10^{-8}$	Germanium	0.46
Sodium	$4.2 \times 10^{-8}$	Selenium	$10^{-2}$
Sodium	$4.2 \times 10^{-8}$	Silicon	$10^{-3}$
Copper	$1.7 \times 10^{-8}$	Tellurium	$4.4 \times 10^{-3}$
Silver	$1.6 \times 10^{-8}$		
Tin	$1.1 \times 10^{-7}$	Boron	$1.8 \times 10^4$
Barium	$5.0 \times 10^{-7}$	Phosphorus	$10^9$
Manganese	$1.9 \times 10^{-6}$	C (diamond)	$10^{11}$

▷ *superconductors* have unmeasurably small resistivities

► Divide materials into:

- ▷ *metals* resistivities between  $10^{-8}$  and  $10^{-5} \Omega\text{m}$ ;
- ▷ *semiconductors* resistivities between  $10^{-5}$  and  $10 \Omega\text{m}$ ;

► Note the enormous range of values. The temperature variations are also very different:

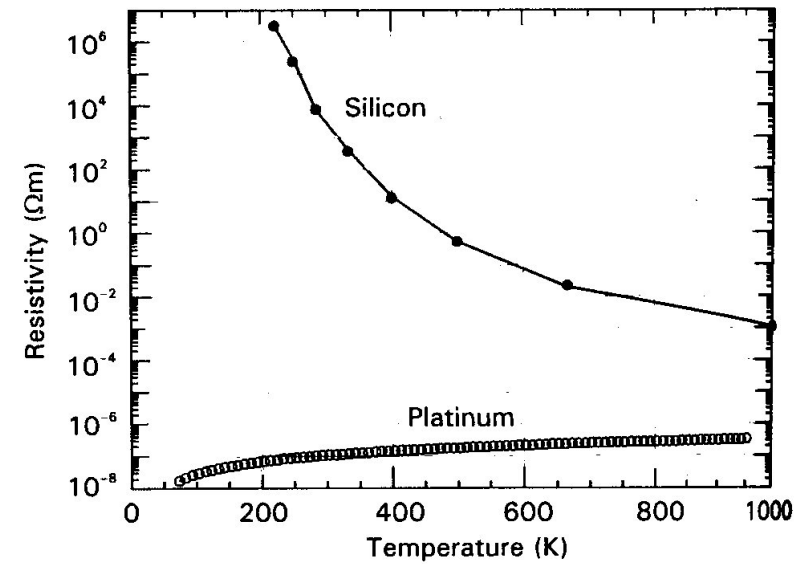
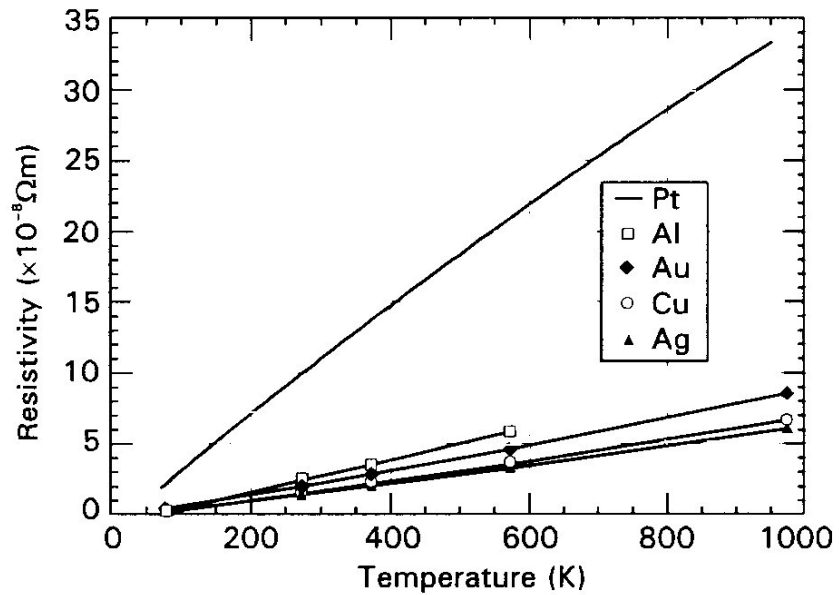

- Semiconductors (and insulators) have much stronger temperature dependence of  $\rho$  – and in the opposite direction with  $T$ .
- We might expect some sort of 'law of mixtures' for alloys, but

Resistivities at room $T$ in $\Omega m \times 10^8$		
Component1	Alloy	Component2
Cu	Cu(Zn)	Zn
1.55	6.3	5.5
Pt	Pt(10% Ir)	Ir
9.8	25	4.7
Pt	Pt(10% Rh)	Rh
9.8	19	4.3

► For most metals,  $\rho \propto T$ .

- ▶ Adding a trace of low-resistivity Ir to Pt has *increased* the Pt's resistivity.

**5.1.2 Magnetic properties**

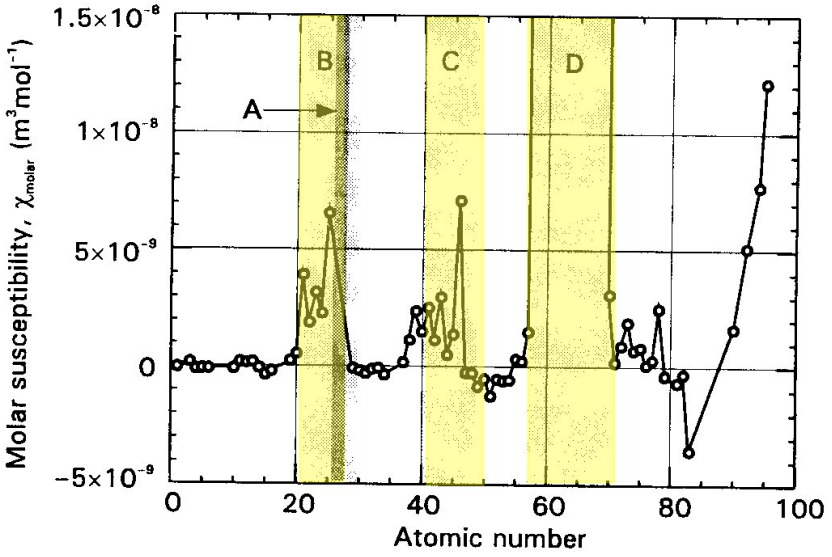

- ▶ Yellow regions are ferromagnetic
  - ▷ (A) Fe, Co, Ni
  - ▷ (B) First transition series
  - ▷ (C) Second transition series
  - ▷ (D) Lanthanides
- ▶ All elements with part-filled inner electron shells.
- ▶ We need to explain
  - ▷ *diamagnetism* which is always present;
  - ▷ *paramagnetism* seen in metals and other materials
  - ▷ *ferromagnetism*

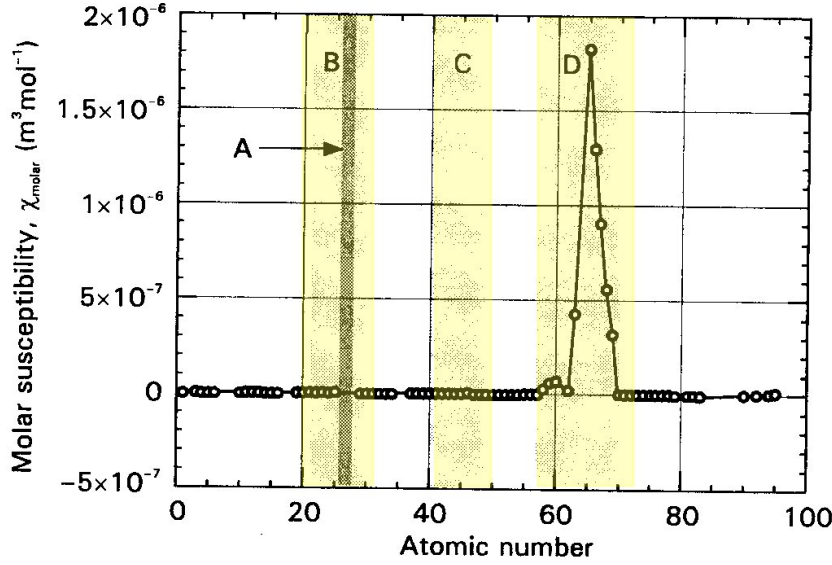

- ▷ magnetic effects on resistivity
- ▷ special magnetic properties (perfect diamagnetism) of superconductors

### 5.1.3 Miscellaneous properties

- ▶ Work function and contact potentials of metals
- ▶ Extra specific heat above  $3R$  per mole
- ▶ Optical properties
  - ▷ transparent – clear and coloured
  - ▷ opaque
  - ▷ metallic – silvery or coloured
- ▶ thermionic emission (electrons 'boil off')
- ▶ field emission
- ▶ high thermal conductivity of metals
- ▶ plasma frequency of metals
- ▶ x-ray spectra of solids
- ▶ thermoelectricity

## 5.2 Theory

- ▶ We are going to introduce the *band theory* of electrons in solids.
- ▶ Electrons in atoms occupy certain allowed levels:

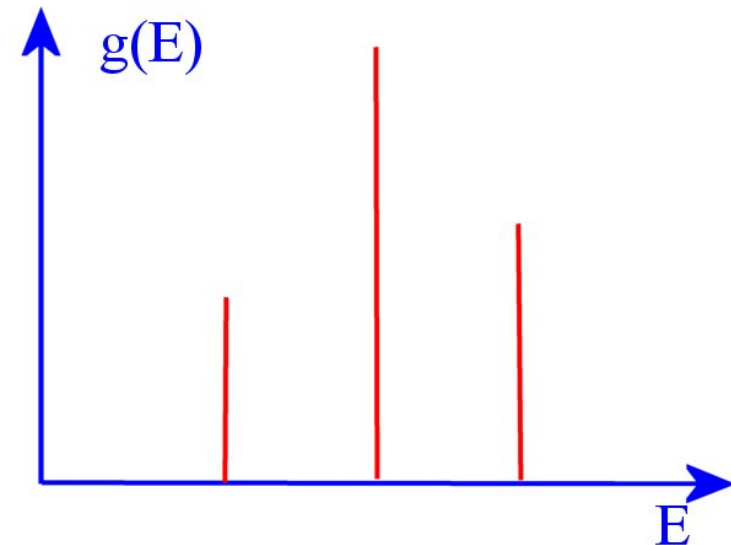

- ▶ Electrons in solids occupy *bands* of allowed states:

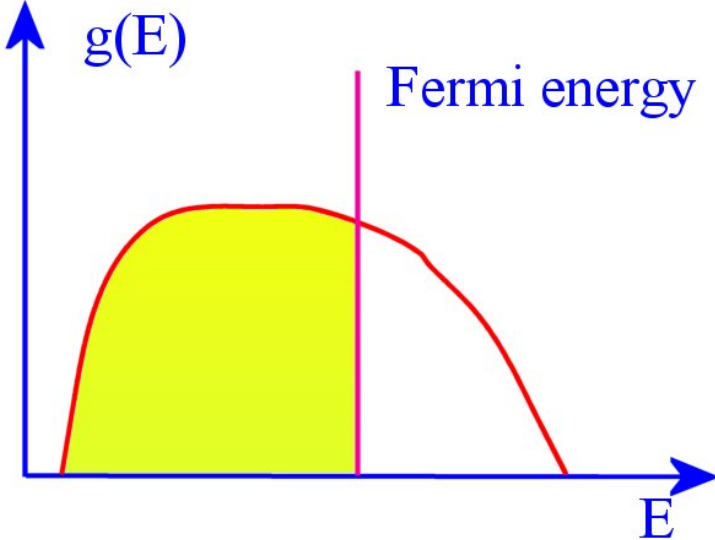
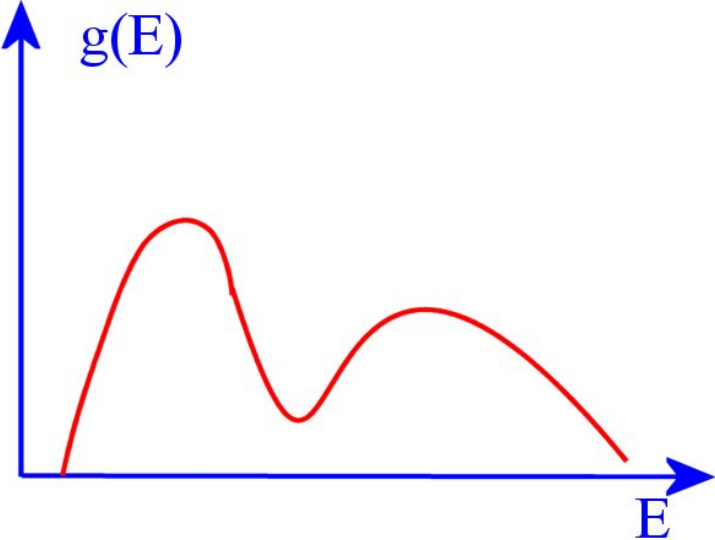

► In an insulator or semiconductor there is a gap.

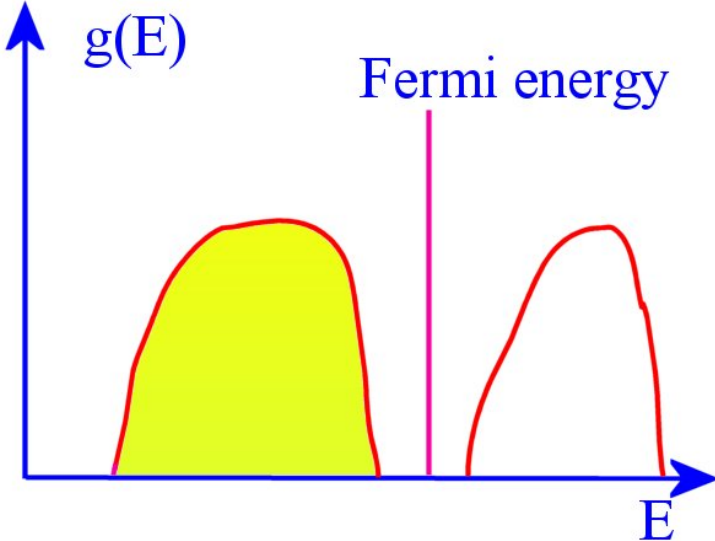

► In a metal there is no gap between the occupied and unoccupied states:

- ▶ Note that the distinction between metals and insulators/semiconductors is definite:
  - ▷ in metals there is no gap in the density of states at the Fermi energy at  $T = 0$
  - ▷ in the others there is
- ▶ The difference between semiconductors and insulators is quantitative, and depends on the *size* of the gap.
- ▶ Semiconductors have band gaps ranging up to 2 eV or less – insulators have larger gaps.
- ▶ Intuitively, it is obvious that we can 'do things to' the electrons, such as accelerate them, with little difficulty in a metal, but in semiconductors and insulators we have to promote them across the gap first.

# Chapter 6

## The Free Electron Model

### 6.1 Preliminaries

#### 6.1.1 Required Knowledge

- ▶ Quantum mechanics
- ▶ Thermodynamics
- ▶ Fermi-Dirac distribution
- ▶ Newton's laws
- ▶ Force on charge due to electric and magnetic fields

#### 6.1.2 Reading

- ▶ Hook and Hall 3.1-3.3

### 6.2 Basic Features

- ▶ In the free electron model, we assume that the valence electrons can be treated as free, or at least moving in a region of constant potential, and non-interacting.
- ▶ We'll examine the assumption of a constant potential first, and try to justify the neglect of interactions later.

#### 6.2.1 Constant Potential

- ▶ Imagine stripping the valence electrons from the atoms, and arranging the resulting ion cores on the atomic positions in the crystal.



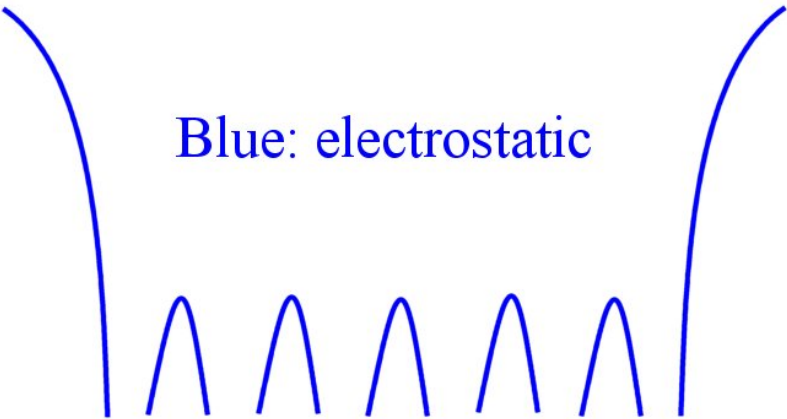

- ▶ Resulting potential – periodic array of Coulombic attractions.
- ▶ From atomic theory, we are used to the idea that different electronic functions must be orthogonal to each other (remember we used this idea in discussing the short-range repulsive part of interatomic potentials, and metallic bonding.)
- ▶ If  $\psi_c(\mathbf{r})$  is a core function and  $\psi_v(\mathbf{r})$  is a valence function

$$\int \psi_c(\mathbf{r})\psi_v(\mathbf{r})d\mathbf{r} = 0.$$

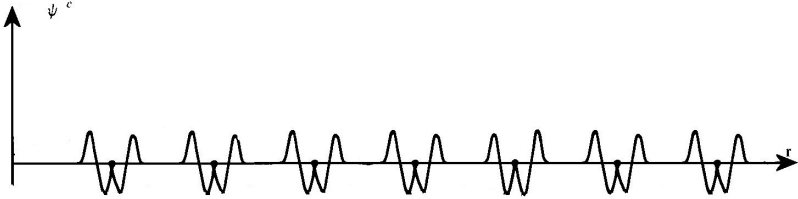

- ▶ Let's see how orthogonality might be achieved for a slowly-varying wave.

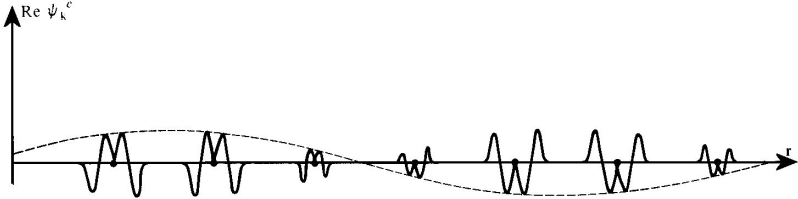

- ▶ To achieve orthogonality:

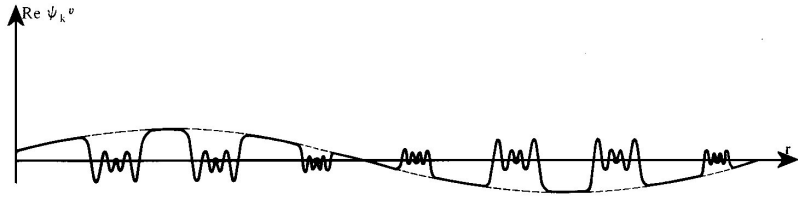

- ▶ We need high spatial frequency (large  $k$ ) components in the wave. Large  $k \rightarrow$  large energy. So the extra energy caused by the orthogonality partly cancels the Coulomb potential.
- ▶ This can be formalised in *pseudopotential theory* in which the potential is weakened and the constant potential assumption is a reasonable one.

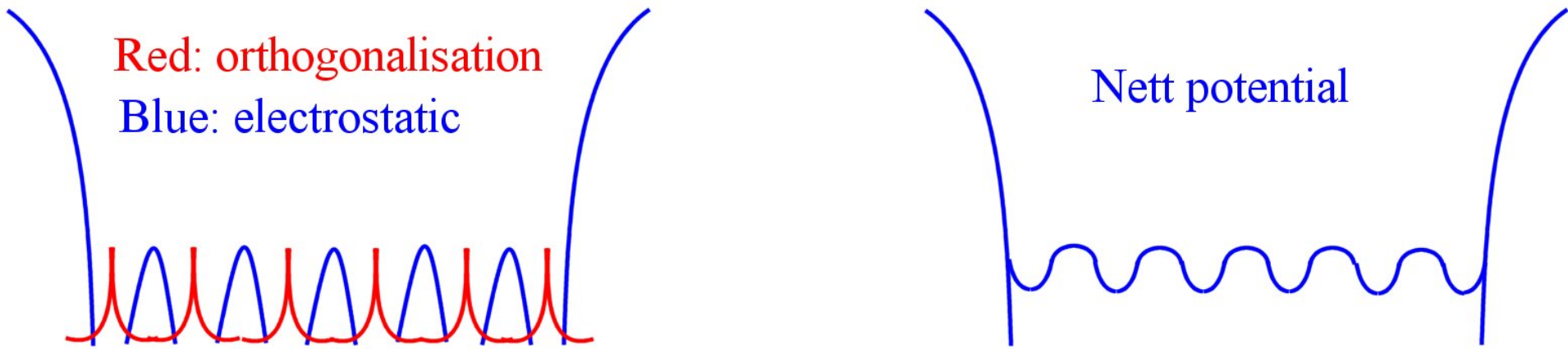

► The net result is that the effective potential seen by the electrons does not have very strong dependence on position.

► So finally we assume that the attractive potential of the ion cores can be represented by a flat-bottomed potential.

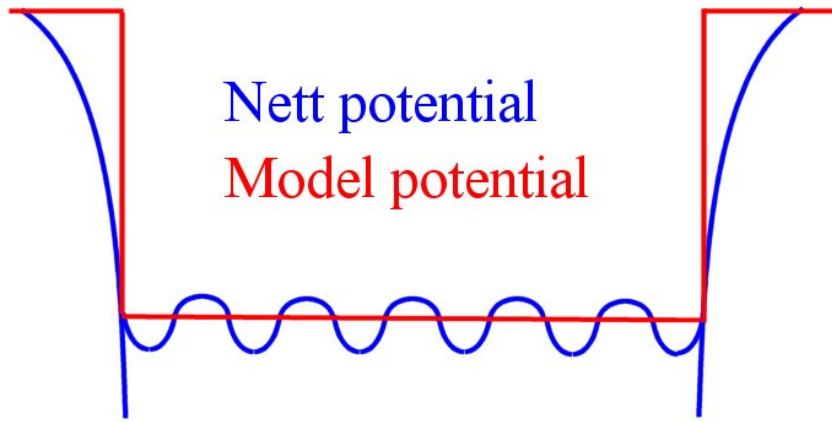

- ▶ We go further, and assume that the potential is deep enough that we can use a simple ‘particle-in-a-box’ model – the free electron model.

**6.2.2 Free Electron Fermi Gas**

- ▶ For the particle in a box with potential  $\mathcal{V}$ , Schroedinger’s equation gives

$$-\frac{\hbar^2}{2m} \nabla^2 \psi + \mathcal{V} \psi = E' \psi,$$

or, with a shift of origin for energy,  $E' - \mathcal{V} \rightarrow E$ ,

$$-\frac{\hbar^2}{2m} \nabla^2 \psi = E \psi,$$

so that the wavefunctions have the form

$$\psi_{\mathbf{k}}(\mathbf{r}) = \frac{1}{\sqrt{V}} \exp(i\mathbf{k} \cdot \mathbf{r}),$$

where  $V$  is the volume of the material.

- ▶ These are travelling waves, with energies

$$E_{\mathbf{k}} = \frac{\hbar^2 k^2}{2m},$$

dependent only on  $k = |\mathbf{k}|$ . That is,  $E_{\mathbf{k}}$  depends only on the *magnitude* of  $\mathbf{k}$ , not its direction.

- ▶ We can use the result (obtained in our discussion of the density of states of phonons) that the number of states with modulus of wavevector between  $k$  and  $k + dk$  is

$$g(k)dk = \frac{V}{8\pi^3} 4\pi k^2 dk = \frac{V}{2\pi^2} k^2 dk.$$

- ▶ For electrons

$$\frac{dE}{dk} = \frac{\hbar^2 k}{m} = \frac{\hbar^2}{m} \sqrt{\frac{2mE}{\hbar^2}} = \frac{\hbar}{\sqrt{m}} \sqrt{2E}.$$

- ▶ We also need to include a factor of 2 for spin up and spin down.

$$\begin{aligned}
g(E) &= 2g(k) \frac{dk}{dE} \\
&= 2 \frac{V}{2\pi^2} k^2 \frac{dk}{dE} \\
&= 2 \frac{V}{2\pi^2} \frac{2mE}{\hbar^2} \frac{\sqrt{m}}{\hbar\sqrt{2E}} \\
&= \frac{Vm}{\pi^2 \hbar^3} \sqrt{2mE}.
\end{aligned}$$

- Note that as  $V$  increases, so does the density of states.

### 6.2.3 The Fermi Energy

- At absolute zero the Fermi distribution function  $n(E)$

$$n(E) = \frac{1}{\exp((E - E_F)/k_B T) + 1}$$

is 1 up to the Fermi energy  $E_F$ , and 0 above that.

- Suppose the volume  $V$  contains  $N_e$  electrons. Then we know

$$\begin{aligned}
N_e &= \int_0^\infty g(E)n(E)dE \\
&= \int_0^{E_F} g(E)dE \\
&= \frac{V\sqrt{2m^3}}{\pi^2 \hbar^3} \int_0^{E_F} \sqrt{E} dE \\
&= \frac{V\sqrt{2m^3}}{\pi^2 \hbar^3} \frac{2E_F^{3/2}}{3}
\end{aligned}$$

so

$$E_F = \frac{\hbar^2}{2m} \left( \frac{3\pi^2 N_e}{V} \right)^{2/3}.$$

- We can define two related quantities:

- ▷ Fermi temperature,  $T_F$ ,

$$T_F = E_F/k_B.$$

- ▷ Fermi wavevector,  $k_F$ , the magnitude of the wavevector corresponding to,

$$E_F = \frac{\hbar^2 k_F^2}{2m}$$

so

$$k_F = \left( \frac{3\pi^2 N_e}{V} \right)^{1/3}.$$

### 6.2.4 Orders of magnitude

- For a typical solid, the interatomic spacing is about  $2.5 \times 10^{-10}$  m.
- Assume each atom is in a cube with that dimension, and that it releases one valence electron, giving an electron density  $N_e/V \approx 6 \times 10^{28} \text{ m}^{-3}$ .
- Putting in the numbers, we find
  - ▷  $E_F \approx 9 \times 10^{-19} \text{ J} = 6 \text{ eV}$
  - ▷  $T_F \approx 70,000 \text{ K}$

▷  $k_F \approx 1.2 \times 10^{10} \text{ m}^{-1}$ , comparable with the reciprocal lattice spacing  $0.4 \times 10^{10} \text{ m}^{-1}$  as

► We can also estimate the electron velocity at the Fermi energy:

$$v_F = \frac{\hbar k_F}{m} \approx 1.4 \times 10^6 \text{ m s}^{-1},$$

which is fast, but not relativistic.

► The total energy of the electrons is given by

$$\text{total energy of electrons} = \int_0^{E_F} E g(E) dE = \frac{3}{5} N_e E_F,$$

so that the average energy per electron is  $\frac{3}{5} E_F$ . Note that this consists entirely of *kinetic energy*.

► We can therefore write the average kinetic energy per electron

$$\begin{aligned} K_e &= \frac{3}{5} E_F \\ &= \frac{3\hbar^2}{10m} \left( \frac{3\pi^2 N_e}{V} \right)^{2/3} \\ &= \frac{3\hbar^2 (3\pi^2)^{2/3}}{10m} \rho^{2/3} \\ &= \frac{3\hbar^2 (3\pi^2)^{2/3}}{10m} \left( \frac{1}{\frac{4}{3}\pi r_s^3} \right)^{2/3} \\ &= \frac{\hbar^2}{2ma_0^2} \times \frac{3(9\pi/4)^{2/3}}{5} \times \frac{1}{(r_s/a_0)^2} \\ 1\text{Ry} &= \frac{\hbar^2}{2ma_0^2} \\ \Rightarrow \frac{K_e}{\text{Ry}} &\approx 2.210 \frac{1}{(r_s/a_0)^2} \end{aligned}$$

## 6.2.5 The Fermi surface

► In later sections we shall talk a good deal about the Fermi surface. This is a constant-energy surface in reciprocal space ( $\mathbf{k}$ -space) with energy corresponding to the Fermi energy.

► For the free electron gas, this is a sphere of radius  $k_F$ .

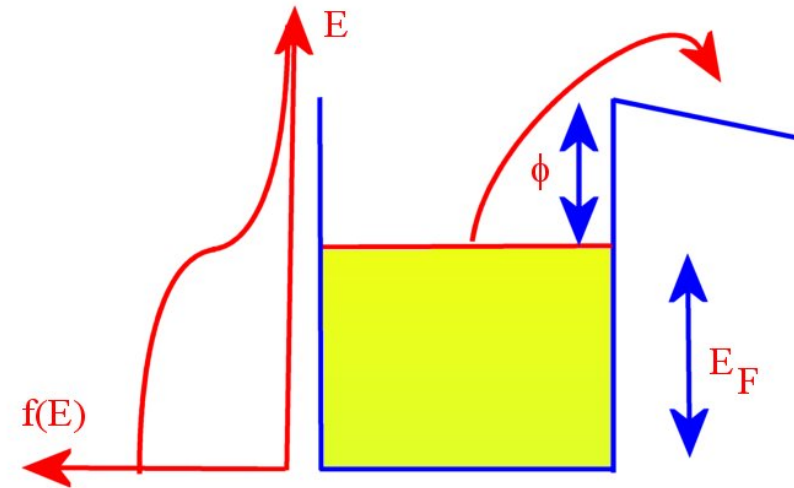
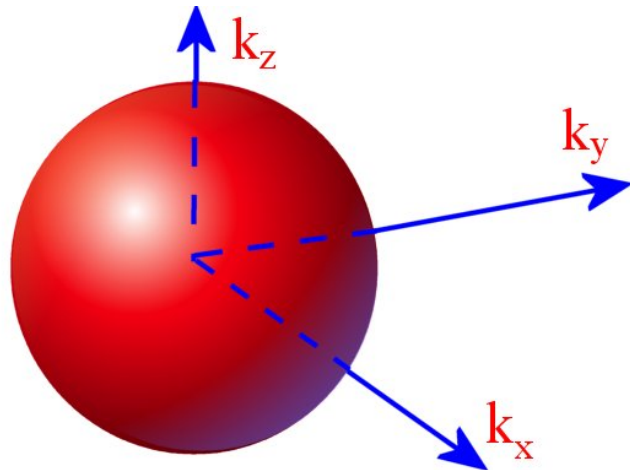

### 6.3 Some simple properties of the free electron gas

#### 6.3.1 Thermionic emission

- ▶ If the work function  $\phi$  is small enough, then when the material is heated the electrons may acquire enough thermal energy to escape the metal. A small electric field is used to draw them away.

- ▶ The current is given by

$$J = BT^2 \exp\left(-\frac{\phi}{k_B T}\right),$$

with a theoretical value

$$B = \frac{emk_B^2}{\pi\hbar^2} = 1.2 \times 10^6 \text{ A m}^{-2} \text{ K}^{-2}.$$

Experimentally the exponential dependence is confirmed, with similar values for  $B$ .

#### 6.3.2 Field emission

- ▶ A large applied field alters the potential outside the metal enough to allow electrons to tunnel out.

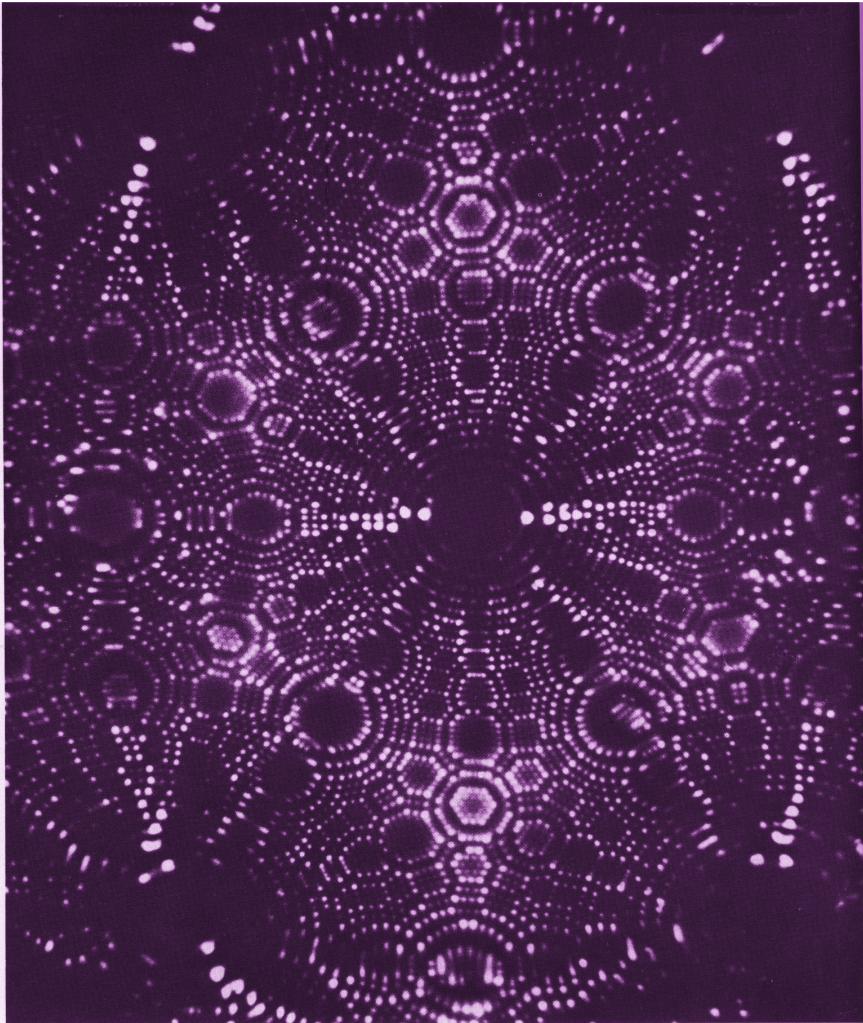
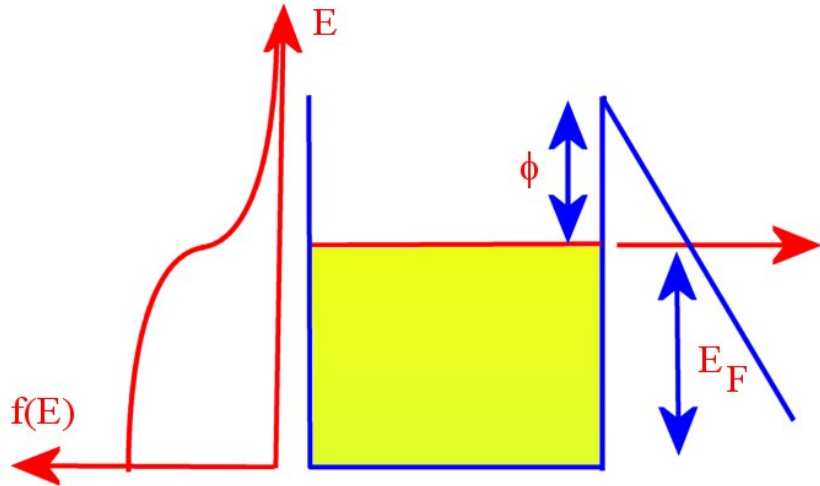

► Very large fields are needed, but a sharp metal tip can give an image which shows where the atoms are. Fields vary across the atoms.

► More detail is possible from newer scanning probe microscopes.

### 6.3.3 Photoemission

- ▶ A photon with energy greater than the work function can eject an electron from the metal.

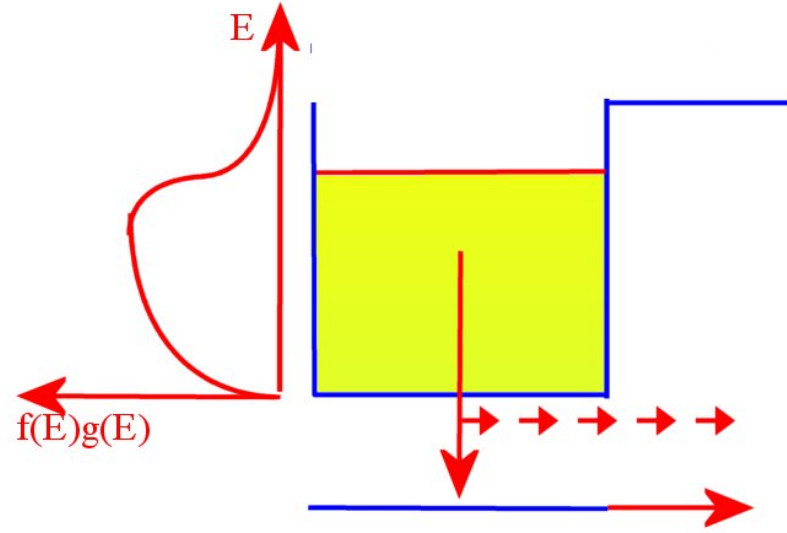
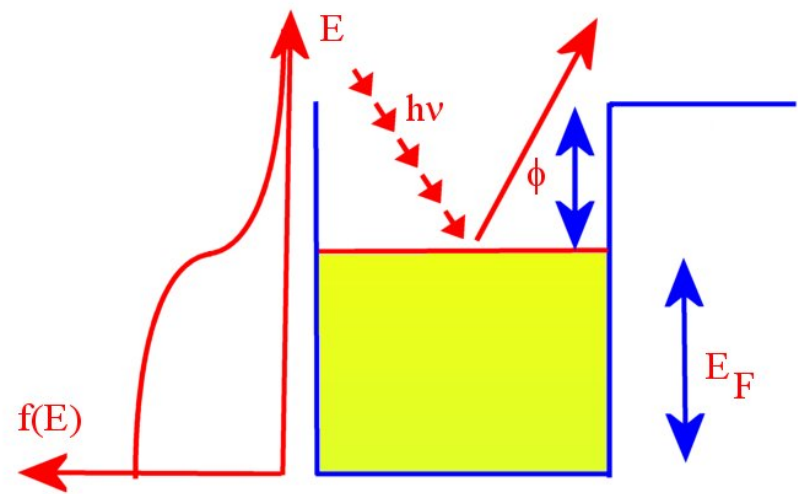

### 6.3.4 X-ray emission (Auger spectroscopy)

- ▶ A high-energy electron incident on a metal may knock out an electron from a core state (almost unchanged from the atomic state).
- ▶ An electron from the band can fall into the empty state, emitting an x-ray.

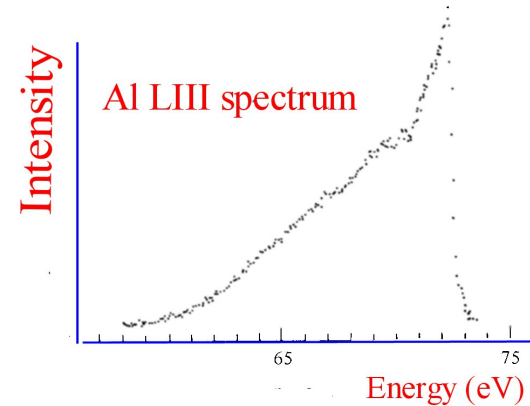

A typical soft X-ray spectrum for a simple metal. (After Aita and Sagawa (1969).)



### 6.3.5 Contact potential

- ▶ If two metals with different Fermi energies are brought into contact, electrons will move so as to equalize the Fermi levels.
- ▶ As a result, one becomes positively charged and the other negatively charged, creating a potential difference which prevents further electron flow.

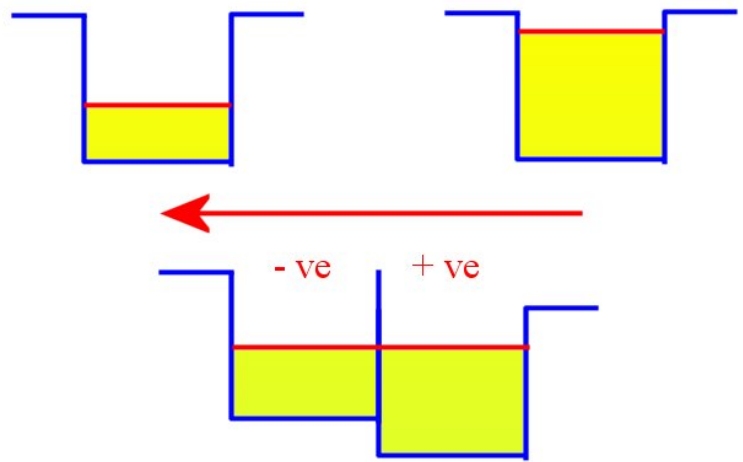

## 6.4 Thermal Behaviour of free electron gas

### 6.4.1 Review of Fermi function

- ▶ The key point about electrons in a metal is that the Fermi temperature  $T_F$  is *high* – about  $10^5$  K.

$$f_{FD} = \frac{1}{\exp((e - \mu)/k_B T) + 1}$$

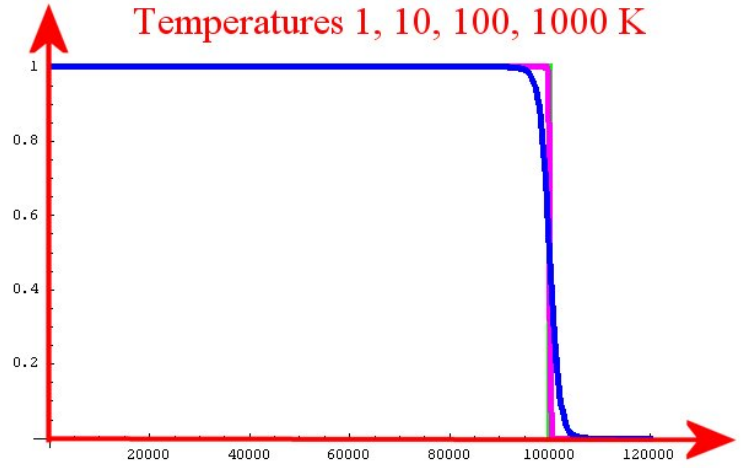

- ▶ Even if we zoom in, we can only just see the change from the step function at normal temperatures.

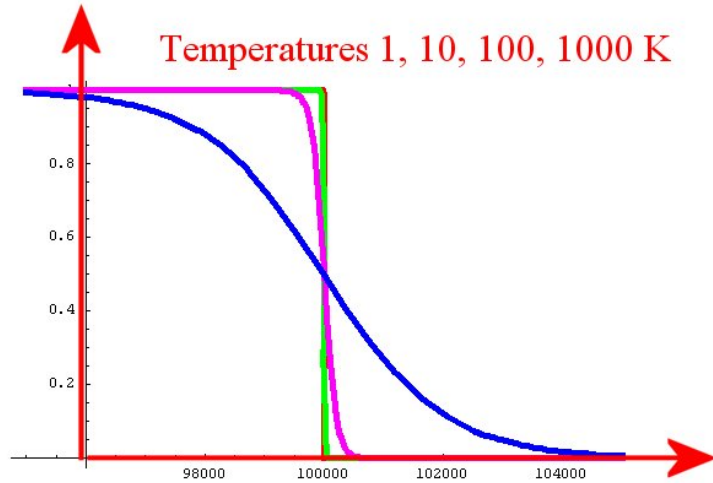

- This means that temperature has very little effect on the energy distribution of the electrons.

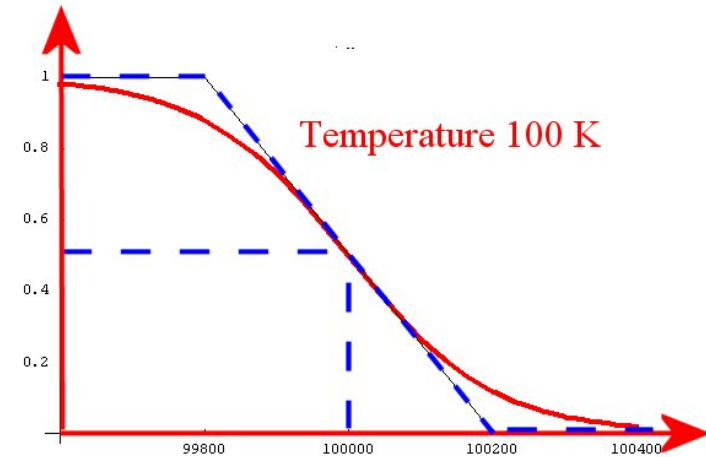

- Thus the effect of increasing temperature changes the energy of the number of electrons in a triangular region of height  $g(E_F)/2$  and width  $2k_B T$ , that is,  $\frac{1}{2}g(E_F)k_B T$ .
- These have their energy increased by about  $k_B T$  ( $\frac{4}{3}k_B T$  if we keep to the triangular model), so that

$$E_{\text{total}} \approx E_0 + \frac{1}{2}g(E_F)k_B T \times k_B T,$$

so that the electronic specific heat is

$$C_v = \frac{dE}{dT} \approx g(E_F)k_B^2 T.$$

### 6.4.2 Electronic specific heat

- To a good approximation, we can include the effect of temperature by drawing a straight line passing through  $f_{\text{FD}}(E_F) = \frac{1}{2}$ , falling from  $f_{\text{FD}}(E_F - 2k_B T) = 1$  to  $f_{\text{FD}}(E_F + 2k_B T) = 0$ .

► Note that

$$\begin{aligned}
 g(E_F) &= \frac{Vm}{\pi^2\hbar^3} \sqrt{2mE_F} \\
 &= V \frac{\sqrt{2m^3}}{\pi^2\hbar^3} \sqrt{E_F} \\
 E_F &= \frac{\hbar^2}{2m} \left( \frac{3\pi^2 N_e}{V} \right)^{2/3} \\
 &= \frac{1}{2m} \left( \frac{3\pi^2 \hbar^3 N_e}{V} \right)^{2/3} \\
 \pi^2 \hbar^3 &= \frac{V}{3N_e} (2mE_F)^{3/2} \\
 g(E_F) &= V \frac{3N_e}{V} \left( \frac{1}{2mE_F} \right)^{3/2} \sqrt{2m^3} \sqrt{E_F} \\
 &= \frac{3N_e}{2E_F}.
 \end{aligned}$$

so

$$C_v = \frac{3N_e k_B^2 T}{2E_F} = \left( \frac{k_B T}{E_F} \right) \times \frac{3}{2} N_e k_B$$

Thus quantum mechanics reduces the electronic heat capacity by a factor of  $k_B T/E_F$ .

► A more accurate evaluation gives

$$C_v = \frac{\pi^2}{3} g(E_F) k_B^2 T,$$

or

$$C_v = \frac{\pi^2 N_e k_B^2 T}{2E_F} = \frac{\pi^2}{3} \left( \frac{k_B T}{E_F} \right) \times \frac{3}{2} N_e k_B.$$

► If we take a typical  $E_F \approx 5$  eV then at 300 K  $C_v \approx 0.2 \text{ J K}^{-1} \text{ mol}^{-1}$ . This is less than one percent of the specific heat from vibrations ( $\approx 25 \text{ J K}^{-1} \text{ mol}^{-1}$ ).

### 6.4.3 Experimental results

► At low temperatures, though, the vibrational contribution falls off as  $T^3$ , so the vibrational and electronic parts become comparable.

► Conventionally write

$$C_v = \gamma T + AT^3$$

at low  $T$ , and so a plot of  $C_v/T$  against  $T^2$  should give a straight line.

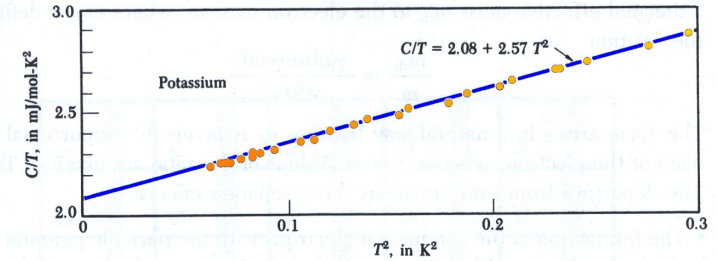

Experimental heat capacity values for potassium, plotted as  $C/T$  versus  $T^2$ .

► **Key point:** treating the electrons as quantum mechanical particles has shown their specific heat is reduced by a factor of about  $k_B T/E_F$  from the classical result.

## 6.5 Electrical Conductivity

### 6.5.1 Classical treatment

- ▶ A particle acted on by a force  $\mathcal{F}$  experiences a change in momentum

$$\mathcal{F} = \frac{d\mathbf{p}}{dt},$$

and for a classical particle

$$\mathcal{F} = m \frac{d\mathbf{v}}{dt}.$$

We know that the electrons in a metal have speeds ranging up to  $\approx 10^6 \text{ m s}^{-1}$ , in random directions, so that there is no nett movement of electrons in a particular direction.

- ▶ We assume that the force adds a *general tendency* for the electrons to move in the direction of the force. This is a property of *all* the electrons together.
- ▶ We call the associated velocity a *drift velocity*,  $v_d$ , and write

$$\mathcal{F} = m \frac{dv_d}{dt}.$$

- ▶ The electrons will move freely through a perfect crystal – but the perfection is disturbed by defects
  - ▷ impurities (not different isotopes – these affect phonons as they have different masses but not electrons as they are electrically identical)
  - ▷ dislocations

- ▷ grain boundaries
- ▷ phonons, locally altering the atomic spacings
- ▷ in addition, there may be electron-electron interactions

### 6.5.2 Relaxation time

- ▶ Introduce a *scattering time* or *relaxation time*  $\tau$ :
  - ▷ the probability of an electron being scattered in the time interval  $dt$  is  $dt/\tau$
  - ▷ at each scattering event the velocity is randomised – the drift velocity is reset to zero
  - ▷ so the rate at which  $v_d$  returns to zero is

$$\left( \frac{dv_d}{dt} \right)_{\text{scatter}} = -\frac{v_d}{\tau}$$

- ▶ We may have different scattering times  $\tau$  for different types of scattering – the different processes are assumed to be independent ( *Matthiessen's rule* )
- ▶ *Aside:* We can introduce a *mean free path*  $\Lambda$ . This is the distance *one* electron travels on average between collisions. The important electrons travel with the Fermi velocity  $v_F$  between collisions, so the distance travelled in the time  $\tau$  is

$$\Lambda = \tau v_F.$$

- ▶ So the evolution of  $v_d$  with time is

$$m \left[ \frac{dv_d}{dt} + \frac{v_d}{\tau} \right] = \mathcal{F}.$$

There are two important cases:

- ▶ *Steady state*: the time derivative is zero, so

$$m \frac{v_d}{\tau} = \mathcal{F},$$

$$v_d = \frac{\mathcal{F}\tau}{m}.$$

- ▶ *Zero force*: then

$$\frac{dv_d}{dt} + \frac{v_d}{\tau} = 0,$$

$$v_d(t) = v_d(0)e^{-t/\tau}$$

showing a *relaxation* of the drift velocity back to zero with a time constant  $\tau$ .

### 6.5.3 Electrical conductivity

- ▶ If the force arises from an electric field  $\mathcal{E}$  then

$$\mathcal{F} = -e\mathcal{E}$$

(note that  $e$  is the *magnitude* of the charge on the electron – hence the minus sign). So the steady-state drift velocity is

$$v_d = -\frac{e\mathcal{E}\tau}{m},$$

which is often expressed in terms of a *mobility*  $\mu$ ,

$$\begin{aligned} \mu &\equiv \text{drift speed in unit field} \\ &= |v_d/\mathcal{E}| \\ &= \frac{e\tau}{m} \end{aligned}$$

- ▶ Now the electrical current density  $\mathbf{J}$  is

$$\mathbf{J} = (\text{electron charge}) \times (\text{number of electrons/volume}) \times (\text{drift velocity})$$

- ▶ This gives us *Ohm's law*, current proportional to field. If we write  $n = N_e/V$ , we have

$$\begin{aligned} \mathbf{J} &= \sigma \mathcal{E} \\ \sigma &= \frac{ne^2\tau}{m} \\ &= ne\mu. \end{aligned}$$

### 6.5.4 Experimental results

- ▶ For our typical metal, with  $n \approx 6 \times 10^{28} \text{m}^{-3}$  and  $\sigma \approx 6 \times 10^7 \text{ }\Omega^{-1}\text{m}^{-1}$  this gives  $\tau \approx 3 \times 10^{-14} \text{ s}$ .

- ▶ Putting this together with the Fermi velocity  $v_F \approx 10^6 \text{ m s}^{-1}$  gives  $\Lambda \approx 3 \times 10^{-8} \text{ m}$  or about 100 interatomic distances.

- ▶ *Historical note*: Drude's theory of metals used a *classical* free electron model.

- ▶ This had electron speeds which were classically thermal ( $\frac{1}{2}mv^2 = \frac{3}{2}k_B T$ ), i.e. much slower than the  $v_F$  of the Fermi gas.

- ▶ Drude also assumed that the electrons would be scattered by every atom (i.e. his  $\Lambda$  was about 100 times too small).

- ▶ As a result of these cancelling errors, his estimate of the electrical conductivity was not too bad.

## 6.6 Electronic Thermal Conductivity

- ▶ We can use exactly the same expression as we used for phonons:

$$\kappa = \frac{1}{3}c_V v \Lambda,$$

only now  $c_V$  is the electronic specific heat per unit volume,  $v$  is the electron velocity, which we take as the Fermi velocity  $v_F$ , and  $\Lambda$  is the electronic mean free path,  $\Lambda = v_F \tau$ .

- ▶ We know that

$$c_V = \frac{\pi^2 n k_B^2 T}{2E_F},$$

(Note that we have converted from  $N_e$  to  $n = N_e/V$  to get specific heat per volume) and so

$$\kappa = \frac{1}{3} \frac{\pi^2 n k_B^2 T}{2E_F} v_F \times v_F \tau$$

But

$$E_F = \frac{1}{2} m v_F^2,$$

hence

$$\kappa = \frac{\pi^2 n k_B^2 T \tau}{3m}.$$

- ▶ If we take  $n = 6 \times 10^{28} \text{ m}^{-3}$  and  $\tau = 3 \times 10^{-14} \text{ s}$  we have at 300 K that  $\kappa = 370 \text{ W m}^{-1}\text{K}^{-1}$ .
- ▶ The measured thermal conductivity of Copper is  $400 \text{ W m}^{-1}\text{K}^{-1}$

- ▶ In pure metals, most of the thermal conductivity arises from the electrons.
- ▶ In impure metals (or random alloys, which amounts to the same thing) the vibrational contribution can be similar.

### 6.6.1 The Wiedemann-Franz law

- ▶ For metals at temperatures that are not very low, the ratio of thermal to electrical conductivity is directly proportional to temperature.

$$\frac{\kappa}{\sigma} = \frac{\pi^2 n k_B^2 T \tau / 3m}{n e^2 \tau / m} = \frac{\pi^2}{3} \left( \frac{k_B}{e} \right)^2 T.$$

- ▶ The constant of proportionality is called the *Lorenz number*:

$$L = \frac{\kappa}{\sigma T} = \frac{\pi^2}{3} \left( \frac{k_B}{e} \right)^2 = 2.45 \times 10^{-8} \text{ W } \Omega \text{ K}^{-2}.$$

- ▶ Experimental Lorenz numbers:

Element	$L \times 10^8 \text{ W } \Omega \text{ K}^{-2}$		Element	$L \times 10^8 \text{ W } \Omega \text{ K}^{-2}$	
	$L$ at 273 K	$L$ at 373 K		$L$ at 273 K	$L$ at 373 K
Ag	2.31	2.37	Pb	2.47	2.56
Au	2.35	2.40	Pt	2.51	2.60
Cd	2.42	2.43	Sn	2.52	2.40
Cu	2.23	2.33	W	3.04	3.20
Mo	2.61	2.79	Zn	2.31	2.33

- ▶ A temperature-independent Lorenz number depends on the relaxation processes for electrical and thermal conductivity being the same – which is not true at all temperatures.

## 6.7 Conductivity – the view from reciprocal space

### 6.7.1 Electrical conductivity

► The effect of a force  $\mathcal{F}$  is to alter the momentum,  $\hbar\mathbf{k}$ . We can ask what this will do to the Fermi sphere.

► For every electron

$$\frac{d\mathbf{k}}{dt} = \frac{\mathcal{F}}{\hbar},$$

so the Fermi sphere is displaced sideways.

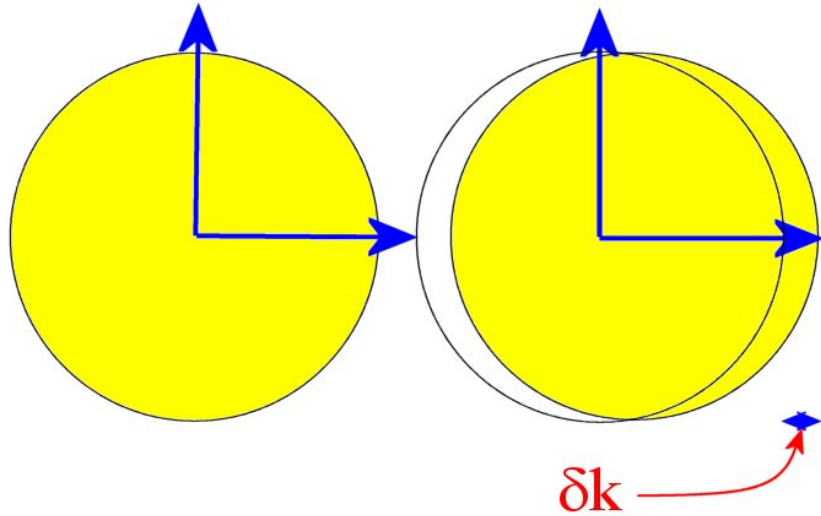

► Note that there is a *nett flow* of electrons.

► If the field acts for a time  $\tau$

$$\delta k = \mathbf{k}(\tau) - \mathbf{k}(0) = \frac{\mathcal{F}\tau}{\hbar} = -\frac{e\mathcal{E}\tau}{\hbar},$$

► If  $\mathcal{E} = 1000 \text{ V m}^{-1}$  and  $\tau = 10^{-14} \text{ s}$  then

$$\delta k = \frac{1.6 \times 10^{-19} \times 1000 \times 10^{-14}}{1.05 \times 10^{-34}} \approx 10^4 \text{ m}^{-1} \approx 10^{-6} k_F,$$

and the alteration in the Fermi surface is small.

### 6.7.2 Thermal conductivity

► There is no nett electric current – but electrons travelling in one direction have on average higher energy than those travelling in the opposite direction.

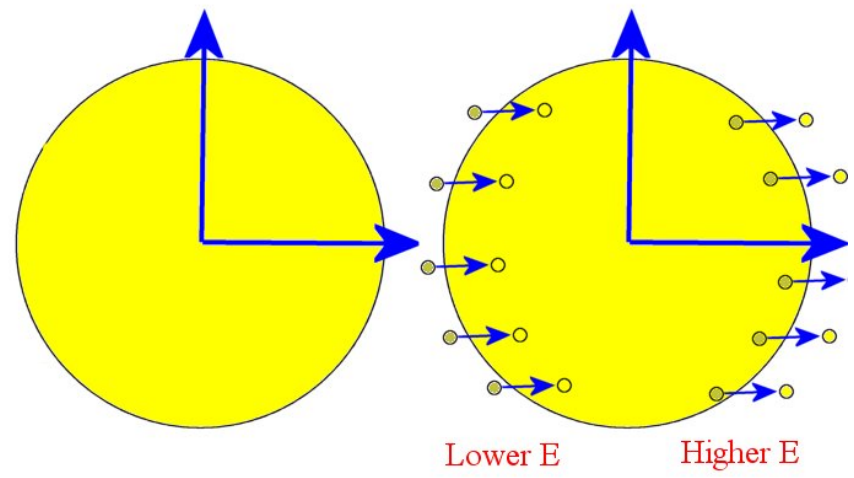

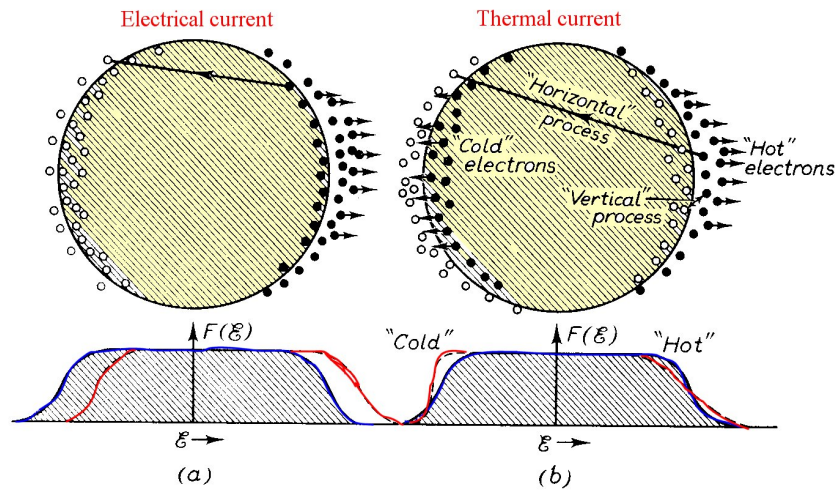

► The scattering processes are different:

- ▷ to reduce electric current requires large change in wavevector – phonon contribution falls off quickly at low  $T$ .
- ▷ to reduce thermal current requires change in thermal energy – by definition, energy  $\approx k_B T$

**6.7.3 Contributions to scattering**

- *Impurities* contribution independent of temperature.
- *Electron-phonon* scattering is temperature dependent
  - ▷ High  $T$ : plenty of large- $k$  phonons, so effect on  $\sigma$  and  $\kappa$  similar
    - ▷ number of phonons  $E/E_{phonon} = 3Nk_B T/k_B \Theta_D \propto T$  so  $\Lambda \propto 1/T$

- ▷  $c_V \propto T$
- ▷  $\sigma \propto 1/T, \kappa$  independent of  $T$
- ▷ Low  $T$ : few large- $k$  phonons, so phonons less effective at limiting  $\sigma$  than  $\kappa$ 
  - ▷ number of phonons  $E/E_{phonon} = const \times T^4/k_B T \propto T^3$  so  $\Lambda \propto 1/T^3$  for  $\kappa$
  - ▷ number of large- $k$  phonons  $\propto \exp(-\theta/T)$  so  $\Lambda \propto \exp(\theta/T)$  for  $\sigma$
  - ▷  $c_V \propto T$
  - ▷  $\sigma \propto \exp(\theta/T), \kappa \propto T^{-2}$
- ▷ Very low  $T$ : very few phonons, so impurities dominate
  - ▷  $c_V \propto T$
  - ▷  $\sigma$  independent of  $T, \kappa \propto T$

► As we saw before, different processes give resistances in series:

$$\rho = \sum_i \rho_i.$$

► Resistivity of potassium - different purities.



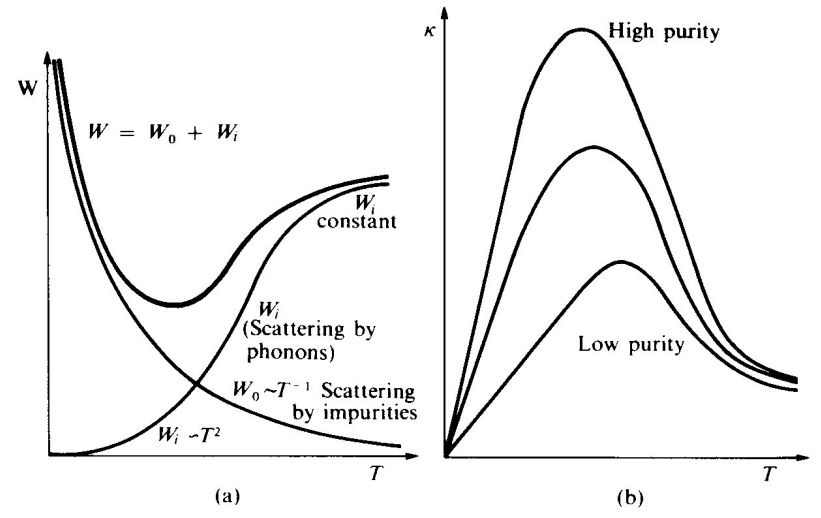
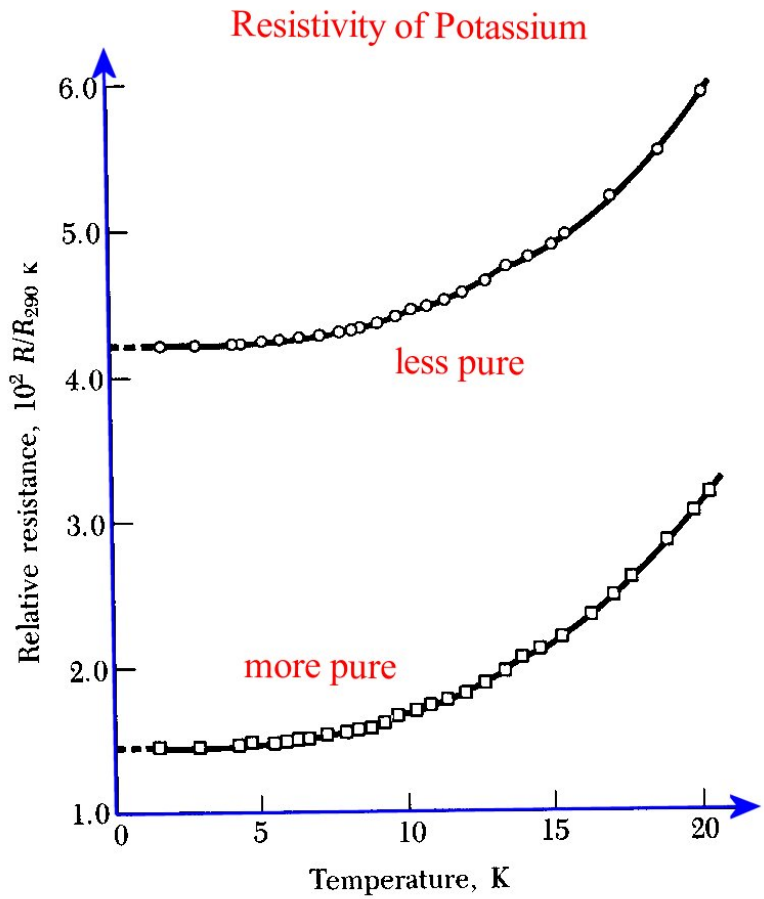

► Note that this means the Lorenz number  $L = \kappa/(\sigma T)$  is not constant with temperature.

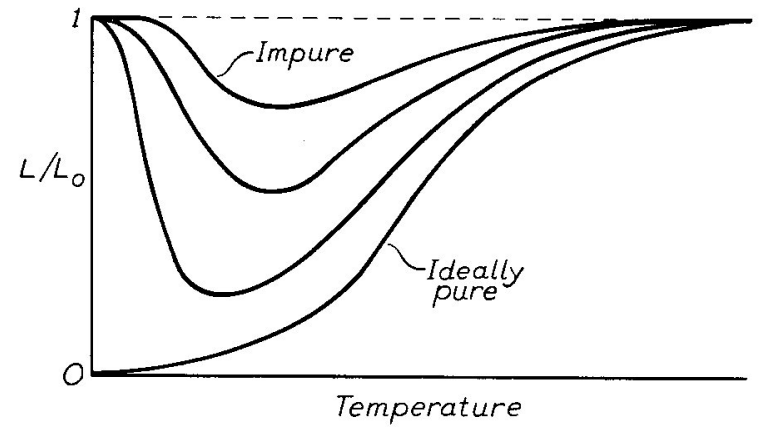

► Schematic variation of thermal resistance (a), thermal conductivity (b) with  $T$  at low  $T$ .

## 6.8 Plasma Oscillations

- ▶ The picture of a free electron gas and a positive charge background offers the possibility of *plasma oscillations* – a collective motion of all the electrons relative to the background.

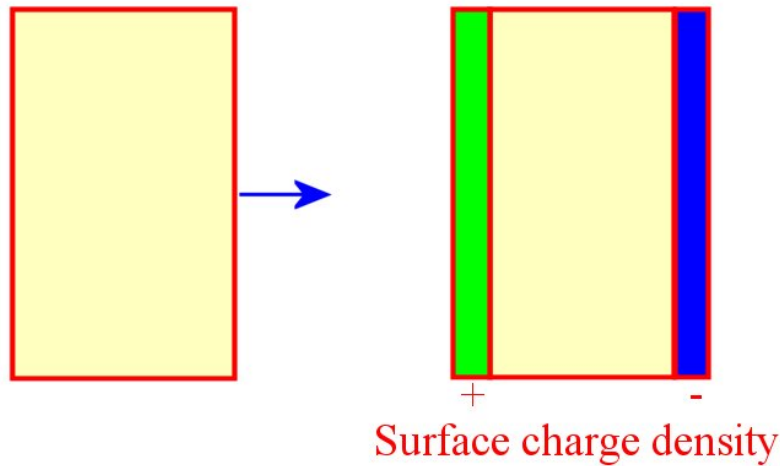

- ▶ If electron gas,  $n$  electrons per volume, moves a distance  $x$  relative to the positive background, this gives a surface charge density

$$\sigma = -enx$$

on the positive  $x$  side.

- ▶ But this gives an electric field

$$\mathcal{E} = -\frac{\sigma}{\epsilon_0},$$

which tries to restore the electrons to their equilibrium position by exerting a force

$$\mathcal{F} = -e\mathcal{E} = -\frac{ne^2}{\epsilon_0}x$$

on each electron.

- ▶ So

$$m\ddot{x} = -\frac{ne^2}{\epsilon_0}x$$

is a simple harmonic oscillator with angular frequency  $\omega_P$

$$\omega_P^2 = \frac{ne^2}{\epsilon_0 m}.$$

- ▶ For example, if  $n = 6 \times 10^{28} \text{ m}^{-3}$

$$\omega_P = \sqrt{\frac{ne^2}{\epsilon_0 m}} = \sqrt{\frac{6 \times 10^{28} \times (1.6 \times 10^{-19})^2}{8.854 \times 10^{-12} \times 9.11 \times 10^{-31}}} = 1.4 \times 10^{16} \text{ rad s}^{-1}.$$

This corresponds to an energy  $\hbar\omega_P = 8.9 \text{ eV}$ .

- ▶ If high energy (1 to 10 keV) electrons are fired through a metal film, they can lose energy by exciting plasma oscillations, or *plasmons*.

Volume plasmon energies, eV		
Metal	Measured	Calculated
Li	7.12	8.02
Na	5.71	5.95
K	3.72	4.29
Mg	10.6	10.9
Al	15.3	15.8

- ▶ Another success for free electron theory!

## 6.9 The Hall Effect

- ▶ In a Hall experiment a magnetic field applied perpendicular to an electric current flowing along a bar.

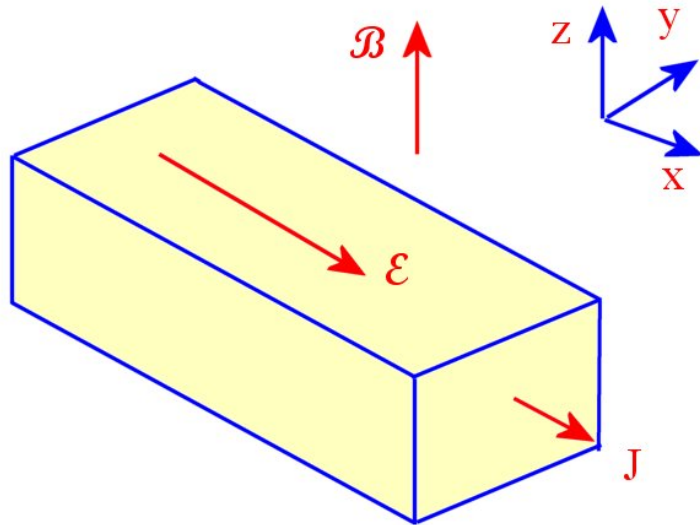

- ▶ We need to extend our previous equation by including the Lorentz force  $q\mathbf{v} \times \mathcal{B}$ .
- ▶ *Note:* Signs always cause problems in the Hall effect: avoid some confusion by writing  $q$  for the charge on the particles carrying the current –  $q$  includes the sign.

- ▶ The new transport equation is

$$m \left( \frac{d\mathbf{v}_d}{dt} + \frac{\mathbf{v}_d}{\tau} \right) = q(\mathcal{E} + \mathbf{v}_d \times \mathcal{B}).$$

- ▶ Assume that  $\mathcal{B} = (0, 0, \mathcal{B}_z)$  and  $\mathcal{E} = (\mathcal{E}_x, \mathcal{E}_y, \mathcal{E}_z)$  so

$$\begin{aligned} m \frac{dv_{dx}}{dt} + m \frac{v_{dx}}{\tau} &= q\mathcal{E}_x + qv_{dy}\mathcal{B}_z, \\ m \frac{dv_{dy}}{dt} + m \frac{v_{dy}}{\tau} &= q\mathcal{E}_y - qv_{dx}\mathcal{B}_z, \\ m \frac{dv_{dz}}{dt} + m \frac{v_{dz}}{\tau} &= q\mathcal{E}_z. \end{aligned}$$

- ▶ Now we know that current can only flow in the  $x$  direction, so  $v_{dy} = v_{dz} = 0$ , and so in a steady state

$$\begin{aligned} m \frac{v_{dx}}{\tau} &= q\mathcal{E}_x, \\ 0 &= q\mathcal{E}_y - qv_{dx}\mathcal{B}_z, \\ 0 &= q\mathcal{E}_z. \end{aligned}$$

- ▶ The first equation is one we have seen before:

$$v_{dx} = \frac{q\tau}{m} \mathcal{E}_x,$$

giving the current along the bar.

- ▶ The second equation states that an electric field is set up in the  $y$  direction:

$$\mathcal{E}_y = v_{dx}\mathcal{B}_z.$$

- ▶ The third equation states that there is no electric field in the  $z$  direction.
- ▶ Physically what happens is that the charges are accelerated in the  $y$  direction by the magnetic field, and pile up on the edges of the bar until they produce enough of an electric field to oppose the effect of the magnetic field.
- ▶ We know that the current density  $J_x$  in the  $x$  direction is

$$J_x = nqv_{dx},$$

so

$$\mathcal{E}_y = \frac{J_x \mathcal{B}_z}{nq},$$

- ▶ We define the Hall coefficient as

$$R_H = \frac{\mathcal{E}_y}{J_x \mathcal{B}_z}.$$

- ▶ For a free electron metal with  $n$  electrons per volume, then,  $R_H$  is negative,

$$R_H = -\frac{1}{ne}.$$

- ▶ Note that measuring Hall effects in metals is *difficult*: even with high current density ( $10^6 \text{ Am}^{-2}$ ) and magnetic fields of order 1 T we have to measure fields

$$\mathcal{E}_y = \frac{10^6 \times 1}{6 \times 10^{28} \times 1.6 \times 10^{-19}} = 0.0001 \text{ V m}^{-1},$$

or a potential difference of less than  $1 \mu\text{V}$  on a typically-sized sample.

Metal	Valence	$R_H^{\text{theor}}/R_H^{\text{exp}}$
Li	1	0.8
Na	1	1.2
K	1	1.1
Rb	1	1.0
Cs	1	0.9
Cu	1	1.5
Ag	1	1.3
Au	1	1.5
Be	2	-0.2
Cd	2	-1.2
Zn	3	-0.8
Al	3	-0.3

- ▶ Alkali metals OK.
- ▶ Noble metals numerically incorrect
- ▶ Higher-valent metals *wrong sign*. Major problem for free-electron theory!
- ▶ In addition,  $R_H$  depends on  $\mathcal{B}$  and  $T$ .

## 6.10 Free electron approximation – final comments

- ▶ We have still not explained how we can justify the assumption that electrons, charged particles, do not interact with one another.
- ▶ There are two effects: electrostatic screening and the exclusion principle.

### 6.10.1 Screening

- ▶ If the electrons are free to move, they arrange themselves so as to make the metal locally neutral
- ▶ But if they try to pack together more densely this will increase their energy because  $E_F$ , the energy relative to the local potential, increases with  $n = N_e/V$ .
- ▶ As a result, the electrostatic potential round a point charge  $q$  in a free electron gas is not

$$\mathcal{V}_0(r) = \frac{q}{4\pi\epsilon_0 r},$$

but

$$\mathcal{V}(r) = \frac{qe^{-r/\lambda}}{4\pi\epsilon_0 r},$$

a *screened Coulomb potential*, with

$$\lambda = \sqrt{\frac{2\epsilon_0 E_F}{3e^2 n}} \approx 6 \times 10^{-11} \text{ m}$$

for our usual set of parameters, so that electric fields inside a metal are screened out within a few interatomic spacings.

### 6.10.2 Electron-electron scattering

- ▶ At absolute zero, scattering *cannot* occur, because of the exclusion principle:
  - ▷ The two electrons are initially both in occupied states inside the Fermi surface.

- ▷ To conserve energy and momentum, either both final states lie inside the Fermi surface – but those states are all occupied – or one lies outside – but then the other lies inside.
- ▶ At finite  $T$  there is a layer of partly occupied states near  $E_F$ , amounting to a fraction about  $k_B T/E_F$  of the electrons, giving weak scattering with probability  $\propto T^2$ .
- ▶ See contribution to electrical resistivity  $\propto T^2$  in very pure metals at very low  $T$ .

### 6.10.3 Binding energy of metals

- ▶ The terms in the energy are:
  - ▷ Electronic kinetic energy (reduced by allowing them to be delocalised)
  - ▷ Attraction of electrons to ion cores (less than in free atoms as electrons are further from nuclei)
  - ▷ Mutual repulsion of ion cores (screened by the free electron gas)
  - ▷ Electron-electron repulsion (reduced by spreading out electrons)
  - ▷ Quantum mechanical exchange potential between electrons
  - ▷ Correlation energy (beyond single-electron wavefunctions)
- ▶ Balance of effects – typically a few eV per atom.

# Chapter 7

## Electrons in Periodic Structures

### 7.1 Preliminaries

#### 7.1.1 Required Knowledge

- ▶ Quantum mechanics
- ▶ Fourier series

#### 7.1.2 Reading

- ▶ Hook and Hall 4.1-4.2, 13.1-13.2

### 7.2 Introduction

- ▶ So far we have *completely* ignored the details of the potential seen by the electrons.
- ▶ The key point is that this is a *periodic* potential. Two consequences:

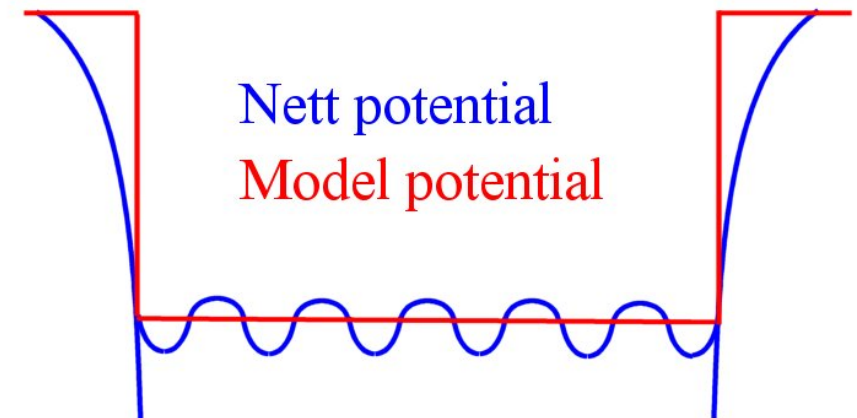

- ▷ restricts the form of the wavefunction;
- ▷ suggests Fourier analysis might be useful.

## 7.3 Bloch's theorem

- ▶ The Schrödinger equation is

$$-\frac{\hbar^2}{2m}\nabla^2\psi(\mathbf{r}) + V(\mathbf{r})\psi(\mathbf{r}) = E\psi(\mathbf{r}),$$

with

$$V(\mathbf{r} + \mathbf{R}) = V(\mathbf{r})$$

where  $\mathbf{R}$  is a lattice vector.

- ▶ Also, the probability density for the electrons must be a periodic function, so that it is the same in every unit cell, so

$$|\psi(\mathbf{r} + \mathbf{R})|^2 = |\psi(\mathbf{r})|^2$$

from which it follows that  $\psi$  only varies by a phase factor from cell to cell:

$$\psi(\mathbf{r} + \mathbf{R}) = e^{i\phi}\psi(\mathbf{r}).$$

- ▶ Take a one-dimensional example: if the lattice spacing is  $a$

$$\psi(x + a) = e^{i\phi}\psi(x),$$

so

$$\psi(x + Na) = e^{iN\phi}\psi(x).$$

- ▶ But if we impose periodic boundary conditions for a system with  $N$  unit cells

$$\psi(x + Na) = e^{iN\phi}\psi(x) = \psi(x),$$

so

$$\phi = \frac{2n\pi}{N},$$

where  $n$  is an integer. This corresponds to

$$\phi = ka,$$

where

$$k = \frac{2n\pi}{Na}$$

is one of the allowed wavevectors in the system of length  $Na$ .

- ▶ Now write the wavefunction in the form

$$\psi_k(x) = u_k(x)e^{ikx},$$

which satisfies

$$\psi_k(x + a) = e^{i\phi}\psi_k(x)$$

if

$$u(x + a) = u(x).$$

- ▶ In other words, we have *Bloch's theorem*: the wavefunction for an electron in a periodic potential can be written as a phase factor  $e^{ikx}$  times a function with the same periodicity as the potential.

- ▶ In 3D:

$$\psi_{\mathbf{k}}(\mathbf{r}) = e^{i\mathbf{k}\cdot\mathbf{r}}u_{\mathbf{k}}(\mathbf{r}).$$

- ▶ This gives the sort of wave we sketched before:

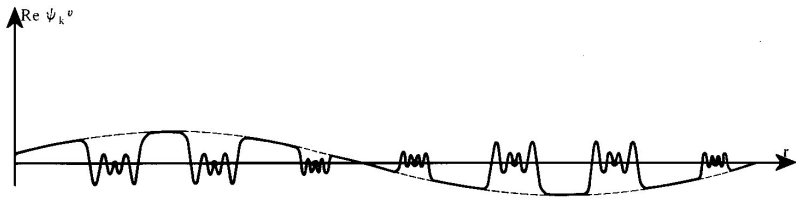

- ▶ A periodic function *modulated* by a travelling wave.
- ▶ The wave-vector,  $k$ , is significant whether we have free electrons ( $u_k(\mathbf{r}) = \text{constant}$ ) or not.

## 7.4 The Nearly Free Electron model

### 7.4.1 Basic ideas

- ▶ In one dimension, consider the two free electron wavefunctions

$$\psi_+(x) = L^{-1/2} e^{i\pi x/a} \quad \text{and} \quad \psi_-(x) = L^{-1/2} e^{-i\pi x/a}$$

where the  $L^{-1/2}$  normalizes over the length of the crystal,  $L$ . These both give constant electron densities  $1/L$ .

- ▶ But consider the combinations:

$$\psi_e(x) = \frac{1}{\sqrt{2}}(\psi_+(x) + \psi_-(x)) = \sqrt{\frac{2}{L}} \cos(\pi x/a)$$

$$\psi_o(x) = \frac{-i}{\sqrt{2}}(\psi_+(x) - \psi_-(x)) = \sqrt{\frac{2}{L}} \sin(\pi x/a).$$

The new states are standing waves, not travelling waves.

- ▶ See what the corresponding charge densities are like:

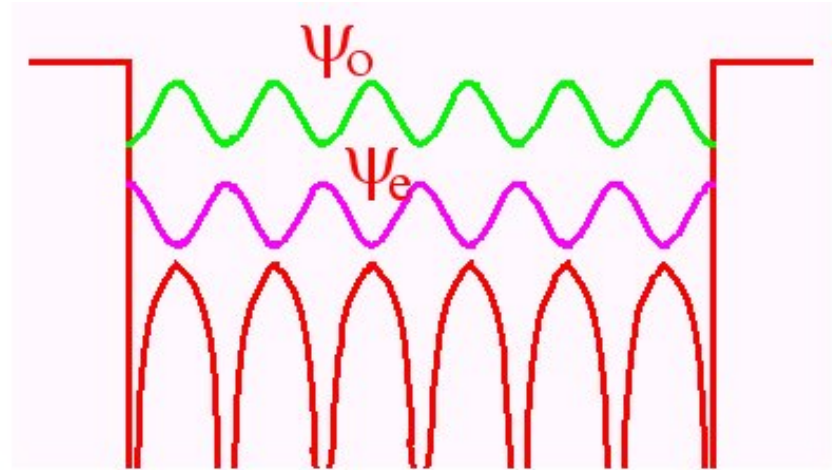

- ▶ It is clear that the even function has more charge density near the nuclei than the odd function, so we expect it to have lower energy.
- ▶ The crystal potential has split the degeneracy of the states with  $k = -\pi/a$  and  $k = \pi/a$  – there is an *energy gap* between them.
- ▶ As  $(\pi/a) - (-\pi/a) = 2\pi/a = G$ , a reciprocal lattice vector, we can imagine a wave with  $k = \pi/a$  being Bragg reflected by interacting with the potential to give a wave with  $k = -\pi/a$ .

### 7.4.2 Perturbation theory

- ▶ The idea of perturbation theory is to start with the solution to a problem, such as the free electron model, and assume



that the difference between that model and the real problem (in our case, the periodic potential) is in some sense small.

- ▶ That is, given a solution  $\psi^{(0)}$  to the free electron Hamiltonian  $\mathcal{H}^{(0)}$  with energy  $E^{(0)}$ , assume that the real hamiltonian is  $\mathcal{H} = \mathcal{H}^{(0)} + \lambda\mathcal{H}'$ , for some small parameter  $\lambda$ , and that the energy and the wavefunction may be written

$$\psi = \psi^{(0)} + \lambda\psi^{(1)} + \lambda^2\psi^{(2)} + \dots$$

and

$$E = E^{(0)} + \lambda E^{(1)} + \lambda^2 E^{(2)} + \dots$$

so that

$$\begin{aligned} (\mathcal{H}^{(0)} + \lambda\mathcal{H}')(\psi^{(0)} + \lambda\psi^{(1)} + \lambda^2\psi^{(2)} + \dots) &= (E^{(0)} + \lambda E^{(1)} + \lambda^2 E^{(2)} + \dots) \\ &\times (\psi^{(0)} + \lambda\psi^{(1)} + \lambda^2\psi^{(2)} + \dots). \end{aligned}$$

- ▶ Expanding, and collecting the powers of  $\lambda$ , we find the  $\lambda$ -independent term

$$\mathcal{H}^{(0)}\psi^{(0)} = E^{(0)}\psi^{(0)},$$

our original equation.

- ▶ The terms linear in  $\lambda$  give

$$\mathcal{H}^{(0)}\psi^{(1)} + \mathcal{H}'\psi^{(0)} = E^{(0)}\psi^{(1)} + E^{(1)}\psi^{(0)}.$$

- ▶ If we multiply through by  $\psi^{(0)}$  and integrate, using the notation

$$\int \phi(x)\mathcal{H}\xi(x)dx = \langle\phi|\mathcal{H}|\xi\rangle,$$

we find

$$\langle\psi^{(0)}|\mathcal{H}^{(0)}|\psi^{(1)}\rangle + \langle\psi^{(0)}|\mathcal{H}'|\psi^{(0)}\rangle = \langle\psi^{(0)}|E^{(0)}|\psi^{(1)}\rangle + \langle\psi^{(0)}|E^{(1)}|\psi^{(0)}\rangle,$$

- ▶ But

$$\mathcal{H}^{(0)}\psi^{(0)} = E^{(0)}\psi^{(0)}$$

means that (because the Hamiltonian is Hermitian) the first term

$$\langle\psi^{(0)}|\mathcal{H}^{(0)}|\psi^{(1)}\rangle = \langle\psi^{(1)}|\mathcal{H}^{(0)}|\psi^{(0)}\rangle^* = E^{(0)}\langle\psi^{(0)}|\psi^{(1)}\rangle$$

so

$$E^{(1)} = \langle\psi^{(0)}|\mathcal{H}'|\psi^{(0)}\rangle,$$

assuming normalised wavefunctions ( $\langle\psi^{(0)}|\psi^{(0)}\rangle = 1$ ).

- ▶ This is first order perturbation theory.

### 7.4.3 Fourier Analysis

- ▶ The one-dimensional periodic potential  $V(x)$  may be expanded as a Fourier series.
- ▶ As usual, for a function with period  $a$  we expand in exponentials of  $2n\pi x/a$ .
- ▶ But  $2\pi/a$  is a primitive reciprocal lattice vector. Generalizing to three dimensions:

$$V(\mathbf{r}) = \sum_{\mathbf{G}} V_{\mathbf{G}} e^{i\mathbf{G}\cdot\mathbf{r}}.$$

### 7.4.4 The Energy Gap

- ▶ In one dimension, the periodic potential is

$$V(x) = \sum_n (V_n e^{2\pi i n x/a} + V_{-n} e^{-2\pi i n x/a}),$$

and if we assume  $V$  is symmetrical about  $x = 0$  this is

$$V(x) = 2 \sum_n V_n \cos(2\pi nx/a).$$

- Now, using perturbation theory, the energy difference between the sin and cos functions will be

$$\begin{aligned} E_o - E_e &= \int_0^L 2 \sum_n V_n \cos(2\pi nx/a) \frac{2}{L} (\sin^2(\pi x/a) - \cos^2(\pi x/a)) dx \\ &= -\frac{4}{L} \sum_n V_n \int_0^L \cos(2\pi nx/a) \cos(2\pi x/a) dx \end{aligned}$$

and we know that only the  $n = 1$  term in the integral will survive, integrating up to  $L/2$ , so

$$E_o - E_e = -2V_1.$$

- The states at  $k = \pi/a$  are separated by an amount equal to twice the lowest Fourier component of the potential.
- Note: strictly speaking, we should be using degenerate perturbation theory, but we have side-stepped this by 'spotting' the correct combinations of degenerate states (the cos and sin functions).

### 7.5 An exactly-soluble model

- We know from second-year quantum mechanics that square well potentials are quite easy to deal with.

- The Kronig-Penney model is based on this.

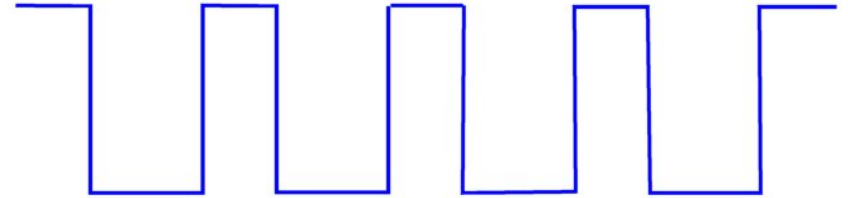

- For details of the calculation, see for example Kittel *Introduction to Solid State Physics*.

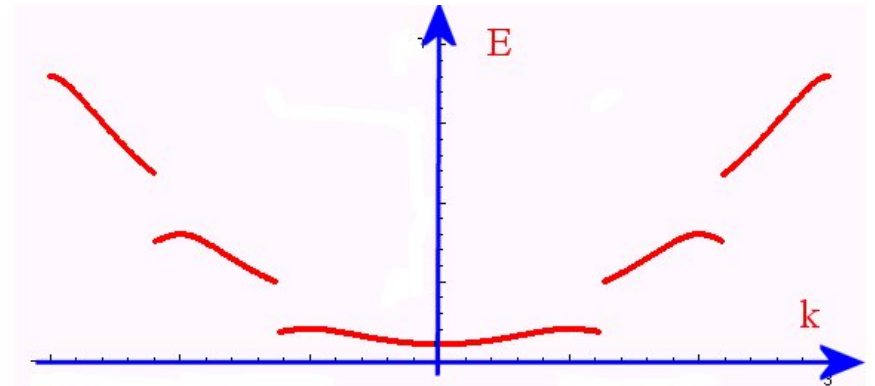

- We can see the gaps in the energy spectrum – regions of energy in which there are no allowed states.

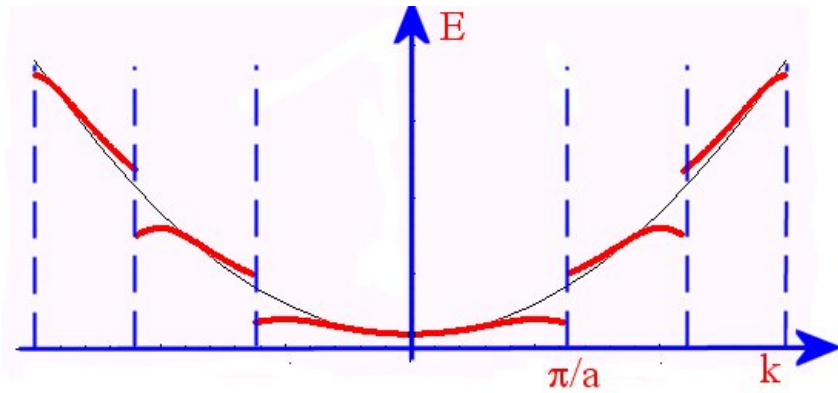

- ▶ The free electron approximation remains a good approximation well away from the edges of the Brillouin zone – only wave-vectors close to a multiple of  $\pi/a$  are mixed together and have their energies altered by the periodic potential.
- ▶ Translational symmetry is not essential for producing a band gap – amorphous solids also have band gaps.

## 7.6 Sketching energy bands

### 7.6.1 The empty lattice

- ▶ Imagine first that the periodic crystal potential is vanishingly small.
- ▶ Then we want to impose periodic structure without distorting the free electron dispersion curves. We now have

$$E(k) = E(k + G),$$

where  $G$  is a reciprocal lattice vector.

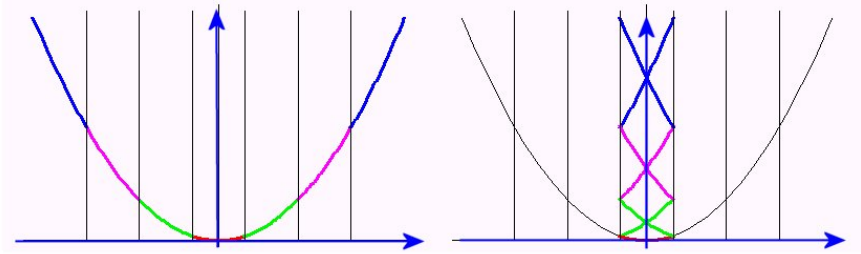

- ▶ We can use the *extended zone scheme* (left) or displace all the segments of the dispersion curve back into the first Brillouin zone (right).

### 7.6.2 The nearly free electron

- ▶ Modify the free electron picture by opening up small gaps near the zone boundaries.

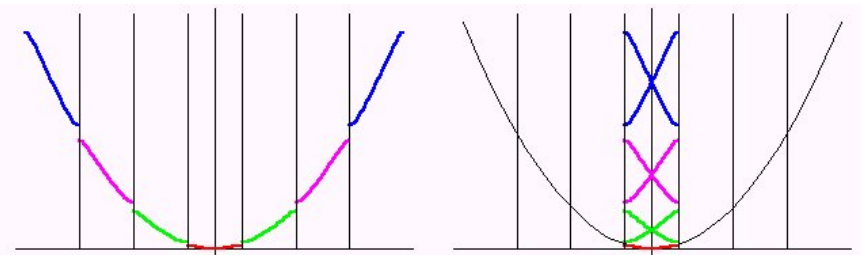

## 7.7 Consequences of the energy gap

### 7.7.1 Density of states

- ▶ The number of allowed  $k$  values in a Brillouin zone is equal to the number of unit cells in the crystal.

- *Proof:* in one dimension, with periodic boundary conditions,

$$g(k) = \frac{L}{2\pi},$$

where  $L$  is the length of the crystal,

- The number of states in a Brillouin zone is

$$N = \int_{-\pi/a}^{\pi/a} g(k)dk = \frac{L}{2\pi} \int_{-\pi/a}^{\pi/a} dk = \frac{L}{a},$$

- But  $a$  was the size of the real space unit cell, so  $N$  is the number of unit cells in the crystal.
- The same argument holds in two or three dimensions.
- Note that we get the number of unit cells – only for a monatomic unit cell is this the same as the number of atoms.
- So, taking spin degeneracy into account, a Brillouin zone contains  $2N$  allowed electron states.

- In the insulator, there is an energy gap between the occupied and unoccupied states.

- For a metal, there may be overlap (b) but *not* (c).

- Draw the dispersion relation with slight distortions near the zone boundary in either the extended zone scheme (left) or the reduced zone scheme (right).

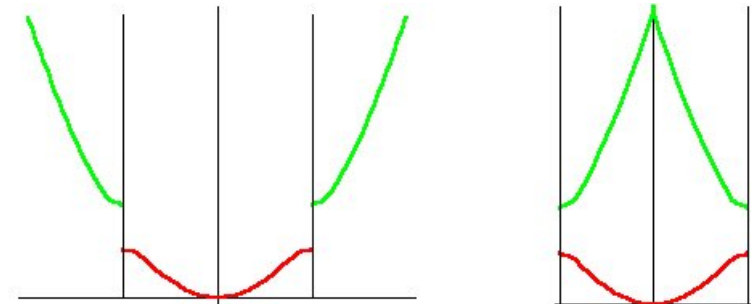

**7.7.2 States in one dimension**

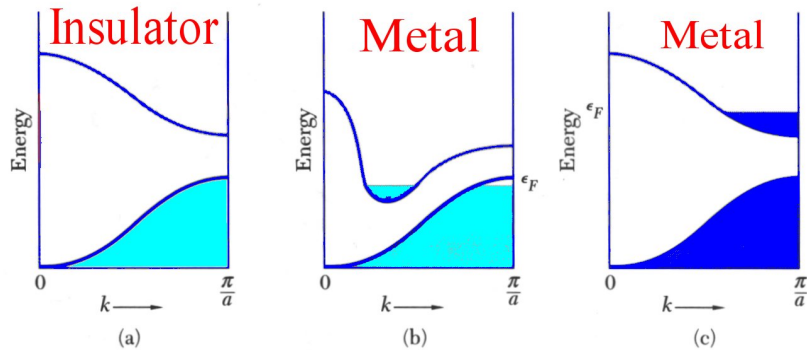

- Note that states further from the origin in the extended zone scheme can also be represented as higher bands in the reduced zone scheme.

- For free electrons, the constant energy surfaces are circular.

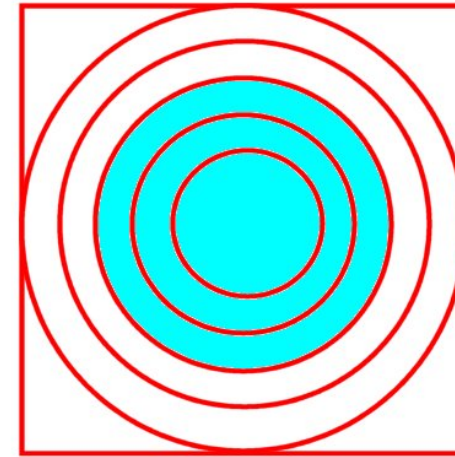
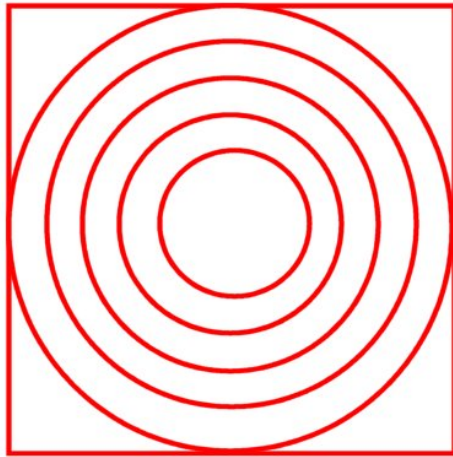

- ▶ For a monovalent element, the volume of the Fermi surface is half that of the Brillouin zone so that it is free to be displaced by an electric field – a free-electron-like *metallic* system.

- ▶ With the crystal potential, the energy inside the first Brillouin zone is *lower* close to the zone boundary.

- ▶ So the Fermi surface is extended *towards* the zone boundary as it gets close.

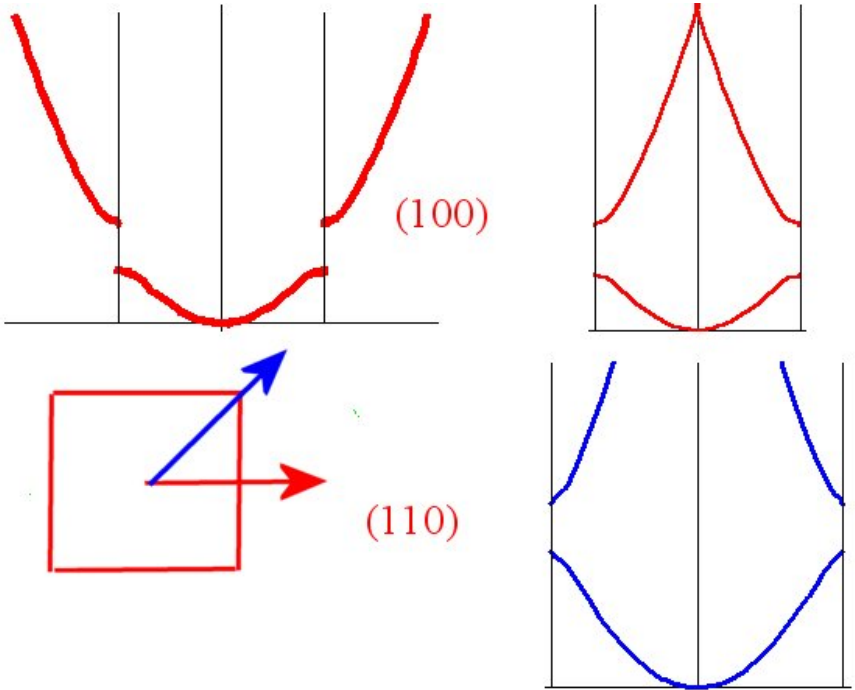
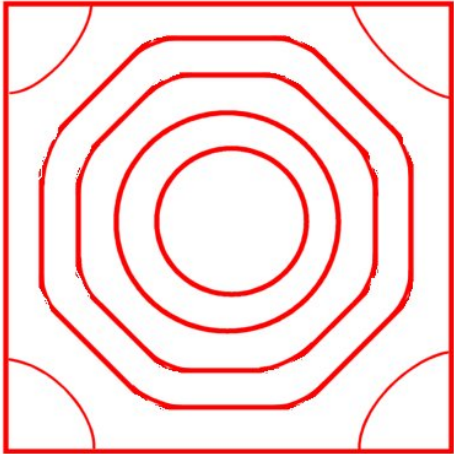

- ▶ Depending on the direction in the Brillouin zone, we may go to larger  $k$  (larger  $E$ ) before the states are perturbed.
- ▶ We can see that the red states in the second band will start to be filled.
- ▶ Consider a divalent metal in two dimensions.
- ▶ The area of  $k$ -space needed to accommodate all the electrons is equal to the area of the first Brillouin zone.

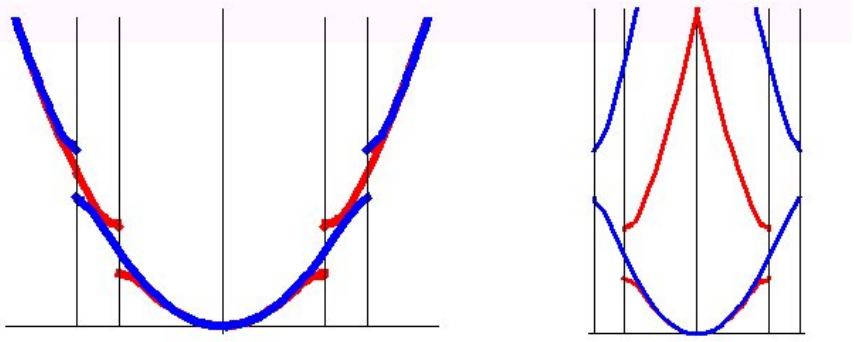

► If the gap is small, the filled states will be in both the first and second zones. This will be a metal.

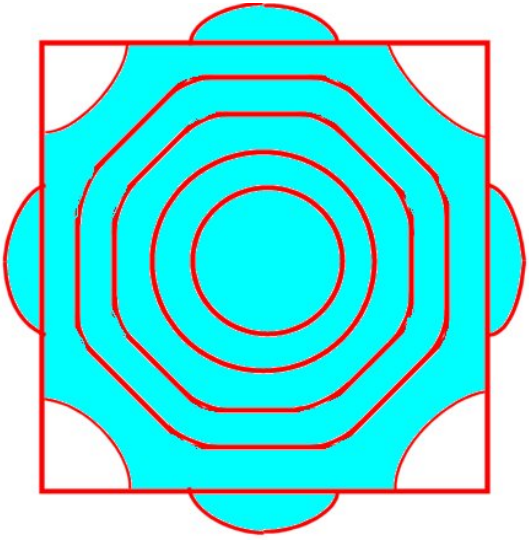

► Take a larger energy gap

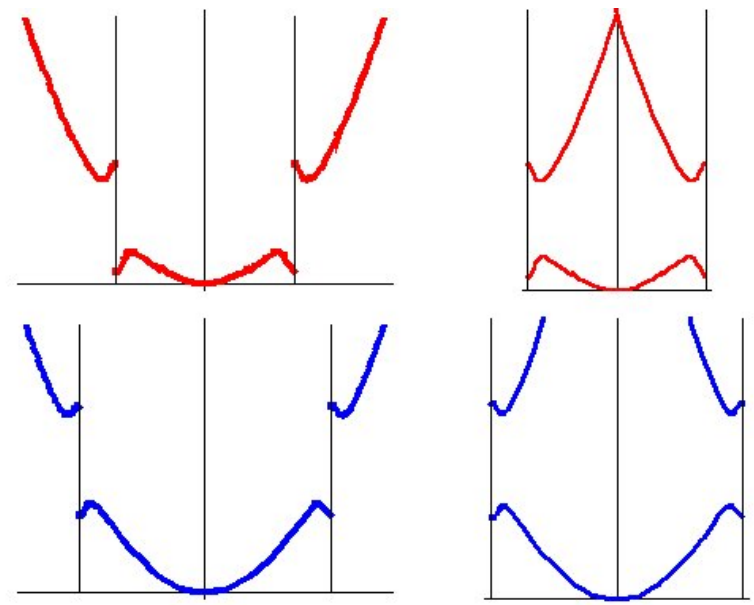

► Superpose the curves

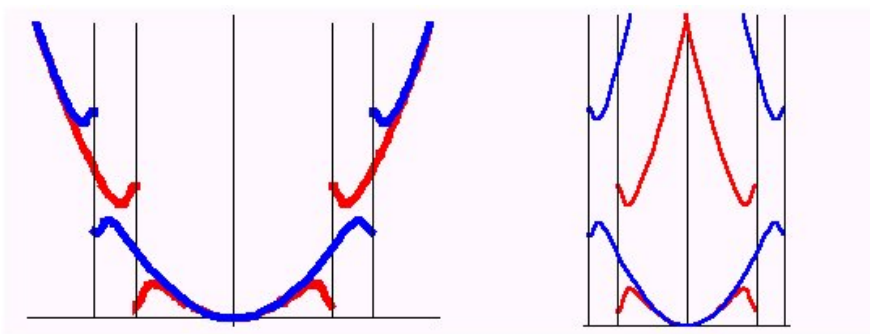

- For a large gap, the whole of the first zone will be filled.
- This gives an insulator because if we apply a field to increase an electron's  $k$  vector, electrons at the zone boundary will be

Bragg reflected back to the other side of the zone – there will be no net drift velocity.

- ▶ We only get current if we can excite some electrons into a higher energy band. It is an insulator.

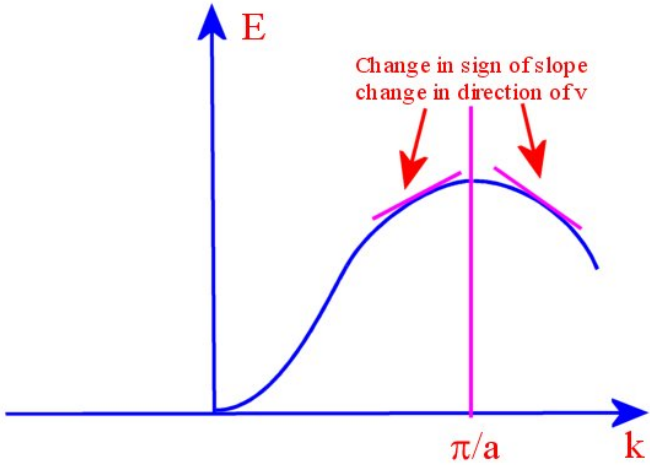
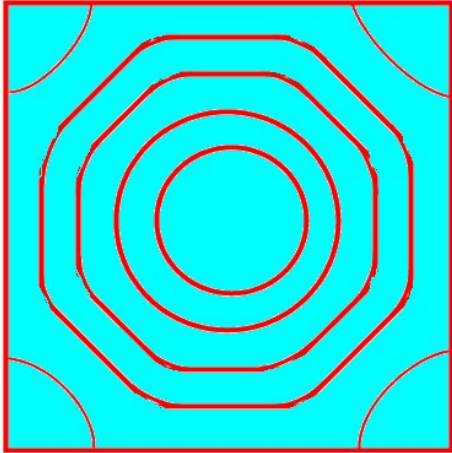

- ▶ On crossing the zone boundary, the phase velocity changes direction: the electron is reflected.

- ▶ Bragg reflection is a natural consequence of the periodic nature of the energy in  $k$ -space, and the fact that

$$\text{group velocity} = \frac{d\omega}{dk} = \frac{1}{\hbar} \frac{dE}{dk}.$$

**7.7.3 Sketching a nearly free electron Fermi surface**

- ▶ Start with the sphere, and distort it near the edges of the zone.



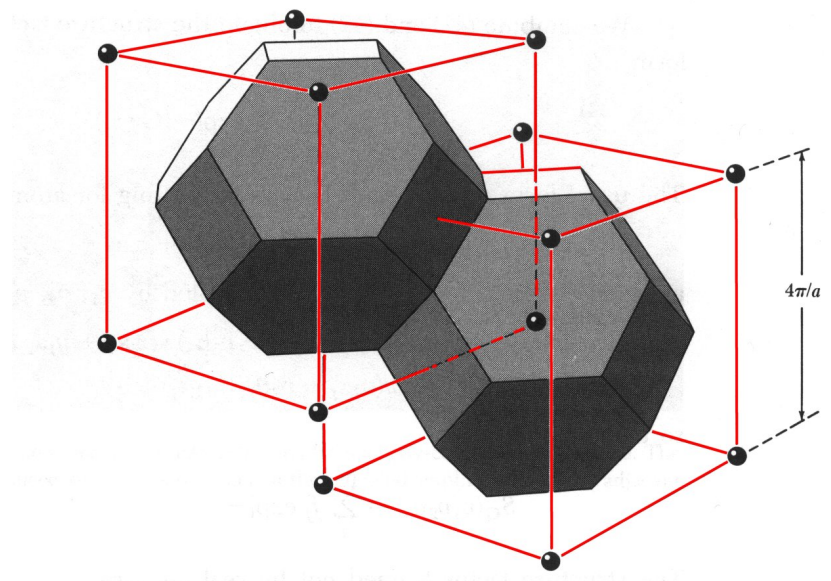
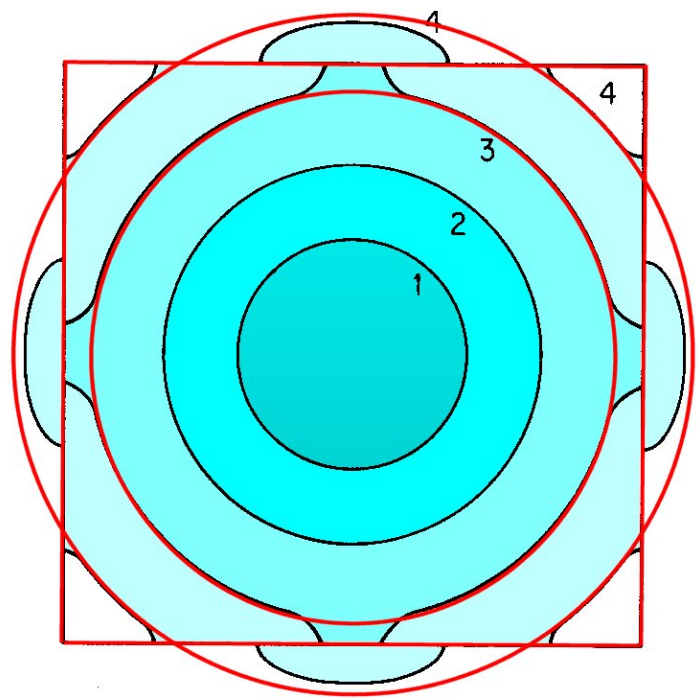

**7.7.4 Typical Fermi surfaces in 3D**

► The Brillouin zone is taken as the reciprocal space Wigner-Seitz cell.

► FCC lattice, BCC reciprocal lattice

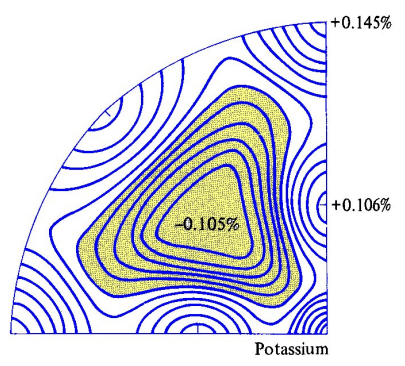
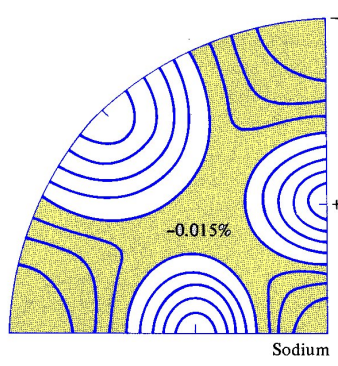
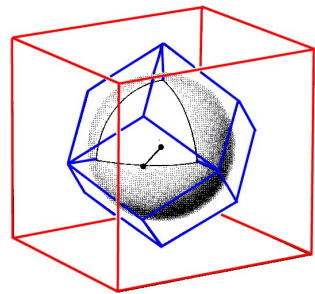
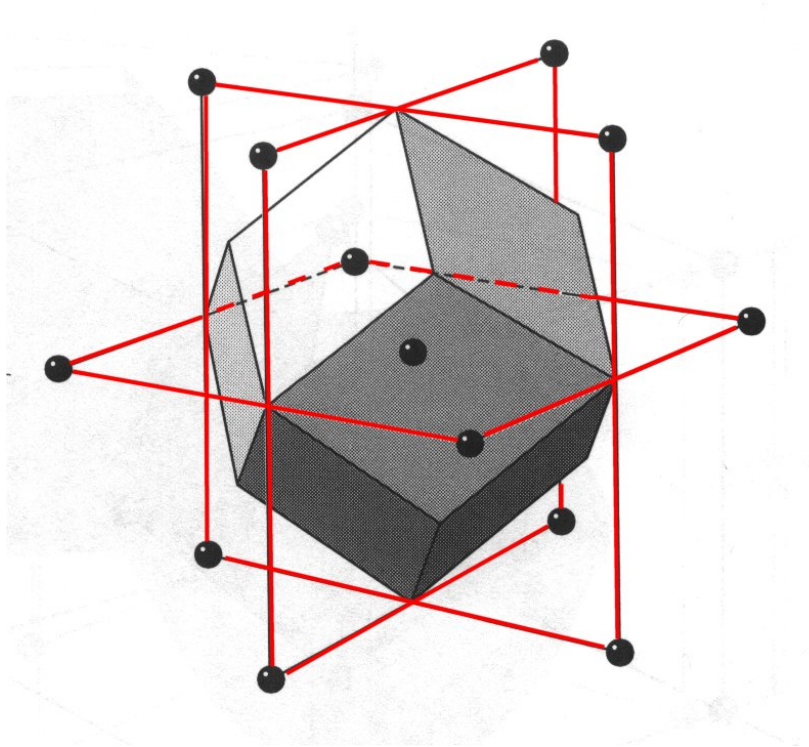

► BCC lattice, FCC reciprocal lattice. The alkali metals are only slightly distorted from spheres.

► The noble metals are connected in  $k$ -space.

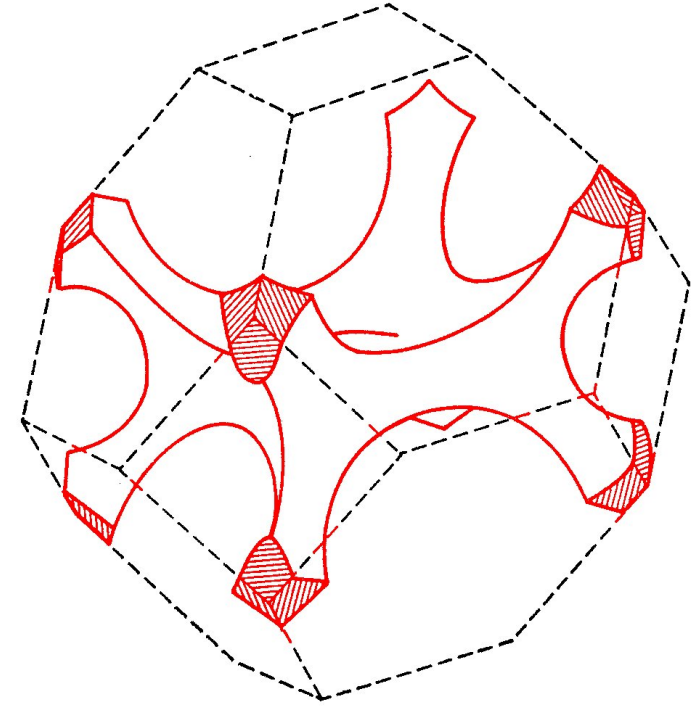
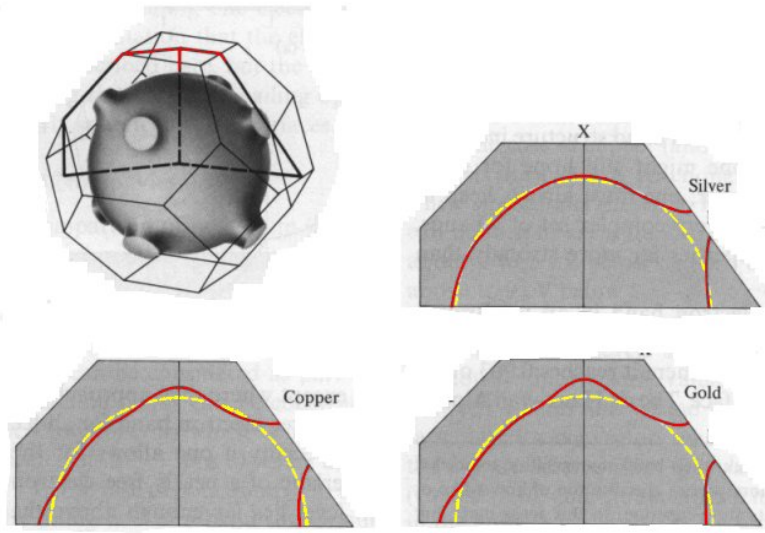

**7.7.5 Effects of fields on electrons in bands**

- ▶ For polyvalent materials, the Fermi surfaces get more complicated.
- ▶ *Electric field*: a simple picture will show how the Fermi surface in a partly-filled zone will be shifted:

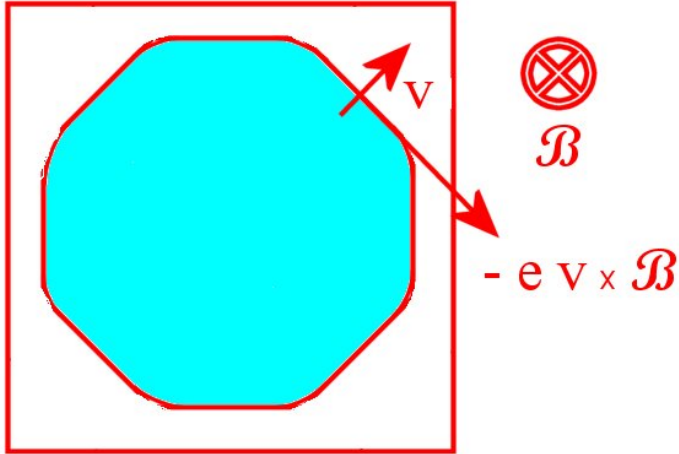
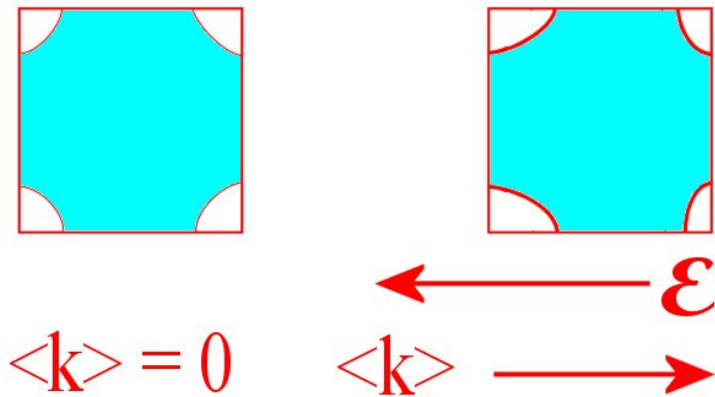

► A nett current flow (really arising from  $\langle \mathbf{v} \rangle$ , not  $\langle \mathbf{k} \rangle$ ), so a conductor.

► The change in  $\mathbf{k}$  is perpendicular to both  $\mathbf{v}$  and  $\mathcal{B}$  – the electron stays on the constant energy surface.

► *Magnetic field:*

$$\hbar \frac{d\mathbf{k}}{dt} = -e\mathbf{v} \times \mathcal{B}.$$

► Near the top of a band:

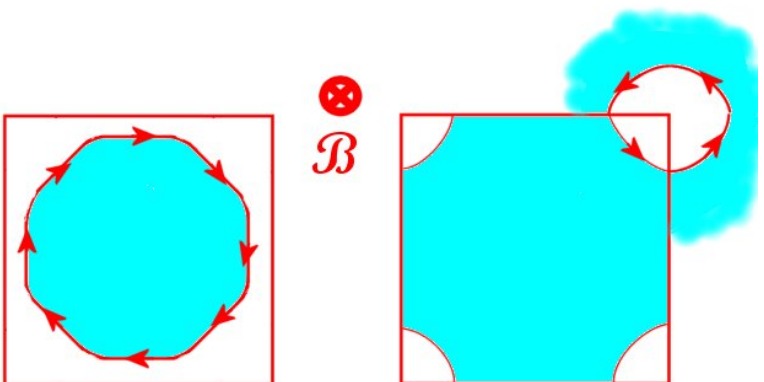
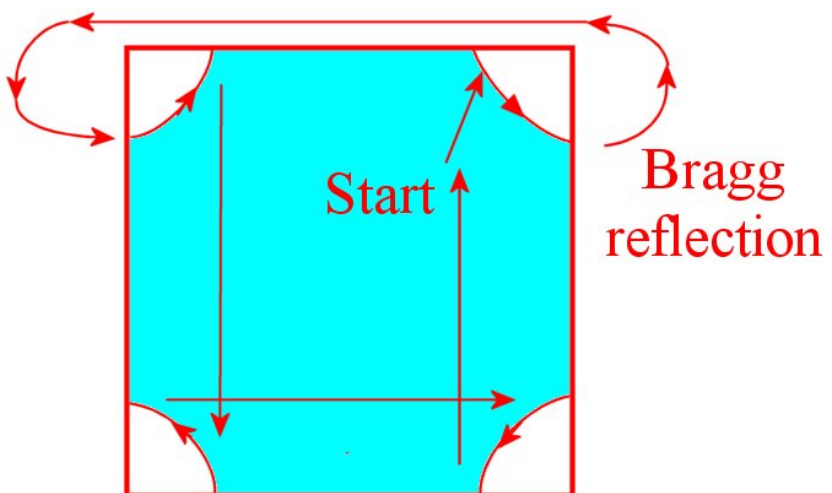
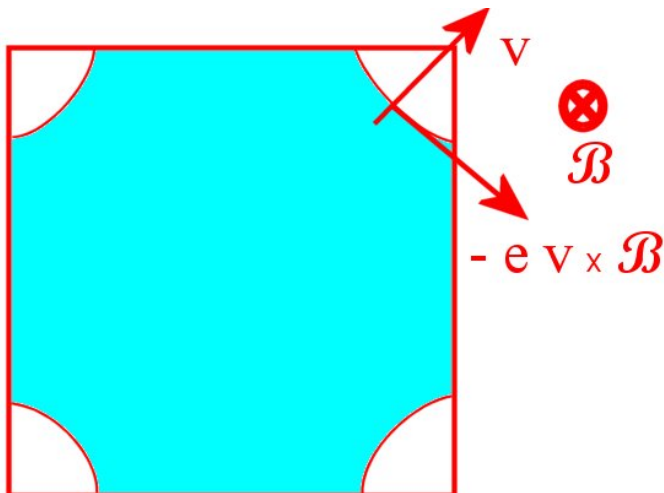

► The electrons are Bragg reflected at the edges of the Brillouin zone.

► The electrons orbit, in  $k$ -space, the opposite way round occu-

pied or unoccupied states.

- ▶ The behaviour looks like that of an oppositely charged particle – a *hole*.
- ▶ What about the electrons in the second zone in a metallic system?

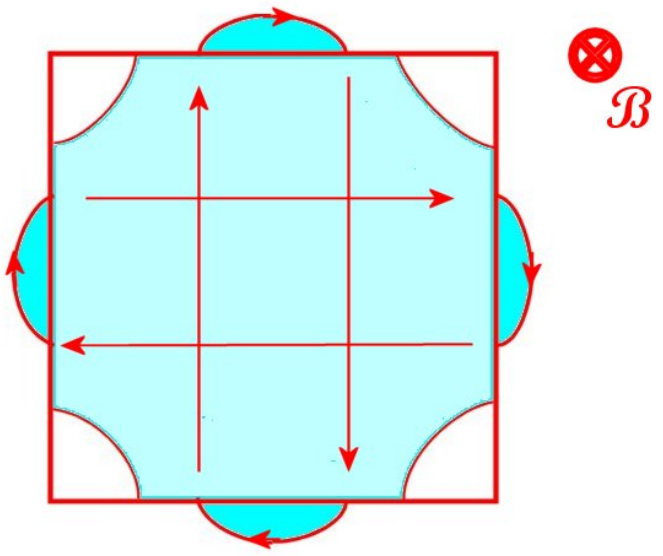

- ▶ Redrawing, using the periodic nature of the system:

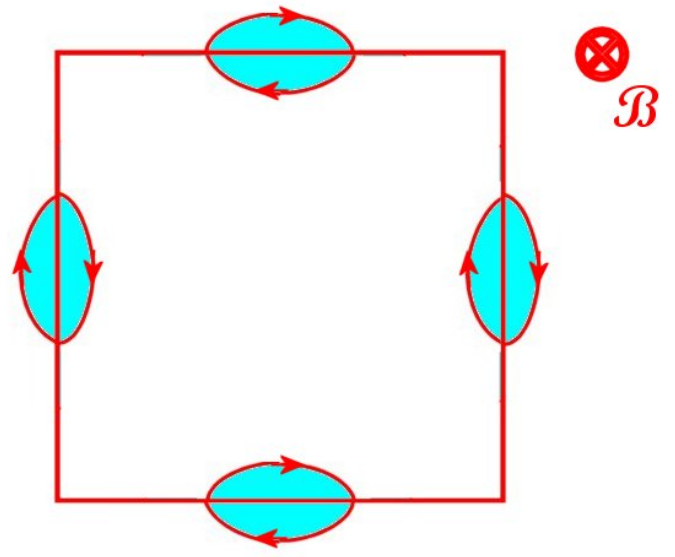

- ▶ This is electron-like behaviour.
- ▶ There can be a balance between electron-like and hole-like behaviour – hence the strange Hall coefficients of the polyvalent metals.

### 7.8 The tight-binding model

**THIS TOPIC IS NOT TAUGHT THIS YEAR, AND WILL NOT APPEAR IN YOUR EXAM. HOWEVER, THE FOLLOWING NOTES FROM PREVIOUS YEARS HAVE BEEN RETAINED FOR THOSE WHO ARE CURIOUS ABOUT THIS VERY POWERFUL APPROACH.**

### 7.8.1 Overview

- ▶ For materials which are formed from closed-shell atoms or ions, or even covalent solids, the free electron model seems inappropriate.
- ▶ In the tight-binding model, we imagine how the wavefunctions of atoms or ions will interact as we bring them together.
- ▶ For example, take two hydrogen atoms,  $A$  and  $B$ , and consider the states  $\psi_A \pm \psi_B$ .

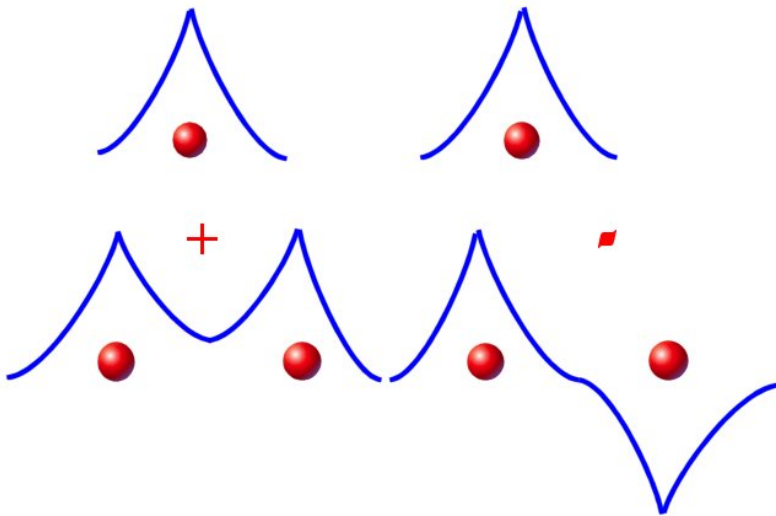

- ▶ The symmetric (+) form has more screening charge between the nuclei, and has lower energy.

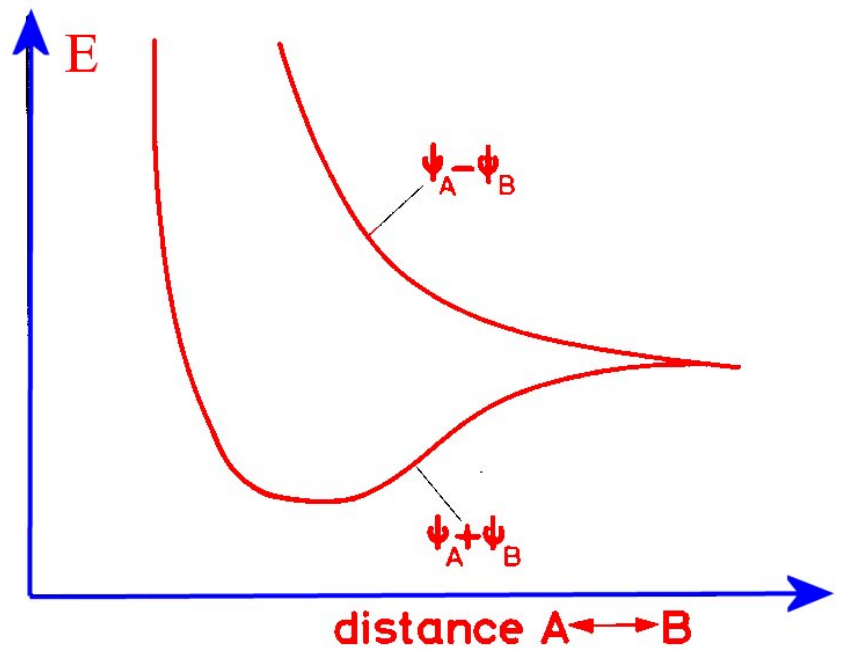

- ▶ When more atoms are brought together, the degeneracies are further split - to form bands ranging from fully bonding to fully antibonding.
- ▶ Different orbitals can lead to band overlap.

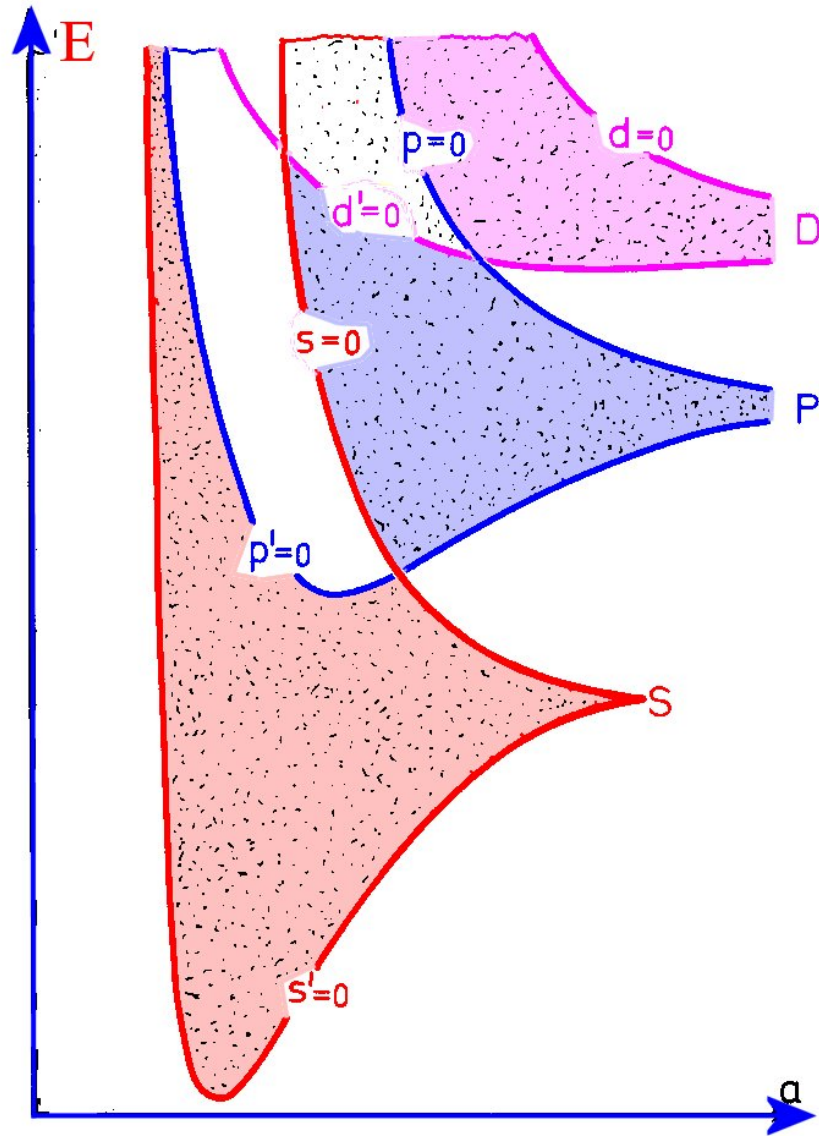

### 7.8.2 Tight-binding theory

- ▶ Consider an element with one atom per unit cell, and suppose that each atom has only one valence orbital,  $\phi(\mathbf{r})$ .
- ▶ Then we can make a wavefunction of Bloch form by forming

$$\psi_{\mathbf{k}}(\mathbf{r}) = N^{-1/2} \sum_m \exp(i\mathbf{k} \cdot \mathbf{R}_m) \phi(\mathbf{r} - \mathbf{R}_m).$$

- ▶ Confirm that this is a Bloch function. If  $\mathbf{T}$  is a translation vector:

$$\begin{aligned} \psi_{\mathbf{k}}(\mathbf{r} + \mathbf{T}) &= N^{-1/2} \sum_m \exp(i\mathbf{k} \cdot \mathbf{R}_m) \phi(\mathbf{r} - \mathbf{R}_m + \mathbf{T}) \\ &= N^{-1/2} \exp(i\mathbf{k} \cdot \mathbf{T}) \sum_m \exp(i\mathbf{k} \cdot (\mathbf{R}_m - \mathbf{T})) \phi(\mathbf{r} - (\mathbf{R}_m - \mathbf{T})) \\ &= \exp(i\mathbf{k} \cdot \mathbf{T}) \psi_{\mathbf{k}}(\mathbf{r}) \end{aligned}$$

because if  $\mathbf{R}_m$  is a lattice vector, so is  $\mathbf{R}_m - \mathbf{T}$ .

- ▶ Find the expectation energy of the Hamiltonian:

$$\langle \mathbf{k} | \mathcal{H} | \mathbf{k} \rangle = N^{-1} \sum_m \sum_n \exp(i\mathbf{k} \cdot (\mathbf{R}_n - \mathbf{R}_m)) \langle \phi_m | \mathcal{H} | \phi_n \rangle$$

where  $\phi_m = \phi(\mathbf{r} - \mathbf{R}_m)$ .

- ▶ Now  $\langle \phi_m | \mathcal{H} | \phi_n \rangle$  will be large if  $n$  and  $m$  are the same atomic site, or nearest neighbours, but will decrease rapidly with separation.



► Write

$$\begin{aligned}\langle \phi_n | \mathcal{H} | \phi_n \rangle &= -\alpha, \\ \langle \phi_m | \mathcal{H} | \phi_n \rangle &= -\gamma \text{ if } n \text{ and } m \text{ are nearest neighbours,}\end{aligned}$$

Then

$$E_{\mathbf{k}} = \langle \mathbf{k} | \mathcal{H} | \mathbf{k} \rangle = -\alpha - \gamma \sum_n \exp(i\mathbf{k} \cdot \mathbf{R}_n),$$

where the sum is over nearest neighbours only, and  $\mathbf{R}_n$  is a vector joining an atom to its nearest neighbours.

► For example, in two-dimensional square lattice we have

$$\{\mathbf{R}_n\} = \{(a, 0), (-a, 0), (0, a), (0, -a)\}$$

so that if  $\mathbf{k} = (k_x, k_y)$

$$E_{\mathbf{k}} = -\alpha - 2\gamma(\cos(k_x a) + \cos(k_y a)).$$

► Clearly, as  $\cos$  ranges between  $-1$  and  $1$   $E_{\mathbf{k}}$  ranges between  $-\alpha - 4\gamma$  and  $-\alpha + 4\gamma$ , giving a band width of  $8\gamma$ .

► Near  $\mathbf{k} = 0$  we can expand the  $\cos$  functions as

$$\cos \theta \approx 1 - \frac{1}{2}\theta^2,$$

so

$$\begin{aligned}E_{\mathbf{k}} &\approx -\alpha - 2\gamma\left(1 - \frac{1}{2}k_x^2 a^2 + 1 - \frac{1}{2}k_y^2 a^2\right) \\ &= -\alpha - 4\gamma + \gamma(k_x^2 + k_y^2)a^2\end{aligned}$$

which is free-electron-like, giving circular constant-energy surfaces near the centre of the Brillouin zone.

► If both  $k_x$  and  $k_y$  are close to  $\pi/a$ , write

$$k_x = \frac{\pi}{a} - \delta_x \quad k_y = \frac{\pi}{a} - \delta_y,$$

so that, remembering

$$\cos(a - b) = \cos(a)\cos(b) + \sin(a)\sin(b),$$

we have

$$\begin{aligned}E_{\mathbf{k}} &= -\alpha - 2\gamma(\cos(\pi - \delta_x a) + \cos(\pi - \delta_y a)) \\ &= -\alpha - 2\gamma(\cos(\pi)\cos(\delta_x a) - \sin(\pi)\sin(\delta_x a) \\ &\quad + \cos(\pi)\cos(\delta_y a) - \sin(\pi)\sin(\delta_y a)) \\ &= -\alpha + 2\gamma(\cos(\delta_x a) + \cos(\delta_y a)) \\ &= -\alpha + 4\gamma - \gamma(\delta_x^2 + \delta_y^2)a^2\end{aligned}$$

giving circular constant-energy surfaces near the zone corners too.

► Finally, in the middle of the band

$$\cos(k_x a) + \cos(k_y a) = 0,$$

the solutions to which are of the form

$$k_x a = \pi - k_y a,$$

or straight lines.

► Overall, then, we have the constant energy surfaces for this tight-binding model.

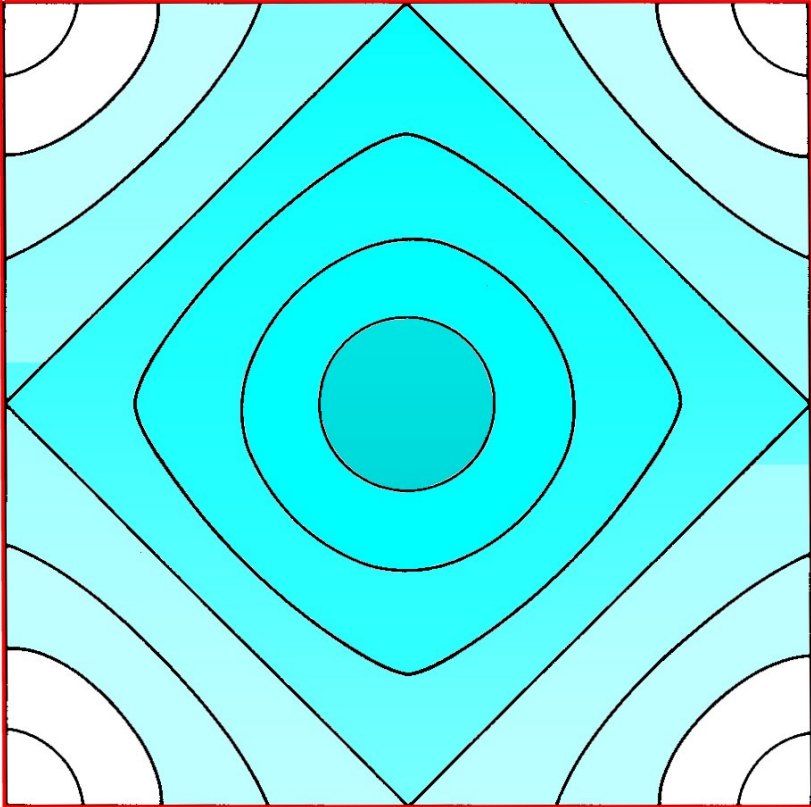

► A real band structure.

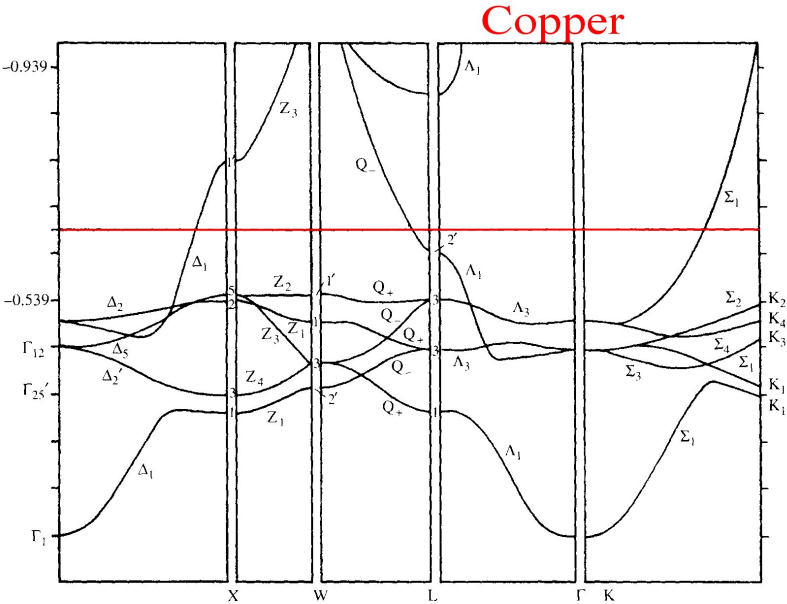

### 7.8.3 Comments on tight binding theory

- Note that band width depends on two-centre integrals ( $\gamma$ ): for transition metals, this leads to narrow d-bands and wide s-bands.
- Near the top and bottom of bands, we have quadratic dependence on  $k$ .

# Chapter 8

## Electrons and Holes

### 8.1 Preliminaries

#### 8.1.1 Required Knowledge

- ▶ Quantum mechanics
- ▶ Newton's laws
- ▶ Force on charge due to electric and magnetic fields

#### 8.1.2 Reading

- ▶ Hook and Hall 5.1-5.2

### 8.2 Equations of motion

- ▶ In one dimension, an electron with wave-vector  $k$  has group velocity

$$v = \frac{d\omega}{dk} = \frac{1}{\hbar} \frac{dE}{dk}. \quad (8.1)$$

- ▶ If an electric field  $\mathcal{E}$  acts on the electron, then in time  $\delta t$  it will do work

$$\delta E = \text{force} \times \text{distance} = -e\mathcal{E}v \delta t. \quad (8.2)$$

- ▶ But

$$\delta E = \frac{dE}{dk} \delta k = \hbar v \delta k, \quad (8.3)$$

- ▶ so, comparing eq 8.2 with 8.3 we have

$$\delta k = -\frac{e\mathcal{E}}{\hbar} \delta t,$$

or

$$\hbar \frac{dk}{dt} = -e\mathcal{E}.$$

- In terms of force,  $\mathcal{F}$ ,

$$\hbar \frac{dk}{dt} = \mathcal{F}. \quad (8.4)$$

- Generalising to three dimensions:

$$\mathbf{v} = \frac{1}{\hbar} \nabla_{\mathbf{k}} E,$$

where

$$\nabla_{\mathbf{k}} = \hat{i} \frac{d}{dk_x} + \hat{j} \frac{d}{dk_y} + \hat{k} \frac{d}{dk_z},$$

and

$$\hbar \frac{d\mathbf{k}}{dt} = \mathcal{F}.$$

- Similarly, if there is a magnetic field acting,

$$\hbar \frac{d\mathbf{k}}{dt} = -e\mathbf{v} \times \mathcal{B},$$

or

$$\frac{d\mathbf{k}}{dt} = -\frac{e}{\hbar^2} (\nabla_{\mathbf{k}} E) \times \mathcal{B}.$$

- Remember that as  $\mathbf{k}$  moves in a direction *perpendicular* to the gradient of energy with respect to  $\mathbf{k}$ , the electron stays on a surface of constant energy in  $k$ -space.

## 8.3 Effective mass

- The energy near the bottom of a band can be written as

$$E(\mathbf{k}) \approx E_0 + A(\mathbf{k} - \mathbf{k}_{\min})^2,$$

$\mathbf{k}_{\min}$  being the  $\mathbf{k}$  value where the energy was a minimum

- Near the top of the band (the corner of the Brillouin zone in our two-dimensional example) it can be written as

$$E(\mathbf{k}) \approx E_1 - B(\mathbf{k} - \mathbf{k}_{\max})^2,$$

$\mathbf{k}_{\max}$  being the  $\mathbf{k}$  value where the energy was a maximum.

- For example, Germanium:

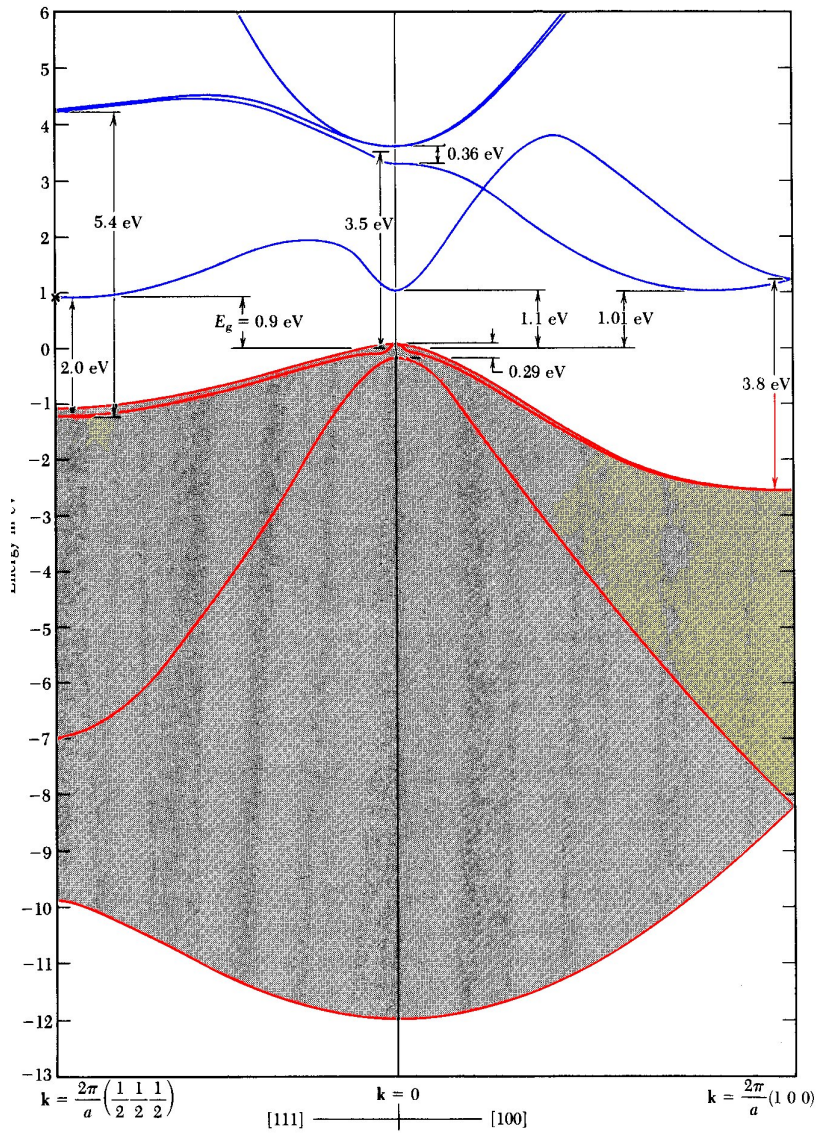

► We call the lower set of states, fully occupied at  $T = 0$ , the va-

lence band, and the upper set, empty at  $T = 0$ , the conduction band.

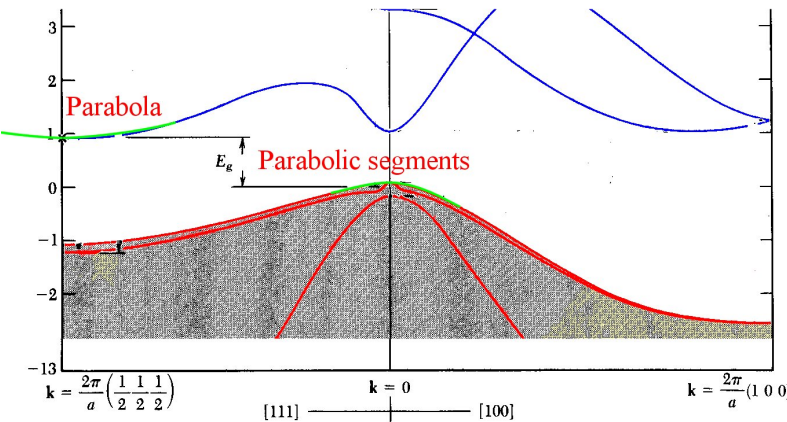

► In a region close to the maxima and minima, a parabolic approximation can be accurate.

► From equation 8.1

$$v = \frac{d\omega}{dk} = \frac{1}{\hbar} \frac{dE}{dk}$$

► Differentiating with respect to time

$$\frac{dv}{dt} = \frac{1}{\hbar} \frac{d^2E}{dk dt} = \frac{1}{\hbar} \frac{d^2E}{dk^2} \frac{dk}{dt}$$

► But from equation 8.4

$$\hbar \frac{dk}{dt} = \mathcal{F}$$

so

$$\frac{dv}{dt} = \frac{1}{\hbar^2} \frac{d^2 E}{dk^2} \mathcal{F}.$$

► But from Newton's equation we expect

$$\frac{dv}{dt} = \frac{1}{m} \mathcal{F},$$

which leads us to define an effective mass

$$\frac{1}{m^*} = \frac{1}{\hbar^2} \frac{d^2 E}{dk^2}.$$

► That is

- ▷ the dynamics of electrons is modified by the crystal potential;
- ▷ the effective mass depends on the *curvature* of the bands;
- ▷ flat bands have large effective masses;
- ▷ near the bottom of a band,  $m^*$  is positive, near the top of a band,  $m^*$  is negative.

► In three dimensions, constant energy surfaces are not necessarily spherical, and the effective mass is a tensor:

$$\left( \frac{1}{m^*} \right)_{ij} = \frac{1}{\hbar^2} \frac{d^2 E}{dk_i dk_j}.$$

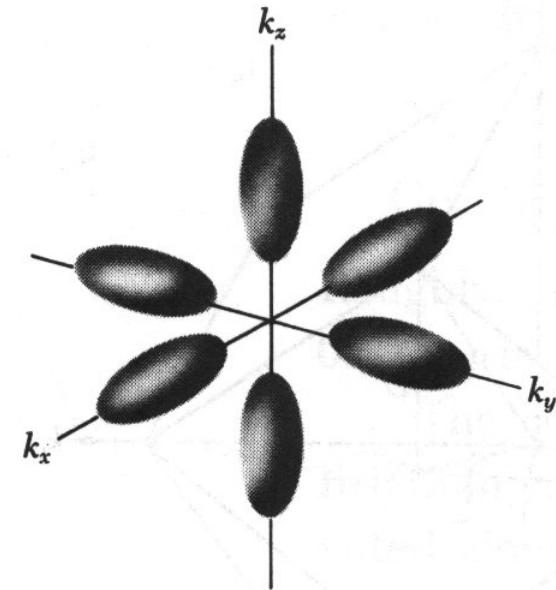

### 8.3.1 Typical effective masses for semiconductors

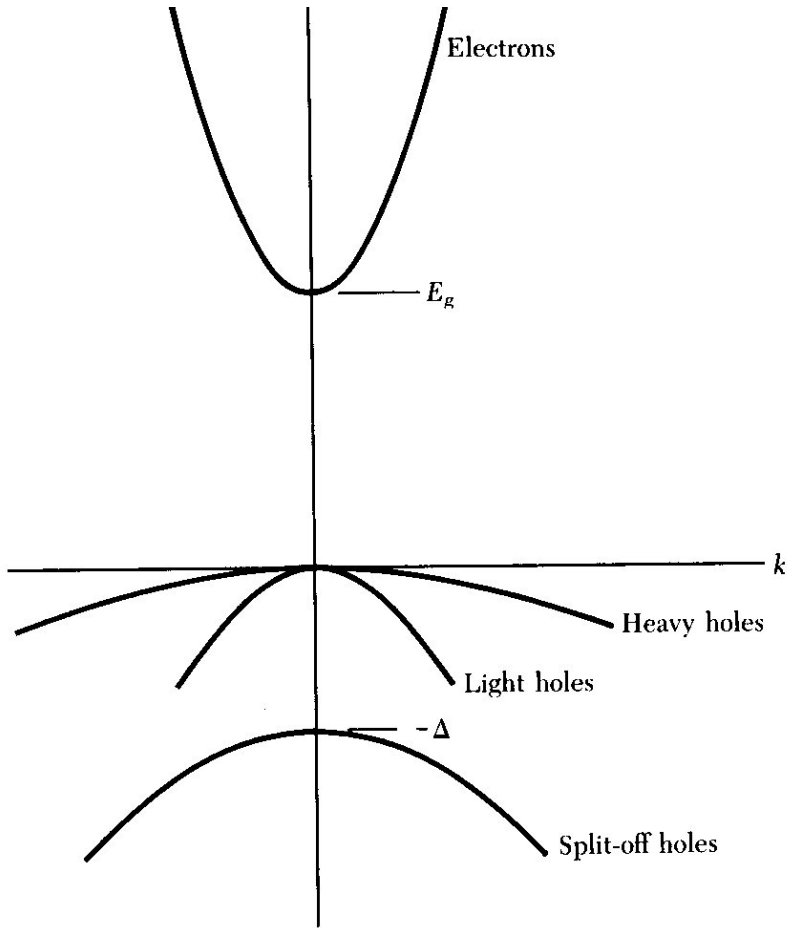

► Note that the top of the valence band is often degenerate, with heavy and light holes and a split-off hole band arising from spin-orbit coupling.

	Mass relative to free electron				$\Delta/eV$
	Electron	Heavy hole	Light hole	Split-off hole	
Si	0.19-0.92	0.52	0.16	-	0.2
Ge	0.082-1.59	0.34	0.043	-	0.8
InSb	0.015	0.39	0.021	0.11	0.8
InAs	0.026	0.41	0.025	0.08	0.4
InP	0.073	0.4	0.078	0.15	0.1
GaSb	0.047	0.3	0.06	0.14	0.8
GaAs	0.066	0.5	0.082	0.17	0.3

► *Important message:* effective masses in semiconductors are often one tenth of the free electron mass or less.

### 8.4 Electrons and holes

- We have discussed a full band (a full Brillouin zone) in terms of Bragg reflection, and shown that it does not respond to electric fields to produce an electric current.
- For a simple model in one dimension

$$E_k = -\alpha - 2\gamma \cos(ka),$$

so the electron velocity is

$$v = \frac{2\gamma a}{\hbar} \sin(ka).$$

and the effective mass is

$$m^* = \frac{\hbar^2}{2\gamma a^2 \cos(ka)},$$

which is negative near the top of the band,  $k = \pm\pi/a$ .

- ▶ It is clear that if we integrate  $v$  over a Brillouin zone ( $-\pi/a \leq k \leq \pi/a$ ) we are integrating  $\sin$  over a period, and we get zero.
- ▶ Even if the electrons drift under the influence of an electric field, there are as many electrons at the top of the band moving against the field as there are at the top of the band moving with the field.
- ▶ But if the band is not full, we can have a net current.
- ▶ If we have somehow managed to excite a few electrons from the valence bands into the conduction bands, leaving a few holes in the valence bands, it may be easier to focus on the behaviour of the holes.

### 8.4.1 Hole wavevector

- ▶ The total  $\mathbf{k}$  of a full band is zero: if we remove an electron with wavevector  $\mathbf{k}_e$  the total  $\mathbf{k}$  of the band is

$$\mathbf{k}_h = 0 - \mathbf{k}_e = -\mathbf{k}_e.$$

### 8.4.2 Hole energy

- ▶ Take the energy zero to be the top of the valence band.
- ▶ The lower the electron energy, the more energy it takes to remove it: thus

$$E_h(\mathbf{k}_e) = -E_e(\mathbf{k}_e),$$

- ▶ But bands are usually symmetric,

$$E(\mathbf{k}) = E(-\mathbf{k})$$

so

$$E_h(\mathbf{k}_h) = E_h(-\mathbf{k}_h) = -E_e(\mathbf{k}_e).$$

### 8.4.3 Hole velocity

- ▶ In three dimensions

$$v_h = \frac{1}{\hbar} \nabla_{\mathbf{k}_h} E_h,$$

- ▶ but

$$\mathbf{k}_h = -\mathbf{k}_e$$

- ▶ so

$$\nabla_{\mathbf{k}_h} = -\nabla_{\mathbf{k}_e}$$

- ▶ and so

$$v_h = -\frac{1}{\hbar} \nabla_{\mathbf{k}_e} (-E_e) = v_e.$$

- ▶ The group velocity of the hole is the same as that of the electron.

### 8.4.4 Hole effective mass

- ▶ The curvature of  $E$  is just the negative of the curvature of  $-E$ , so

$$m_h^* = -m_e^*.$$



- Note that this has the pleasant effect that if the electron effective mass is negative, as it is at the top of the band, the equivalent hole has a positive effective mass.

### 8.4.5 Hole dynamics

- We know that

$$\hbar \frac{d\mathbf{k}_e}{dt} = -e(\mathcal{E} + \mathbf{v}_e \times \mathcal{B}),$$

- Substituting  $\mathbf{k}_h = -\mathbf{k}_e$  and  $\mathbf{v}_h = \mathbf{v}_e$  gives

$$\hbar \frac{d\mathbf{k}_h}{dt} = e(\mathcal{E} + \mathbf{v}_h \times \mathcal{B}),$$

- *Exactly the equation of motion for a particle of positive charge.*
- Under an electric field, electrons and holes acquire drift velocities in opposite directions, but both give electric current in the direction of the field.

### 8.4.6 Experimental

- Under a magnetic field  $\mathcal{B}$ , electrons move in helical paths (orbits around the field direction, uniform motion parallel to  $\mathcal{B}$ ), with angular frequency

$$\omega_c = \frac{e\mathcal{B}}{m^*},$$

which is called the *cyclotron frequency*.

- Electrons can absorb energy from an electromagnetic field of the appropriate frequency – *cyclotron resonance* – this is how effective masses can be measured.

### 8.4.7 Mobility and conductivity

- We define mobilities for electrons and holes in the relaxation time approximation as

$$\mu_e = \frac{e\tau}{m_e^*}, \quad \mu_h = \frac{e\tau}{m_h^*}$$

- Then the total current is the sum of electron and hole currents,

$$J = -en_e v_e + en_h v_h,$$

and the conductivity is

$$\sigma = n_e e \mu_e + n_h e \mu_h,$$

or

$$\sigma = n_e \frac{e^2 \tau}{m_e^*} + n_h \frac{e^2 \tau}{m_h^*}.$$

- Note that we have assumed equal relaxation times,  $\tau$ , for electrons and holes – this is not necessarily true.

# Chapter 9

## Physics of Semiconductors

### 9.1 Preliminaries

#### 9.1.1 Required Knowledge

- ▶ Fermi-Dirac distribution
- ▶ Hydrogen atom
- ▶ Force on electron in electric and magnetic fields
- ▶ Differential equations
- ▶ Poisson's equation

#### 9.1.2 Reading

- ▶ Hook and Hall 5.3-5.6, 6.1-6.5

### 9.2 Creating free carriers

- ▶ At absolute zero, a pure semiconductor has a full valence band and an empty conduction band – there are no *free carriers*.
- ▶ Create free carriers by:
  - ▷ absorbing photons
  - ▷ thermal excitation
  - ▷ doping with impurities

### 9.3 Photon absorption

- ▶ Photons with energy greater than the band gap  $E_g$  can excite an electron, creating a hole in the valence band and an electron in the conduction band.

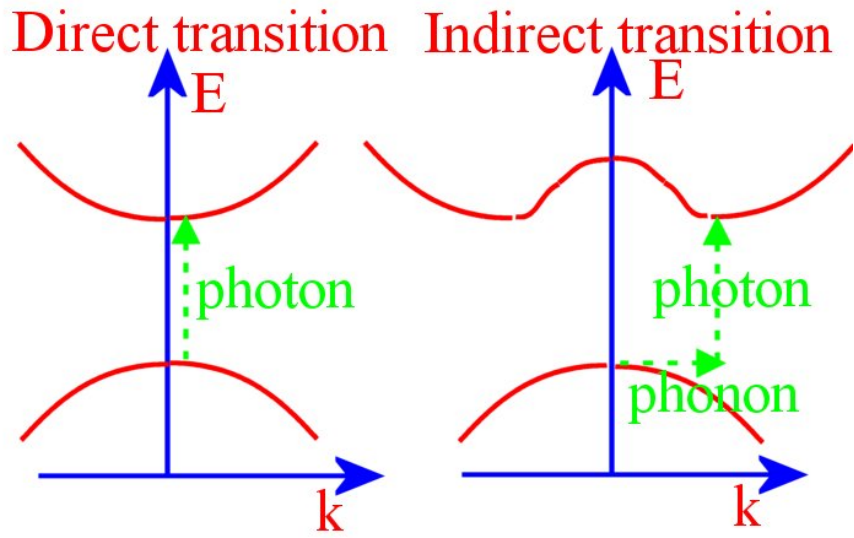

- Note that energy and crystal momentum must be conserved, and a phonon may be emitted or absorbed. In terms of initial electron energy and momentum  $E$  and  $\hbar k$ , final electron state  $(E', k')$ , photon energy and momentum  $\hbar\Omega$  and  $\hbar Q$ , and phonon energy and momentum  $\hbar\omega$  and  $\hbar q$ :

$$E' = E + \hbar\Omega \pm \hbar\omega,$$

and

$$k' = k + Q \pm q.$$

- Note that if the photon energy is about 1 eV its wavelength is about  $1.2 \mu\text{m}$ , so its wavevector is  $5.1 \times 10^6 \text{ m}^{-1}$ . The side of the Brillouin zone is  $2\pi/a$ , which is typically of order  $10^{10} \text{ m}^{-1}$ . On the scale of the reciprocal lattice, then, the photon wavevector is essentially zero – a photon transition is *vertical*.

### 9.4 Thermal excitation

- We can find the number of electrons in the conduction band by taking the density of states in the conduction band,  $g_c(E)$ , multiplying it by the probability that the state is occupied (the Fermi function), and integrating. If the energy of the bottom of the conduction band is  $E_c$  the number of electrons is

$$N_e(T) = \int_{E_c}^{\infty} \frac{g_c(E)dE}{\exp((E - \mu)/(k_B T)) + 1}. \tag{9.1}$$

- Note that
  - ▷  $N_e$  will depend on the temperature
  - ▷ we need to know the chemical potential,  $\mu$ .
- The number of holes depends on the probability that an electron state is unoccupied, but

$$1 - \frac{1}{\exp((E - \mu)/(k_B T)) + 1} = \frac{\exp((E - \mu)/(k_B T))}{\exp((E - \mu)/(k_B T)) + 1} = \frac{1}{\exp((\mu - E)/(k_B T)) + 1},$$

- So the number of holes is

$$N_h(T) = \int_{-\infty}^{E_v} \frac{g_v(E)dE}{\exp((\mu - E)/(k_B T)) + 1}, \tag{9.2}$$

where  $E_v$  is the energy of the top of the valence band and  $g_v(E)$  is the density of states in the valence band.

- Equations 9.1 and 9.2 can be simplified if the numbers of electrons and holes are small. If

$$\frac{1}{\exp((E - \mu)/(k_B T)) + 1} \ll 1,$$

it follows that the exponential is large, so that

$$\frac{1}{\exp((E - \mu)/(k_B T)) + 1} \approx e^{(\mu - E)/(k_B T)},$$

which is true if

$$E - \mu \gg k_B T.$$

- In the conduction band,  $E \geq E_c$ , so the condition is

$$E_c - \mu \gg k_B T. \quad (9.3)$$

- Similarly, provided

$$\mu - E_v \gg k_B T. \quad (9.4)$$

we can write in the valence band

$$\frac{1}{\exp((\mu - E)/(k_B T)) + 1} \approx e^{(E - \mu)/(k_B T)}.$$

- This low carrier density is the *nondegenerate* case.
- The other extreme, in which the probability of occupation of a level is close to 1, is the *degenerate* case, typified by the occupied states in a metal.
- Note that in the nondegenerate case we have been able to replace the Fermi (exact) distribution function with the classical Boltzmann form.

### 9.4.1 Law of mass action

- In the nondegenerate limit,

$$\begin{aligned} N_e(T) &\approx \int_{E_c}^{\infty} g_c(E) e^{(\mu - E)/(k_B T)} dE \\ &= e^{(\mu - E_c)/(k_B T)} \int_{E_c}^{\infty} g_c(E) e^{-(E - E_c)/(k_B T)} dE \\ &= e^{(\mu - E_c)/(k_B T)} N_c(T). \end{aligned} \quad (9.5)$$

- Similarly,

$$\begin{aligned} N_h(T) &\approx \int_{-\infty}^{E_v} g_v(E) e^{(E - \mu)/(k_B T)} dE \\ &= e^{(E_v - \mu)/(k_B T)} \int_{-\infty}^{E_v} g_v(E) e^{-(E_v - E)/(k_B T)} dE \\ &= e^{(E_v - \mu)/(k_B T)} N_v(T). \end{aligned}$$

- $N_c(T)$  and  $N_v(T)$  are only slowly-varying functions of  $T$ .
- We still cannot determine the individual carrier concentrations without knowing  $\mu$ , but if we take the product

$$\begin{aligned} N_e(T) N_h(T) &= e^{(\mu - E_c)/(k_B T)} N_c(T) e^{(E_v - \mu)/(k_B T)} N_v(T) \\ &= e^{(E_v - E_c)/(k_B T)} N_c(T) N_v(T) \\ &= e^{-E_g/(k_B T)} N_c(T) N_v(T). \end{aligned}$$

the result is independent of  $\mu$ .

- This is the *law of mass action*: if we know the number of one of the carriers, we can find that of the other.

## 9.5 Parabolic bands

- ▶ We saw that, near the top and bottom of bands, a parabolic approximation was appropriate, and we can combine this with the effective mass to write, for conduction electrons,

$$E(\mathbf{k}) = E_c + \frac{\hbar^2 |\mathbf{k} - \mathbf{k}_0|^2}{2m_e^*},$$

and in the valence band

$$E(\mathbf{k}) = E_v - \frac{\hbar^2 |\mathbf{k} - \mathbf{k}_0|^2}{2m_h^*}.$$

- ▶ Using, as usual,

$$g(k)dk = 2 \left( \frac{L}{2\pi} \right)^3 4\pi k^2 dk$$

and

$$\frac{dE}{dk} = \frac{\hbar^2 k}{m^*}$$

and noting that the same result is valid whether we expand about  $\mathbf{k} = 0$  or  $\mathbf{k} = \mathbf{k}_0$ , for the conduction band

$$\begin{aligned} g_c(E) &= \frac{L^3}{\pi^2} \frac{m_e^* k}{\hbar^2} \\ &= \frac{V}{\pi^2} \frac{m_e^*}{\hbar^2} \sqrt{\frac{2m_e^*(E - E_c)}{\hbar^2}} \\ &= \frac{V 2^{1/2} (m_e^*)^{3/2}}{\hbar^3 \pi^2} \sqrt{E - E_c}. \end{aligned}$$

- ▶ Similarly, for the valence band,

$$g_v(E) = \frac{V 2^{1/2} (m_h^*)^{3/2}}{\hbar^3 \pi^2} \sqrt{E_v - E}.$$

- ▶ Now we can evaluate the integrals

$$\begin{aligned} N_c(T) &= \int_{E_c}^{\infty} g_c(E) e^{-(E - E_c)/(k_B T)} dE \\ &= \frac{V 2^{1/2} (m_e^*)^{3/2}}{\hbar^3 \pi^2} \int_{E_c}^{\infty} \sqrt{E - E_c} e^{-(E - E_c)/(k_B T)} dE. \end{aligned}$$

- ▶ Substitute  $x = (E - E_c)/(k_B T)$ , to obtain

$$\begin{aligned} N_c(T) &= \frac{V 2^{1/2} (m_e^* k_B T)^{3/2}}{\hbar^3 \pi^2} \int_0^{\infty} \sqrt{x} e^{-x} dx \\ &= \frac{1}{4} V \left( \frac{2m_e^* k_B T}{\pi \hbar^2} \right)^{3/2}, \end{aligned} \tag{9.6}$$

using the standard integral

$$\int_0^{\infty} \sqrt{x} e^{-x} dx = \frac{\sqrt{\pi}}{2}.$$

- ▶ If we set  $V = 1$ , we can work with concentrations of carriers  $n_{e,h}$  and corresponding values  $n_{c,v}$ .
- ▶ If we put in numbers, we find

$$n_c(T) = 5 \times 10^{21} \left( \frac{m_e^*}{m_e} \right)^{3/2} T^{3/2}.$$

- The expression for the valence band is quite similar:

$$n_v(T) = \frac{1}{4} \left( \frac{2m_h^* k_B T}{\pi \hbar^2} \right)^{3/2}.$$

## 9.6 Intrinsic behaviour

- If all (or almost all) the electrons in the conduction band have been excited from the valence band, we have

$$n_e(T) = n_h(T) = n_i(T),$$

with

$$\begin{aligned} n_i(T) &= e^{-E_g/(2k_B T)} \sqrt{n_c(T) n_v(T)} \\ &= e^{-E_g/(2k_B T)} \frac{1}{4} \left( \frac{2k_B T}{\pi \hbar^2} \right)^{3/2} (m_e^* m_h^*)^{3/4} \\ &= 5 \times 10^{21} \left( \frac{m_e^* m_h^*}{m_e^2} \right)^{3/4} T^{3/2} e^{-E_g/(2k_B T)}. \end{aligned} \quad (9.7)$$

- Now we can find the Fermi energy: if we equate the value for  $n_e(T)$  from equations 9.5 and 9.6 with that from 9.7 we find

$$e^{-E_g/(2k_B T)} \frac{1}{4} \left( \frac{2k_B T}{\pi \hbar^2} \right)^{3/2} (m_e^* m_h^*)^{3/4} = \frac{1}{4} \left( \frac{2m_e^* k_B T}{\pi \hbar^2} \right)^{3/2} e^{(\mu - E_c)/(k_B T)},$$

then

$$\mu = E_c - \frac{1}{2} E_g + \frac{1}{2} k_B T \ln \left( \frac{n_v}{n_c} \right).$$

- Knowing the relationship between  $n_{c,v}$  and  $m_{e,h}^*$ , we also have

$$\mu = E_c - \frac{1}{2} E_g + \frac{3}{4} k_B T \ln \left( \frac{m_h^*}{m_e^*} \right).$$

- At  $T = 0$ ,  $\mu$  lies half-way between the valence and conduction bands
- As  $T$  increases,  $\mu$  will move towards the band with the smaller effective mass (smaller density of states at the band edge)
- As the effective masses are generally of similar magnitude,  $\mu$  does not move far from mid-gap

- Note that

- ▷  $E_G$  is typically about 1 eV, which is large compared with  $k_B T$  which is 1/40 eV at room temperature
- ▷  $\ln \left( \frac{m_h^*}{m_e^*} \right)$  is of order 1
- ▷ So  $E_c - \mu$  is large compared with  $k_B T$
- ▷ So we are in the nondegenerate regime

- Note that the number of carriers varies as  $e^{-E_g/(2k_B T)}$ , not as  $e^{-E_g/(k_B T)}$  (think of carriers being excited from the chemical potential, not from valence to conduction band)

- The exponential form holds irrespective of the details of the band shapes (i.e. we do not need to assume they are parabolic).

### 9.7 Doping - donors and acceptors

- ▶ Consider doping a 4-valent semiconductor (Si, Ge) with a 5-valent impurity (P, As, Sb).
- ▶ The impurity will *substitute* for a host atom, so that 4 of its 5 valence electrons are involved in bonds to its neighbours.

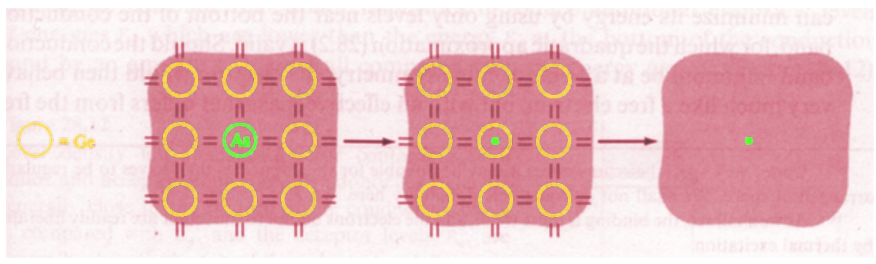

- ▶ This leaves one electron unaccounted for, but the impurity nucleus has one extra positive charge to attract it.

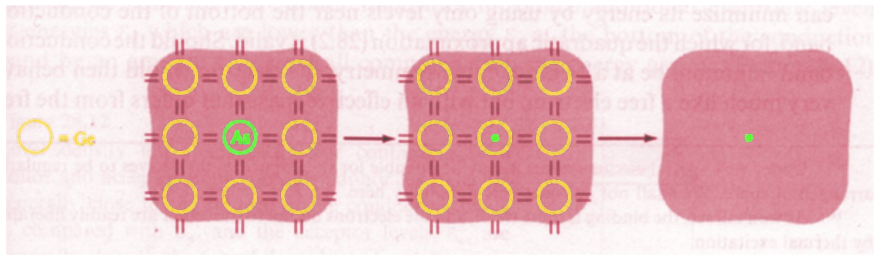

- ▶ Assume
  - ▷ The extra electron is quite loosely bound to the impurity
  - ▷ To a first approximation it is an electron in the conduction band with energy  $E_c$  and is spread out over the crystal

- ▷ Its mass is the electronic *effective* mass  $m_e^*$
- ▷ Also it sees the nucleus through the crystal, screened by the dielectric constant  $\epsilon_r$

#### 9.7.1 Impurity states

- ▶ The Hamiltonian for the extra electron of a 5-valent impurity is

$$\mathcal{H} = -\frac{\hbar^2}{2m_e^*} \nabla^2 - \frac{e^2}{4\pi\epsilon_r\epsilon_0 r}$$

which is just like the Hydrogen atom Hamiltonian

$$\mathcal{H} = -\frac{\hbar^2}{2m_e} \nabla^2 - \frac{e^2}{4\pi\epsilon_0 r}$$

except with a scaled mass and with  $\epsilon_0$  replaced by  $\epsilon_0\epsilon_r$ .

- ▶ If we take over the Hydrogen atom energies and wavefunctions,

$$E_n = -\frac{e^4 m_e}{32\pi^2 \epsilon_0^2 \hbar^2} \frac{1}{n^2} = -\frac{13.6}{n^2} \text{ eV}$$

and for the ground state

$$\psi(r) = N e^{-r/a_H}$$

where  $a_H$  is the Bohr radius,

$$a_H = \frac{4\pi\epsilon_0 \hbar^2}{e^2 m_e} = 0.053 \text{ nm.}$$

- ▶ Putting in the scaling factors, the impurity binding energy in its ground state is

$$E = -13.6\text{eV} \frac{(m_e^*/m_e)}{\epsilon_r^2},$$

with a radius

$$a_0 = a_H \frac{\epsilon_r}{(m_e^*/m_e)}$$

- ▶ If we take  $m_e^* = 0.2m_e$  and  $\epsilon_r = 11.7$  for Si we find

$$a_0 = 3 \text{ nm}$$

which is many interatomic spacings – consistent with our initial assumption that the electron samples a large region of the crystal.

- ▶ The binding energy in Si is then

$$E = -0.02 \text{ eV},$$

which, remember, is the lowering of energy relative to the bottom of the conduction band,

$$E_d = E_c + E.$$

- ▶ As it is easy to excite electrons from these loosely-bound states into the conduction band, 5-valent impurities are called *donors*.
- ▶ Similarly, for 3-valent impurities we have a loosely-bound hole, in energy levels just above the valence band. These are called *acceptor* levels.

- ▶ Far-infrared absorption of P in Si showing hydrogen-like transitions between  $n=1$  ground state and higher levels.

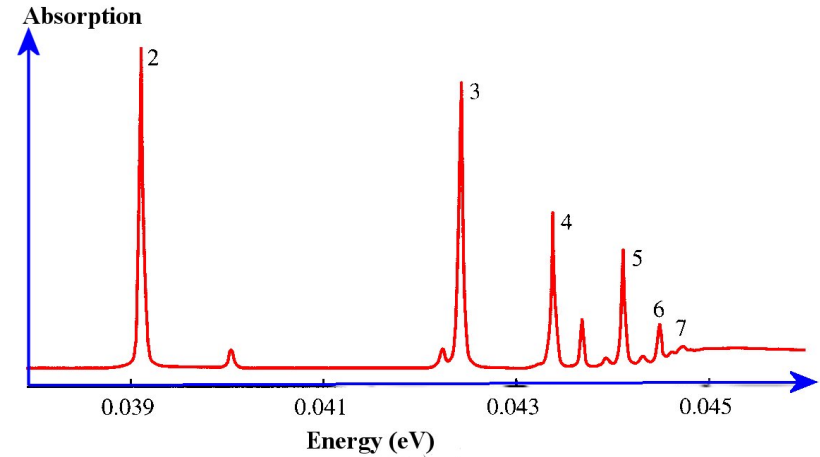

- ▶ We ignore this level structure from now on, and concentrate on the impurity ground state and the nearest band.

### 9.7.2 Typical binding energies

- ▶ From experiment:

Donor ionization energies, meV			
	P	As	Sb
Si	45.0	49.0	39.0
Ge	12.0	12.7	9.6
Acceptor ionization energies, meV			
	B	Al	Ga
Si	45.0	57.0	65.0
Ge	10.4	10.2	10.8



- ▶ Note that there is a small chemical effect.
- ▶ Donor and acceptor states are usually localised, but if the defects get close enough for their wavefunctions to overlap appreciably, we may get *impurity bands*.

**9.7.3 Deep traps**

- ▶ Impurities with larger differences in valence from the host typically produce states which are much further from the band edges – called *deep levels*.
- ▶ These take more thermal energy to release carriers, so are less important in determining carrier concentrations.
- ▶ However, they can trap free carriers and allow them to interact with carriers of the opposite type, allowing *recombination*.
- ▶ The maintenance of the carrier density is a dynamic process, with a balance between thermal excitation and recombination. The recombination time  $\tau$  is an important parameter of semiconductor devices, as we shall see later.

**9.7.4 Locating the chemical potential**

- ▶ In an undoped material, we have seen that at absolute zero, where the Fermi function is a step function, the chemical potential is in the middle of the band gap.

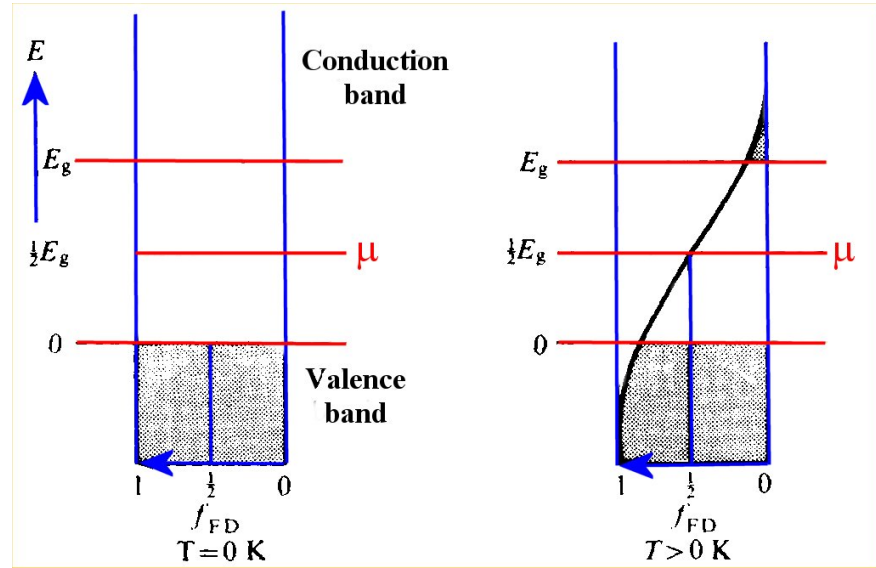

- ▶ As we increase the temperature, it only moves slightly – at the same time the step in the Fermi function broadens out, and in the bands the function is well approximated by a Boltzmann form.
- ▶ If we dope with donors only (*n-type doping*), then at absolute zero the highest occupied levels will be the donor levels, the lowest empty levels will be at the bottom of the conduction band, so the chemical potential will lie between the donor levels and the bottom of the conduction band (left picture).

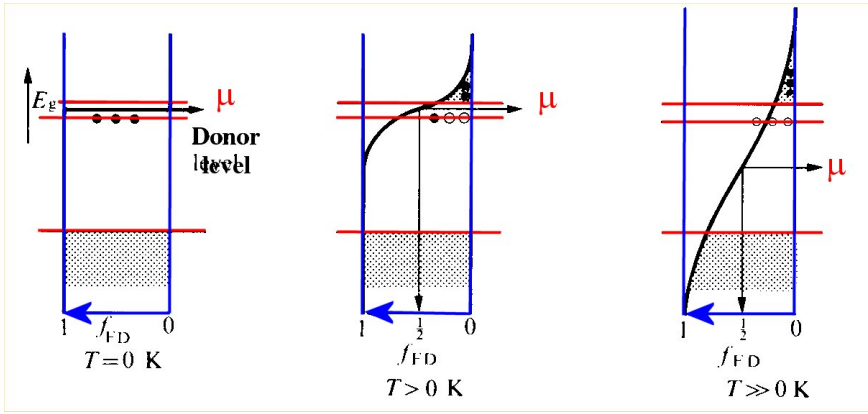
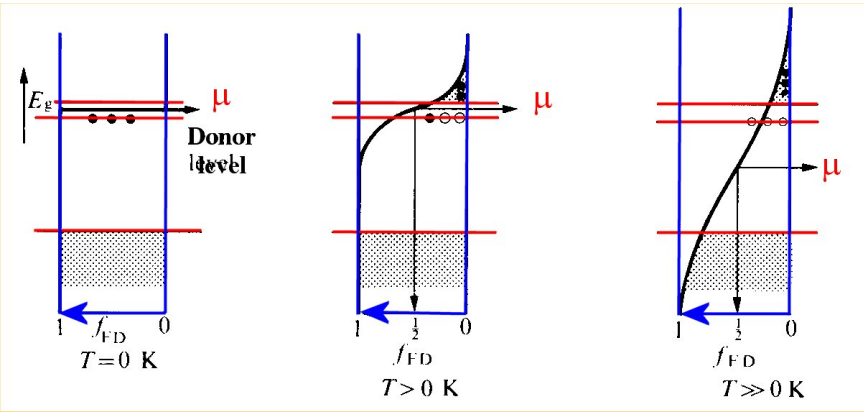

- If we raise the temperature slightly, we excite electrons from the donor levels into the conduction band (centre picture).

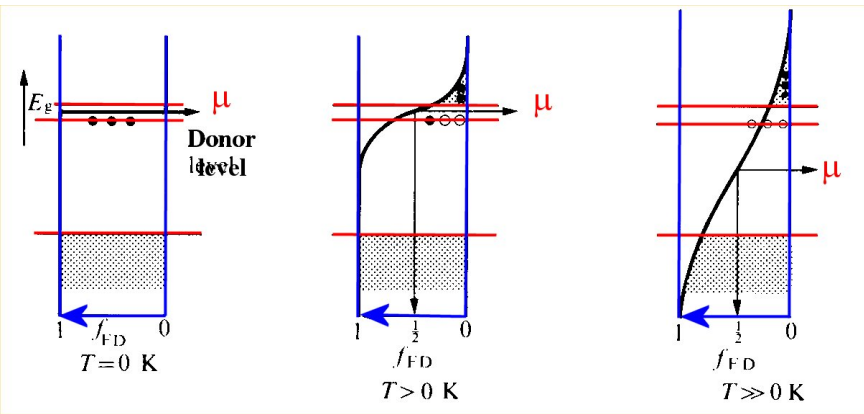

- As we raise the temperature more, we will exhaust the donor levels. Any further electrons must come from the valence band (right-hand picture)

- We are then back in the *intrinsic* regime.
- Note that no matter how hard we try, we can *never* have *only* donors in the system - there are bound to be some acceptors.
- The electronic energies for the acceptors are lower than those for the donors, so the few acceptors will ionize a few donors so the boundary between occupied and unoccupied levels lies somewhere amongst the donor levels. At very low  $T$  the chemical potential is 'pinned' at the donor levels in this case.

## 9.8 Carrier concentrations

### 9.8.1 Overview

- Consider the electron density in an n-type semiconductor:

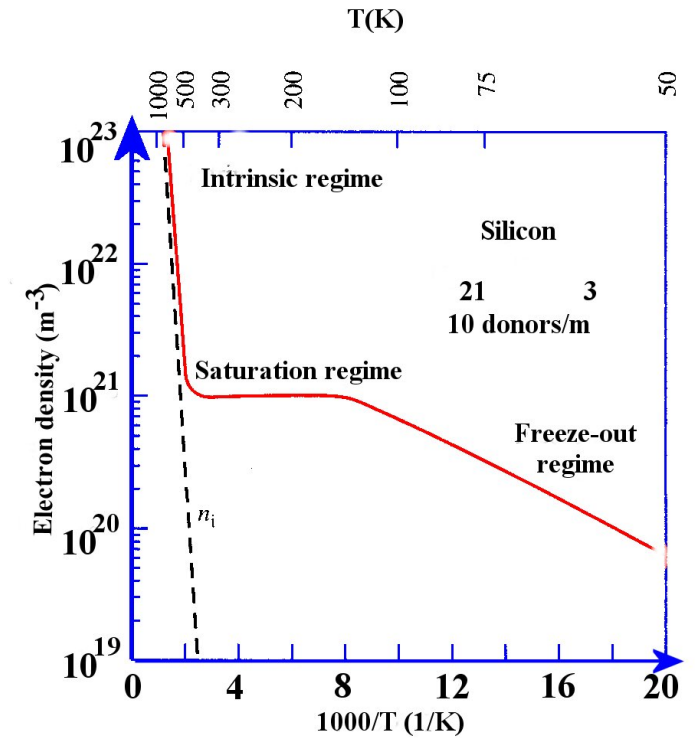
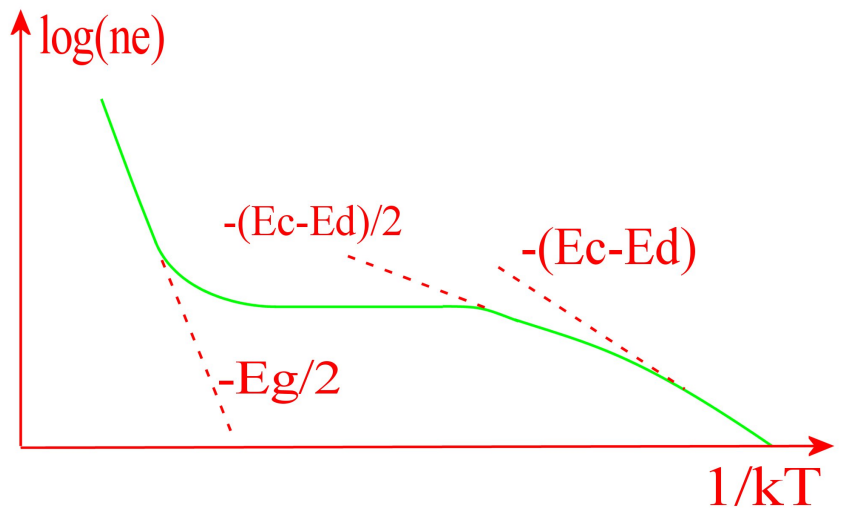

- ▶ At very low  $T$ ,  $n_e \propto e^{-(E_c - E_d)/(k_B T)}$  (pinned  $\mu$ );
- ▶ At low  $T$  ( $k_B T$  comparable with impurity binding energy)  $n_e \propto e^{-(E_c - E_d)/(2k_B T)}$  ( $\mu$  between donor level and the conduction band).
- ▶ At intermediate  $T$  we exhaust all the impurities, but have not enough thermal energy to excite from the valence band – *saturation*
- ▶ At higher  $T$  we have  $n_e \propto e^{-E_g/(2k_B T)}$ .

- ▶ Note that  $n_e(T)n_h(T) = e^{-E_g/(k_B T)}n_c(T)n_v(T)$  *irrespective of doping*.
- ▶ At room temperatures,  $n_e, n_h \approx 10^{38} \text{ m}^{-6}$  for Ge and  $10^{33} \text{ m}^{-6}$  for Si, so if there is no doping,  $n_e = n_h \approx 3 \times 10^{16} \text{ m}^{-3}$  for Si.
- ▶ So to observe intrinsic behaviour at room temperature, need fewer carriers than this from impurities, a *concentration* of less than one part in  $10^{12}$  of  $10^{13}$ , which is unachievable.

### 9.8.2 Detailed results

- ▶ At low temperatures, in an n-type material, if there are  $n_D$  donors per volume, we know that the number of ionized donors will be

$$n_D^+ = n_D \left[ 1 - \frac{1}{\exp((E_D - \mu)/(k_B T)) + 1} \right],$$

i.e. we compute the probability that the donor states will be empty.

- ▶ If we can assume that both

$$\mu - E_D \gg k_B T$$

and

$$E_c - \mu \gg k_B T$$

we can again use the Boltzmann expressions.

- ▶ But these require that  $\mu$  lies between the donor levels and the conduction band, and these are only a few tens of meV apart, so this is only applicable at low  $T$ . Then

$$n_e = \sqrt{n_D n_c(T)} e^{-(E_c - E_D)/(2k_B T)}.$$

## 9.9 Mobility and conductivity

- ▶ If both electrons and holes are present, both contribute to the electrical conductivity:

$$\sigma = n_e e \mu_e + n_h e \mu_h.$$

- ▶ In a doped material, one carrier type will be present in larger number at room temperatures – the *majority carrier*.
- ▶ The other is the *minority carrier*.
- ▶ At high  $T$ , the material behaves *intrinsically*, with roughly equal concentrations of electrons and holes.
- ▶ The main factors affecting the mobilities are scattering by charged impurities and phonon scattering. The real temperature dependences are complicated, but one can make rough estimates.

### 9.9.1 Scattering by charged impurities

- ▶ Assume that a carrier is scattered when its potential energy in the field of the scatterer is similar to its kinetic energy.
- ▶ The potential energy, Coulombic, at a distance  $r$

$$V \propto \frac{1}{r}.$$

- ▶ The kinetic energy is thermal energy,

$$E \propto T$$

- ▶ So we can define an effective radius of the scatterer as

$$r_s \propto \frac{1}{T}.$$

- ▶ Hence we get a scattering cross-section, and a scattering probability,

$$p_{\text{scatt}} \propto \pi r_s^2 \propto T^{-2}.$$

- ▶ The rate at which the carrier encounters scatterers is proportional to the carrier velocity

$$v \propto \sqrt{T},$$

- ▶ So overall

$$p_{\text{scatt}} \propto T^{-3/2}.$$

**9.9.2 Scattering by phonons**

- ▶ As in metals, the probability of interacting with a phonon is proportional to the number of phonons, which is proportional to  $T$  at room temperature.
- ▶ But the rate at which the carriers pass through the crystal is determined by their thermal velocity,

$$v \propto \sqrt{T},$$

so

$$p_{\text{scatt}} \propto T^{3/2}.$$

- ▶ Note the difference from metals – there the velocity of the carriers being scattered was the Fermi velocity, essentially independent of  $T$ .

**9.9.3 Overall effect**

- ▶ The graph shows the variation of the two contributions to  $1/\tau$ , and as usual

$$\frac{1}{\tau} = \frac{1}{\tau_{\text{def}}} + \frac{1}{\tau_{\text{phon}}}.$$

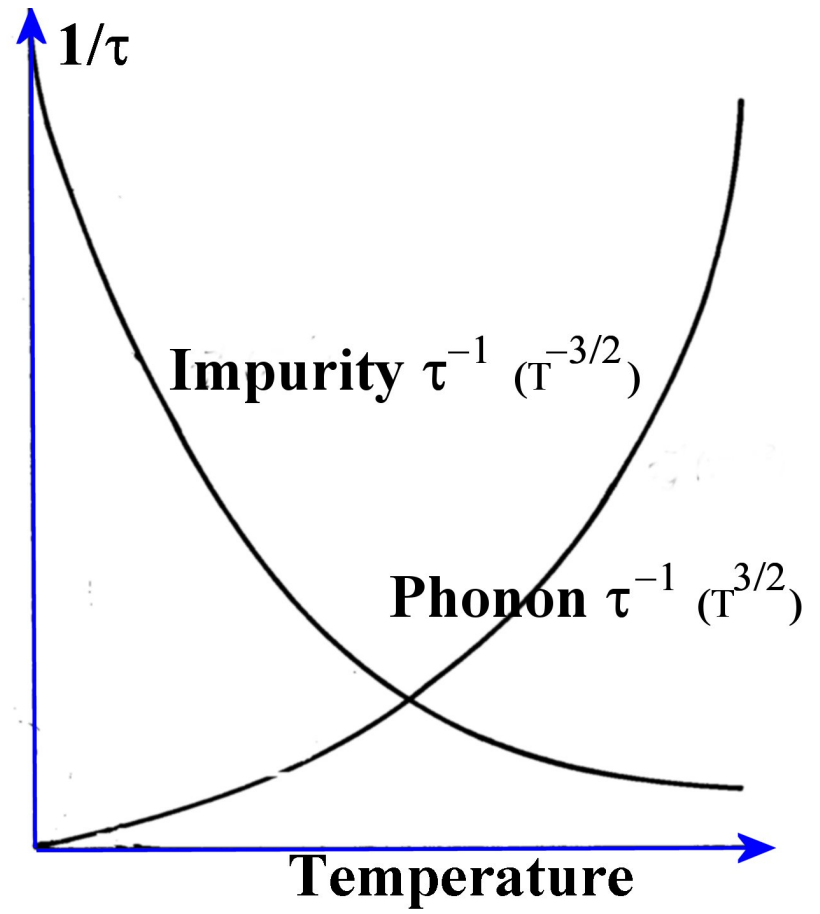

- ▶ So the mobility peaks at intermediate temperatures – typically 100 to 200 K.
- ▶ Then, to find the conductivity, we need to factor in the number of carriers, giving the result in the following graph.

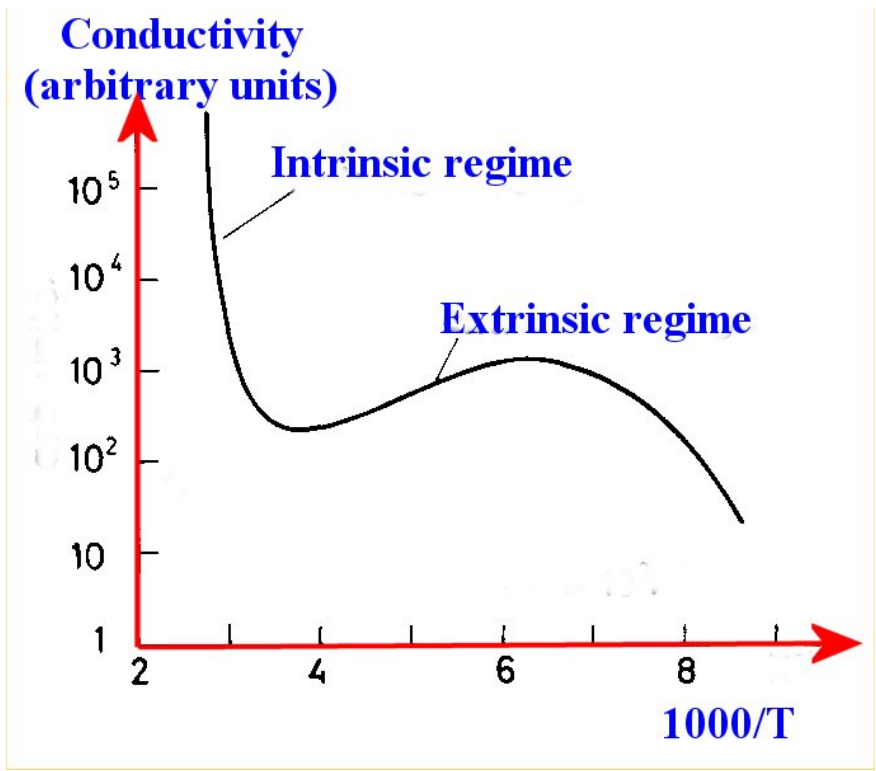

- ▷ at high  $T$ , intrinsic behaviour gives  $n_e = n_h$ , but  $\mu_e > \mu_h$  so  $R_H < 0$
  
- ▷ temperature dependence of carrier concentration gives exponential dependence of  $R_H$  at high  $T$

**9.9.4 Hall effect in semiconductors**

► With more than one carrier type, the Hall coefficient is

$$R_H = \frac{1}{|e|} \frac{n_h \mu_h^2 - n_e \mu_e^2}{(n_h \mu_h + n_e \mu_e)^2}$$

► For a doped semiconductor, it is possible for the sign of the Hall coefficient to vary with  $T$ : for example, consider a p-type material with  $\mu_e > \mu_h$

▷ at low  $T$ ,  $R_H > 0$

► *Example:* Hall coefficient in InSb.

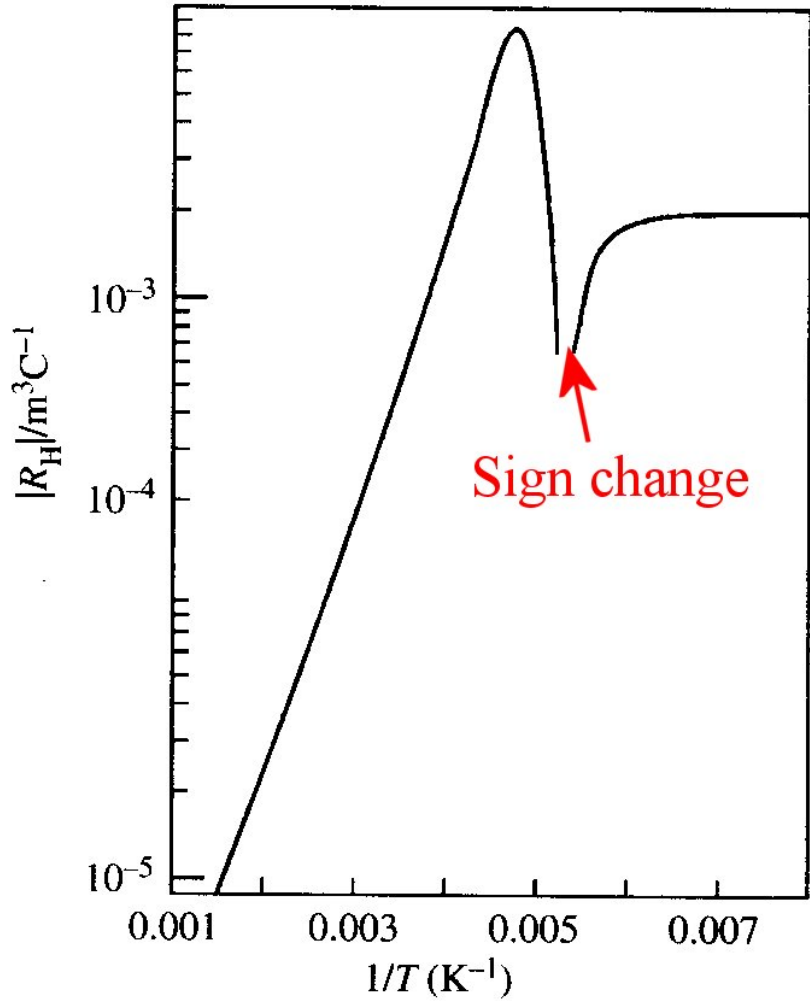

**9.9.5 Cyclotron resonance**

- ▶ In stronger magnetic fields  $\mathcal{B}$ , the carriers move in spirals about the field lines. For holes for example,

$$\frac{m_h^* v^2}{r} = \mathcal{B} e v,$$

so that the angular frequency  $\omega_c = v/r$  is

$$\omega_c = \frac{e\mathcal{B}}{m_h^*}.$$

- ▶ This is the *cyclotron frequency*: electromagnetic radiation of that frequency can be absorbed, giving a measurement of  $m_h^*$ .
- ▶ We do not expect to be able to detect this cyclotron resonance unless the carrier completes most of an orbit before being scattered,

$$\omega_c \tau \sim 1.$$

- ▶ This dictates the range of frequency, and hence field, to use. Typically at room  $T$  use infrared, at liquid helium  $T$  use microwaves.

- ▶ Cyclotron resonance in Si at 24 GHz at 4 K.

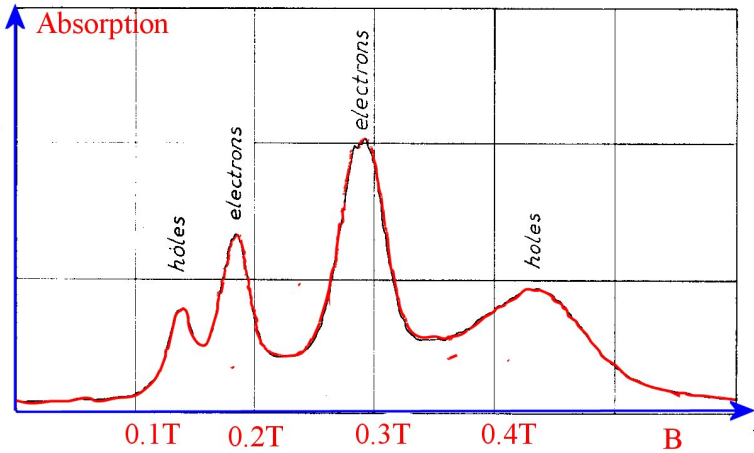

- ▶ Note that we have heavy holes and light holes, but for electrons the constant energy surfaces are ellipsoids, so the effective mass is different for different directions.
- ▶ There is a vast array of beautiful experiments which explore details of Fermi surfaces, which we have no time to explore in this course.

### 9.10 Carrier diffusion and recombination

- ▶ Suppose we have a p-type semiconductor, i.e.
 
$$n_h \gg n_e. \tag{9.8}$$
- ▶ Create a local excess of minority carriers (electrons)
  - ▷ with radiation, when  $\Delta n_e = \Delta n_h$  automatically, or

- ▷ by using a contact, when electrical neutrality will ensure  $\Delta n_e = \Delta n_h$ .
- ▶ But because of equation 9.8
 
$$\frac{\Delta n_e}{n_{e0}} \gg \frac{\Delta n_h}{n_{h0}},$$
 so the change from equilibrium concentration ( $n_{e0}$  or  $n_{h0}$ ) is much greater for the minority carriers.

#### 9.10.1 Recombination

- ▶ Electrons and holes annihilate, mainly at deep traps or surfaces.
- ▶ The recombination (annihilation) rate is proportional to the product of the concentrations:

$$R' = cn_e n_h = c(n_{e0} + \Delta n_e)(n_{h0} + \Delta n_h).$$

- ▶ But we know that in equilibrium we have dynamic equilibrium with thermal generation equal to recombination  $cn_{e0}n_{h0}$ , so the recombination caused by the *excess* carriers is

$$\begin{aligned} R &= c(n_{e0} + \Delta n_e)(n_{h0} + \Delta n_h) - cn_{e0}n_{h0} \\ &= cn_{e0}n_{h0} \left( \frac{\Delta n_e}{n_{e0}} + \frac{\Delta n_h}{n_{h0}} + \frac{\Delta n_h}{n_{h0}} \frac{\Delta n_e}{n_{e0}} \right) \\ &\approx cn_{e0}n_{h0} \frac{\Delta n_e}{n_{e0}}, \end{aligned}$$

keeping only the largest term. Thus

$$R = n_{h0} \Delta n_e,$$



and the recombination rate is proportional to the concentration of excess minority carriers.

► If we write

$$R = -\frac{d\Delta n_e}{dt} = \frac{\Delta n_e}{\tau_e},$$

then

$$\Delta n_e(t) = \Delta n_e(0)e^{-t/\tau_e}.$$

### 9.10.2 Diffusion

► Suppose we inject excess minority carriers at some point: this will set up a carrier concentration gradient, and carriers will diffuse. As they carry charge, this will give an electric current density. For holes

$$J = -|e|D_h \nabla n_h,$$

the negative sign accounting for diffusion *down* the gradient.  $D_h$  is the diffusion constant.

► The rate of increase of hole density in a slice at  $x$  in one dimension is

$$\frac{\partial}{\partial x} \left( -D_h \frac{\partial n_h}{\partial x} \right) = -D_h \frac{\partial^2 n_h}{\partial x^2},$$

which in a steady state is balanced by recombination loss so

$$D_h \frac{\partial^2 n_h}{\partial x^2} = \frac{n_h - n_{h0}}{\tau_h}.$$

► This is equivalent to

$$\frac{\partial^2 \Delta n_h}{\partial x^2} = \frac{\Delta n_h}{D_h \tau_h}$$

or

$$\Delta n_h(x) = \Delta n_h(0)e^{-x/l_h},$$

where

$$l_h = \sqrt{D_h \tau_h}$$

is called the *hole diffusion length*.

- Of course, for electrons there are exactly similar expressions.
- Note that the diffusion constant and the mobility are related by the *Einstein relations*

$$\mu_h = \frac{eD_h}{k_B T} \quad \mu_e = \frac{eD_e}{k_B T}.$$

### 9.10.3 Electric current

► In general, there can be four contributions to electric current in a semiconductor:

1. electron drift:  $J_{e,\text{drift}} = n_e \mu_e |e| \mathcal{E}$
2. hole drift:  $J_{h,\text{drift}} = n_h \mu_h |e| \mathcal{E}$
3. electron diffusion:  $J_{e,\text{diff}} = |e| D_e \nabla n_e$
4. hole diffusion:  $J_{h,\text{diff}} = -|e| D_h \nabla n_h$

Carrier mobilities, $\text{m}^2\text{V}^{-1}\text{s}^{-1}$ at room $T$					
	Electrons	Holes		Electrons	Holes
Diamond	0.018	0.012	GaAs	0.080	0.003
Si	0.014	0.005	GaSb	0.050	0.010
Ge	0.036	0.018	PbS	0.006	0.006
InSb	0.300	0.005	PbSe	0.010	0.009
InP	0.045	0.001	AlSb	0.009	0.004

### 9.11 Heterojunctions

- ▶ Most important semiconductor devices depend on having differently-doped materials in contact.
- ▶ In practice, these are made by ion implantation or diffusion, giving relatively smooth dopant concentration variations – but we assume sharp boundaries.
- ▶ Consider an n-type and a p-type material.

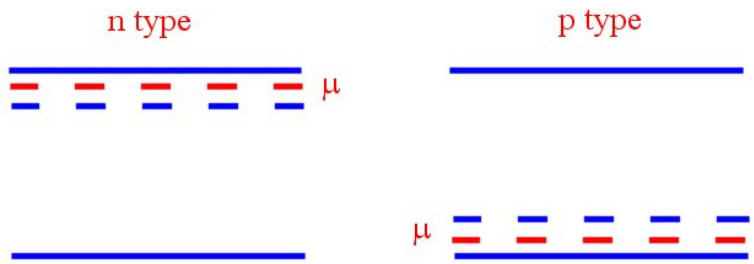
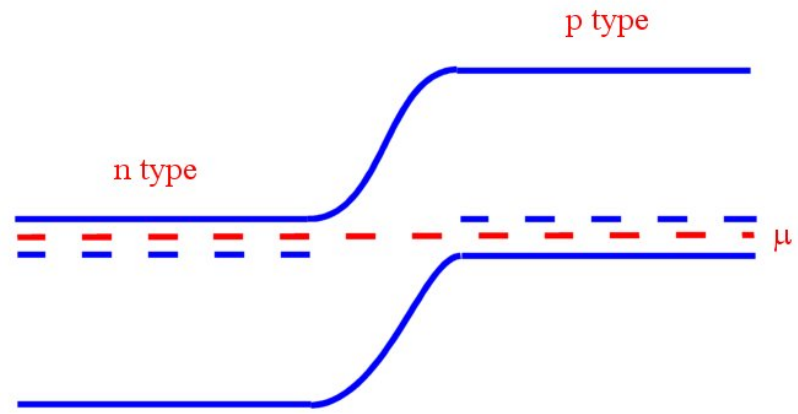

- ▶ When they are separated, their chemical potentials are roughly  $E_g$  apart. When they are in contact and in equilibrium the chemical potential must be constant throughout.

- ▶ This can happen if the p-type region becomes negative, raising the potential for electrons, and the n-type becomes positive.

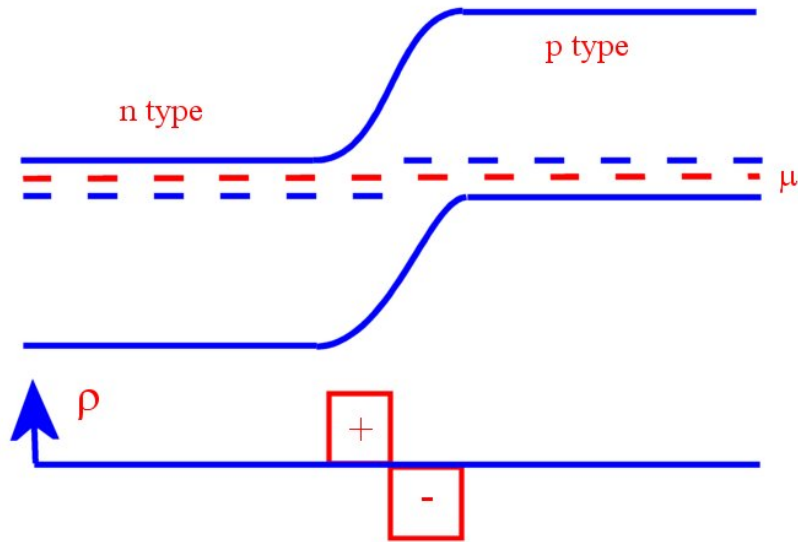

- ▶ We assume this happens by ionising the impurities: the electrons released from donors in a region near the interface go to acceptors near the interface.
- ▶ Suppose a region of thickness  $x_D$  with donor density  $n_D$  and a region of thickness  $x_A$  with acceptor density  $n_A$  are ionised.
- ▶ The ionisation is assumed to be total within this *depletion zone*, where there are practically no free carriers.
- ▶ In a region with charge density  $\rho$  Poisson's equation tells us the electric field is given by

$$\frac{d\mathcal{E}}{dx} = \frac{\rho}{\epsilon_0\epsilon_r}.$$

- ▶ If the field is zero outside the depletion zone,  $\mathcal{E} = 0$  at  $x = -x_D$ , and in the depletion zone in the n-type material  $\rho = |e|n_D$ , so

$$\mathcal{E} = \frac{n_D|e|}{\epsilon_0\epsilon_r}(x + x_D).$$

- ▶ As the potential  $\mathcal{V}$  is related to the field by  $\mathcal{E} = -d\mathcal{V}/dx$  we have

$$\mathcal{V} = V(-x_D) - \frac{n_D|e|}{2\epsilon_0\epsilon_r}(x + x_D)^2.$$

- ▶ Similarly in the p-type depletion zone

$$\mathcal{E} = \frac{n_A|e|}{\epsilon_0\epsilon_r}(x_A - x),$$

- ▶ We have a total change in potential across the depletion region

$$\Delta\mathcal{V} = \frac{|e|}{2\epsilon_0\epsilon_r} (n_Dx_D^2 + n_Ax_A^2).$$

- ▶ This must give a voltage equal to the band gap.
- ▶ Putting  $n_Dx_D = n_Ax_A$  (which ensures continuity of  $\mathcal{V}$  at the interface) we find

$$x_D = \sqrt{\frac{2\epsilon_0\epsilon_r}{n_D|e|}\Delta V \left(\frac{n_A}{n_A + n_D}\right)},$$

- ▶ With a band gap of 0.5 V and dopant concentrations of about  $10^{23} \text{ m}^{-3}$ , the depletion layer width is about 1  $\mu\text{m}$ .
- ▶ The charge densities, fields, and potential are shown below.

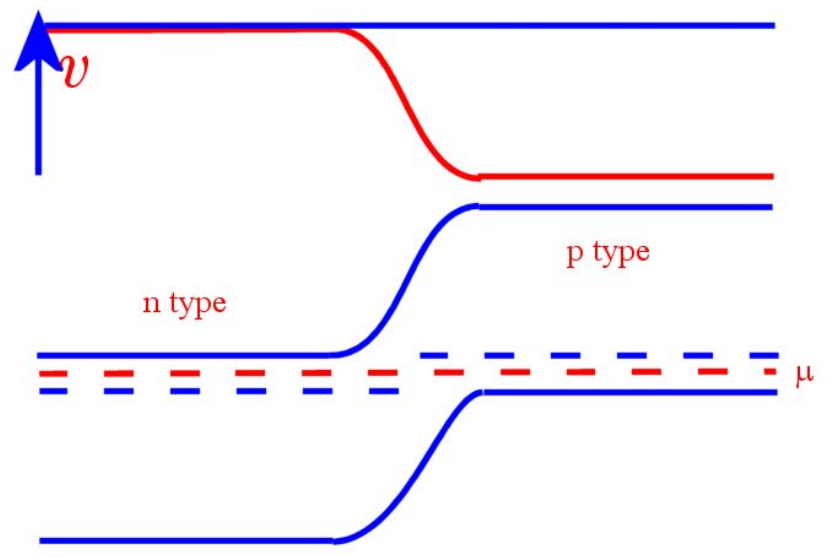
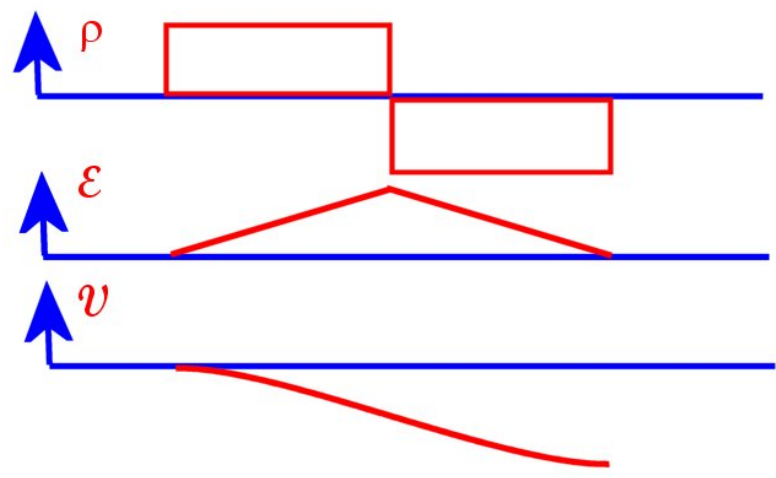

► Here is the relationship between the potential through the junction and the band structure.

- In equilibrium, we can assume there are practically no electrons on the p-type side.
- On the n-type side the fraction of the electrons with enough energy to move to the p-type side will vary as  $\exp(-E_g/k_B T)$  (those with energy  $E_g$  above the bottom of the conduction band.)

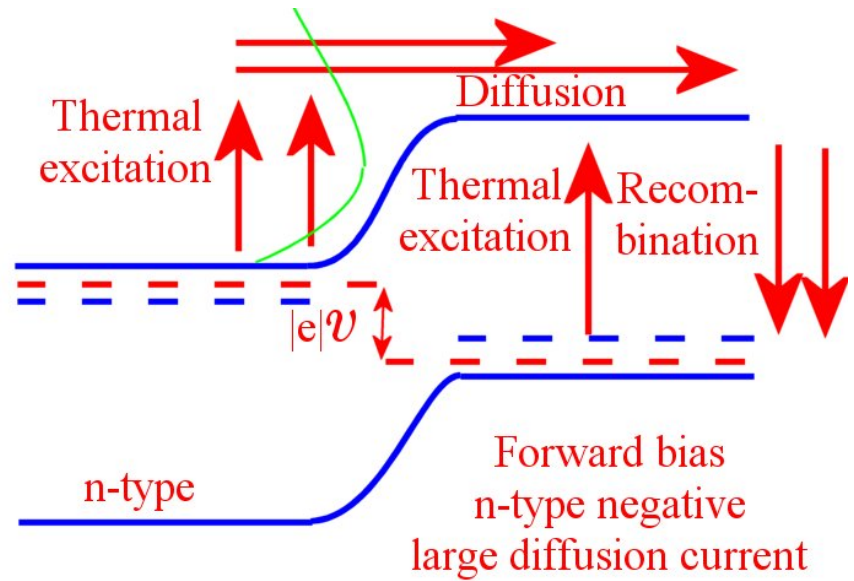
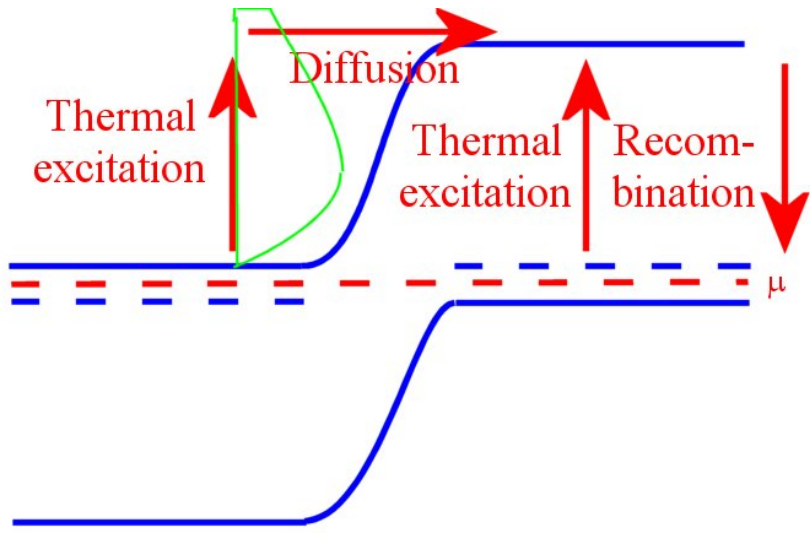

- ▶ Once they are in the p-type material, these diffuse a distance  $l_e$  before they recombine.
- ▶ In equilibrium, these are balanced by a flow of thermally-generated electrons in the p-type region, which roll down the potential energy surface into the n-type region.

- ▶ If you forward bias the junction, raising the energy of the electrons in the n-type region by  $e\mathcal{V}$ , and the number passing from n to p is increased by a factor  $\exp(e\mathcal{V}/k_B T)$ .
- ▶ Under reverse bias, the number of electrons flowing from n to p is reduced, and as there are hardly any electrons in the p-type the reverse current is very low.

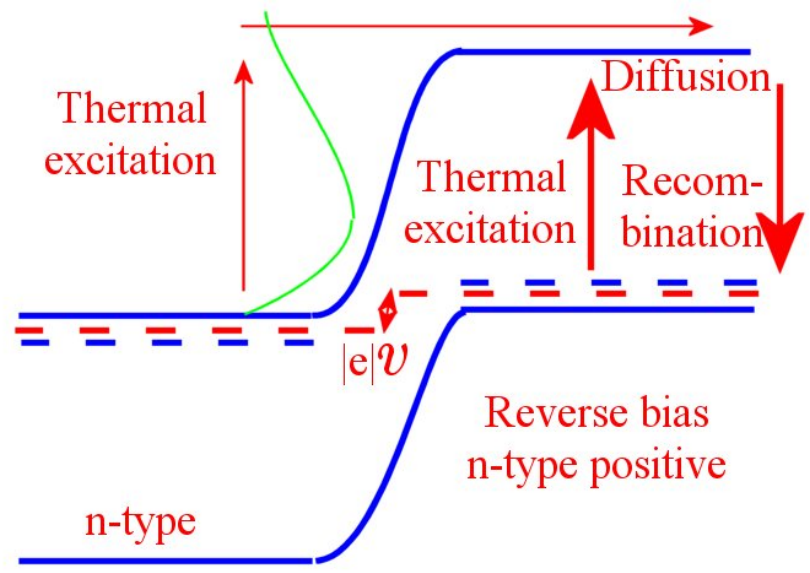

- ▶ Thus the number of electrons very close to the junction on the p-type side will be

$$n_{e0p} + An_{e0p} \left[ e^{eV/k_B T} - 1 \right],$$

where  $A$  is a diffusion parameter from p to n.

- ▶ The extra concentration of electrons on the p side varies as

$$\Delta n_e(x) = \Delta n_e(0)e^{-x/l_e},$$

and the current is given by the product of the diffusion constant and the concentration gradient, so for forward bias

$$J = \frac{eD_eAn_{e0p}}{l_e} \left[ e^{eV/k_B T} - 1 \right],$$

and for reverse bias

$$J = \frac{eD_eAn_{e0p}}{l_e} \left[ 1 - e^{eV/k_B T} \right].$$

- ▶ Of course, the electrons crossing the barrier will be supplied by a drift current in the n-type material. There will be a hole diffusion current in the n-type material too.
- ▶ The p-n junction is a *rectifier*.

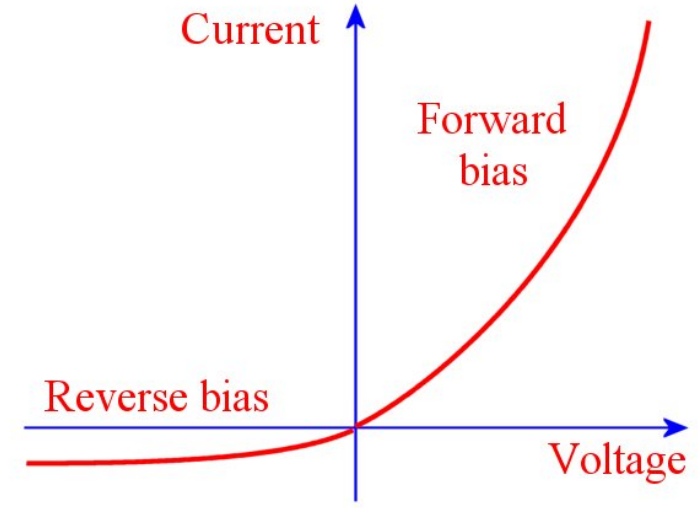

In the diode, there is a change through the barrier region in what carriers dominate the current flow:

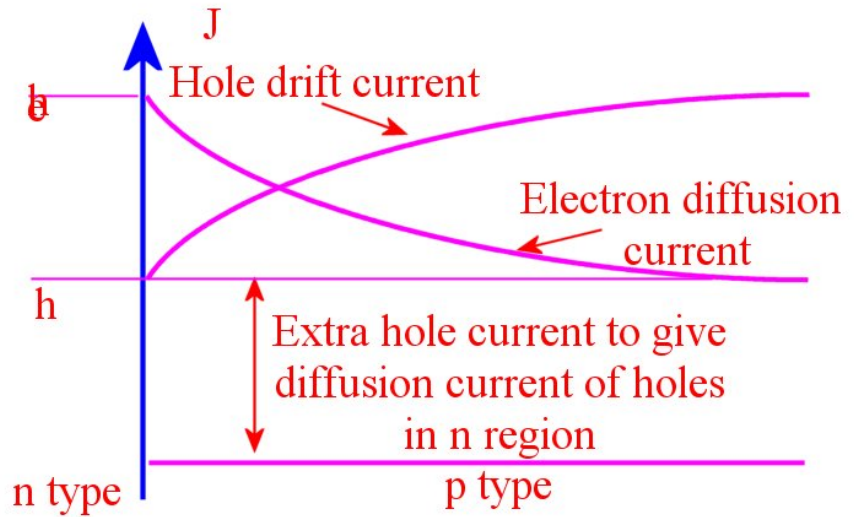

Typical diffusion length,  $l_e$  or  $l_h$ , is about 1 mm, much larger than the width of the depletion zone (about  $1 \mu\text{m}$ ).

**9.11.1 Junction transistor**

- ▶ The junction transistor is two diodes stuck back-to-back (either npn or pnp).

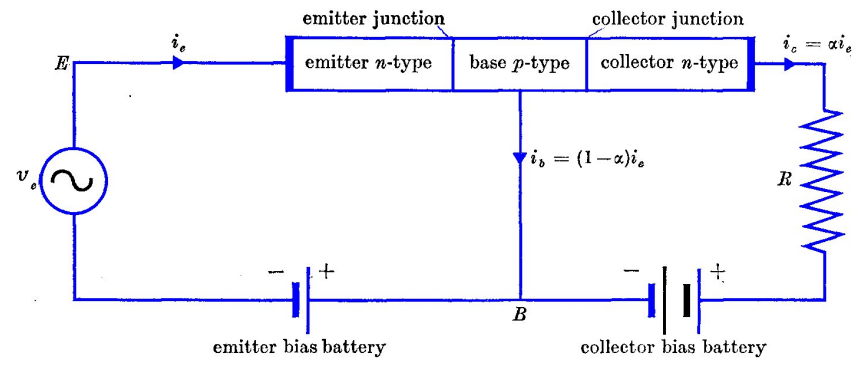

- ▶ The signal voltage  $v_s$  added to the emitter voltage alters the current through the collector, giving an amplified voltage across the load resistance  $R$ .

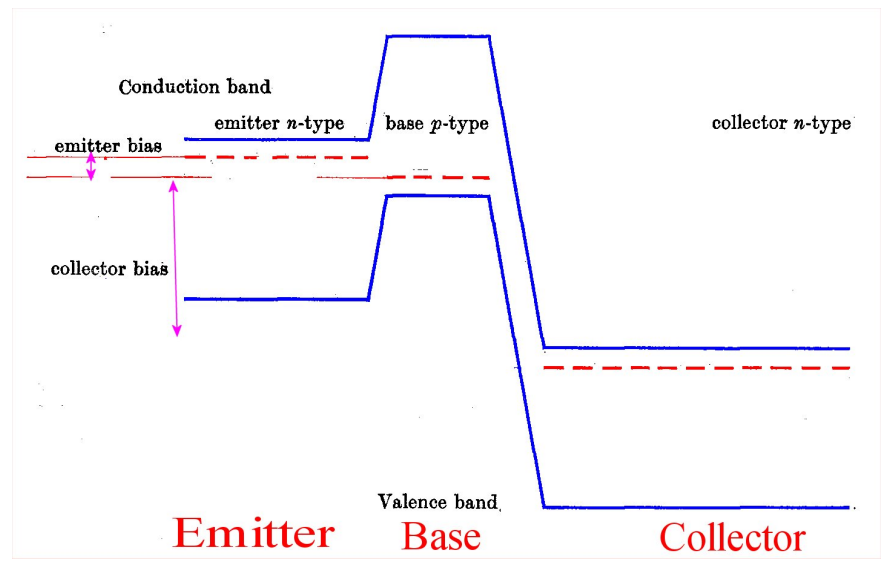

- ▶ Any change in base-emitter voltage causes a large change in the electron current injected into the base.
- ▶ Most of these electrons flow on into the collector.

### 9.11.2 Field effect transistor

- ▶ We can influence carrier densities in a material by applying a potential: here is a Metal-Insulator-Semiconductor (or Metal-Oxide-Semiconductor, MOS) system.

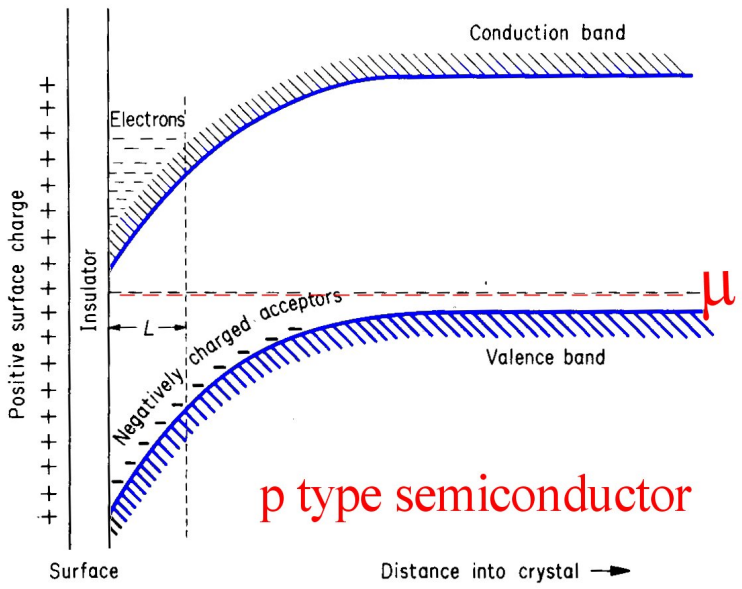

- ▶ That is, with a voltage we can induce a density of *free electrons* in p-type material, called an *inversion region*. The band bending effects are from Poisson's equation as before.
- ▶ This gives us a MOSFET, or Metal Oxide Semiconductor Field Effect Transistor:

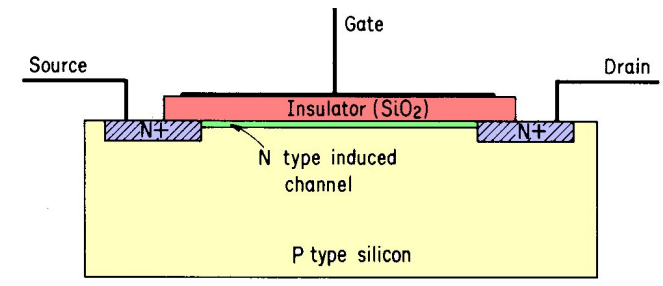

- ▶ Altering the gate voltage alters the number of electrons in the induced inversion layer: current can flow between the heavily n-type doped regions.
- ▶ Current-voltage characteristics of MOSFET (Mullard type BFW96)



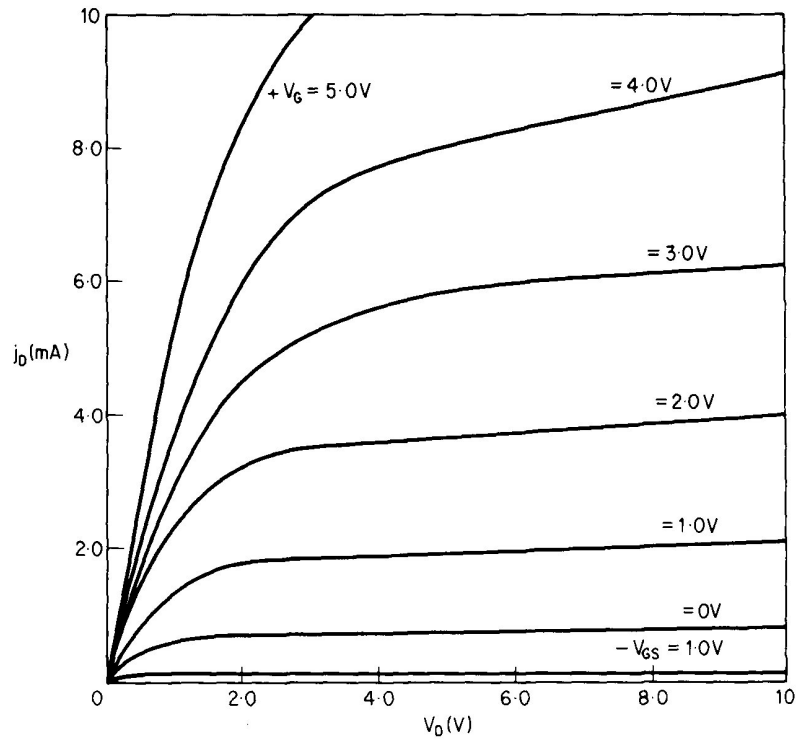

**9.11.3 Light-emitting diodes**

- ▶ These exploit the recombination that occurs when electrons in a forward-biased diode recombine with the holes.
- ▶ The trick is to alter the material to favour recombination which gives out energy as light rather than heat.
- ▶ Also alter the composition (e.g.  $\text{GaAs}_{1-x}\text{P}_x$ ) or add dopants such as zinc or oxygen. Can get blue from InGaN.

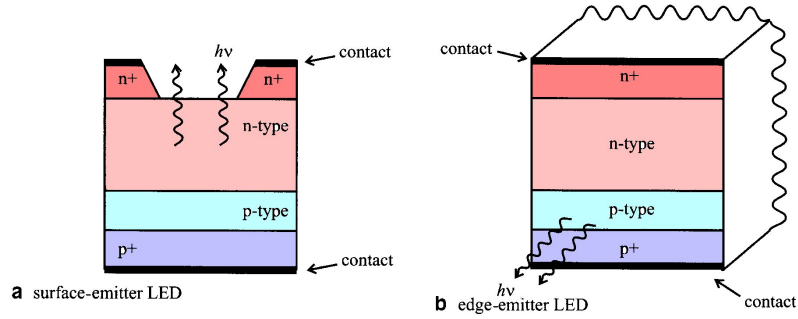

- ▶ The layer of electrons under a charged plate is an example of a *two-dimensional electron gas*.
- ▶ 2-D gases can also be formed in sandwich structures of materials with different band gaps.
- ▶ Narrow layers give free carrier motion in-plane, quantised states in the perpendicular direction – *quantum well devices*.

- ▶ Given a *population inversion* (large populations of electrons in the conduction band and holes in the valence band) we can get *lasing action*.
- ▶ This can be achieved with *degenerate doping* –  $E - \mu$  comparable with or less than  $k_B T$ .
- ▶ Also need to set structure up in resonance - multiple reflections in wave-guide structure.

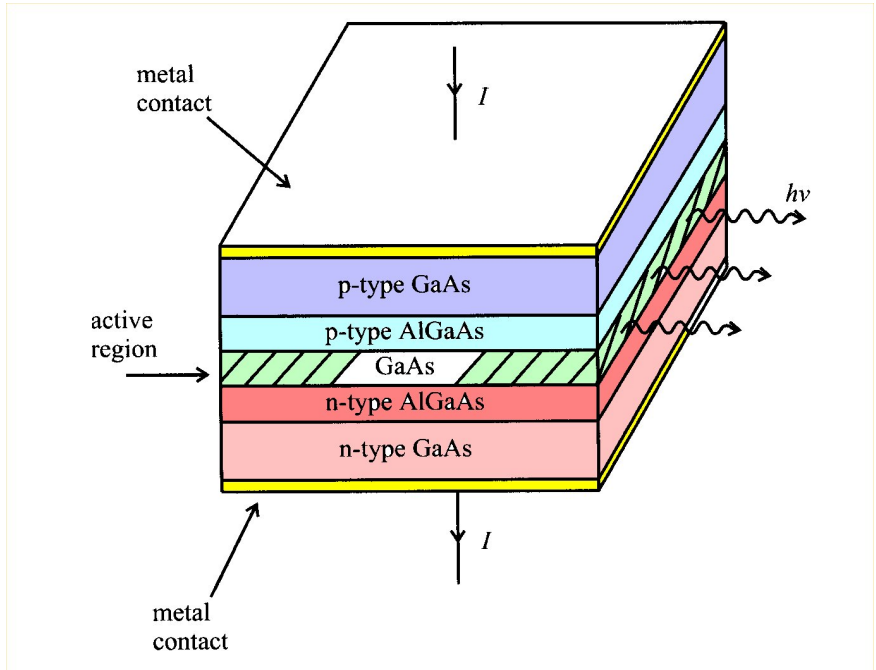

### 9.11.4 Solar cells

- ▶ In a solar cell, a photon is absorbed to create an electron-hole pair. These carriers move to produce a current proportional to the photon flux.

$$I = I_0 \left[ \exp \left( \frac{eV}{k_B T} \right) - 1 \right] - I_p,$$

where  $I_p$  is the photo-generated current.

- ▶ Characterised by the *quantum efficiency*,  $\eta$ , the number of electrons generated per photon. Typically about 0.7 for a Silicon solar cell.

# Chapter 10

## Magnetic Materials

### 10.1 Preliminaries

#### 10.1.1 Required Knowledge

- ▶ Magnetism
- ▶ Electron spin
- ▶ Atom
- ▶ Angular momentum (quantum)
- ▶ Statistical mechanics

#### 10.1.2 Reading

- ▶ Hook and Hall 7.1-7.3, 8.1-8.7

### 10.2 Introduction

- ▶ Magnet technology has made enormous advances in recent years – without the reductions in size that have come with these advances many modern devices would be impracticable.

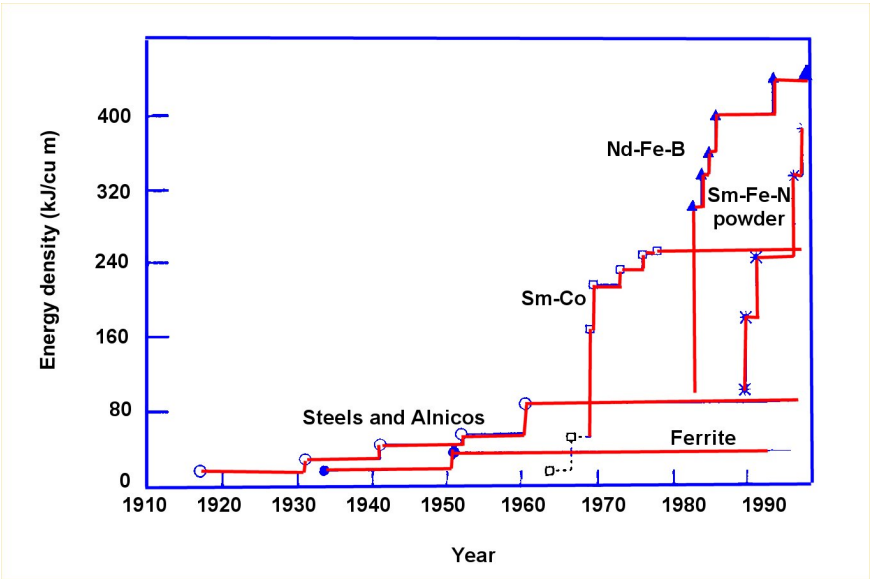
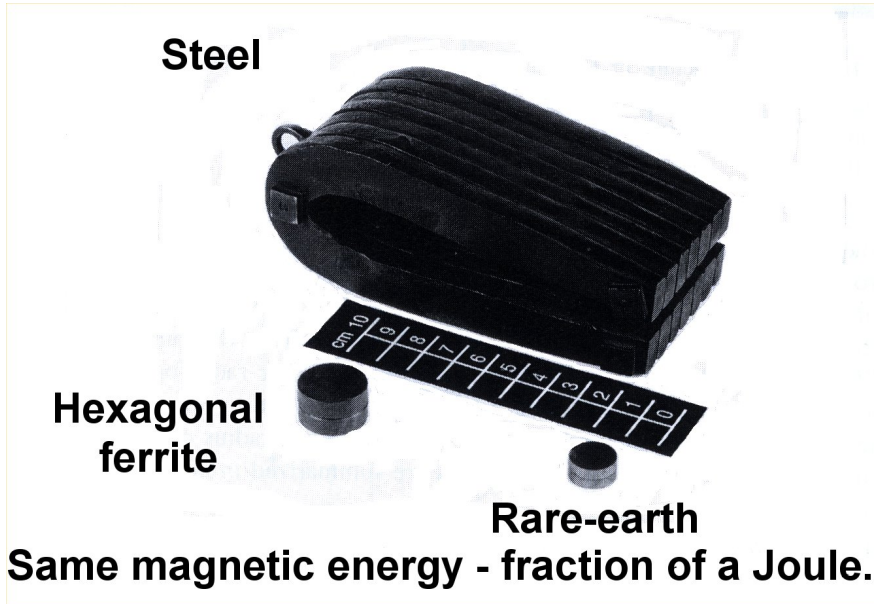

### 10.3 Magnetic properties - reminder

- ▶ There are two fields to consider:
  - ▷ The magnetic field  $\mathcal{H}$  which is generated by currents according to Ampère’s law.  $\mathcal{H}$  is measured in  $A\ m^{-1}$  (Oersteds in old units)
  - ▷ The magnetic induction, or magnetic flux density,  $\mathcal{B}$ , which gives the energy of a dipole in a field,  $E = -\mathbf{m} \cdot \mathcal{B}$  and the torque experienced by a dipole moment  $\mathbf{m}$  as  $\mathbf{G} = \mathbf{m} \times \mathcal{B}$ .  $\mathcal{B}$  is measured in  $Wb\ m^{-2}$  or T (Gauss in old units).
- ▶ In free space,  $\mathcal{B} = \mu_0 \mathcal{H}$ .

▶ The important quantity for many purposes is the energy density of the magnet.

► In a material

$$\begin{aligned} \mathcal{B} &= \mu_0(\mathcal{H} + \mathcal{M}) \\ &= \mu_0\mu_r\mathcal{H} \end{aligned}$$

where  $\mu_r$  is the relative permeability,  $\chi$  is the magnetic susceptibility, which is a dimensionless quantity.

► Note, though, that  $\chi$  is sometimes tabulated as the *molar susceptibility*

$$\chi_m = V_m\chi,$$

where  $V_m$  is the volume occupied by one mole, or as the *mass susceptibility*

$$\chi_g = \frac{\chi}{\rho},$$

where  $\rho$  is the density.

►  $\mathcal{M}$ , the magnetisation, is the dipole moment per unit volume.

$$\mathcal{M} = \chi\mathcal{H}.$$

► In general,  $\mu_r$  (and hence  $\chi$ ) will depend on position and will be tensors (so that  $\mathcal{B}$  is not necessarily parallel to  $\mathcal{H}$ ).

► Even worse, some materials are non-linear, so that  $\mu_r$  and  $\chi$  are field-dependent.

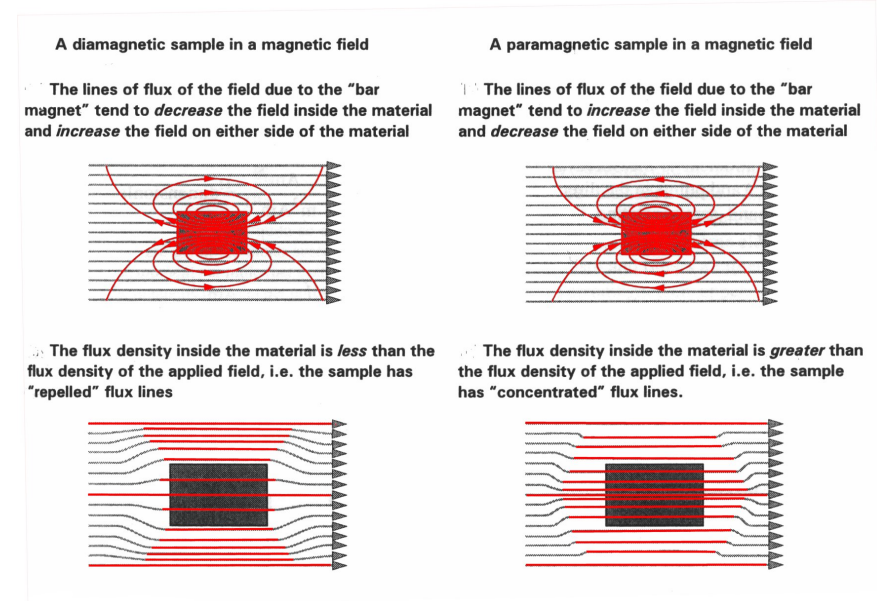

► The effects are *highly exaggerated* in these diagrams.

## 10.4 Measuring magnetic properties

### 10.4.1 Force method

► Uses energy of induced dipole

$$E = -\frac{1}{2}m\mathcal{B} = -\frac{1}{2}\mu_0\chi V\mathcal{H}^2,$$

so in an inhomogeneous field

$$F = -\frac{dE}{dx} = \frac{1}{2}\mu_0V\chi\frac{d\mathcal{H}^2}{dx} = \mu_0V\chi\mathcal{H}\frac{d\mathcal{H}}{dx}.$$

► Practically:

- ▷ set up large uniform  $\mathcal{H}$ ;
- ▷ superpose linear gradient with additional coils
- ▷ vary second field sinusoidally and use lock-in amplifier to measure varying force

► measure emf induced in coils A and B

► compare with emf in C and D from known magnetic moment

► hence measured sample magnetic moment

**10.4.2 Vibrating Sample magnetometer**

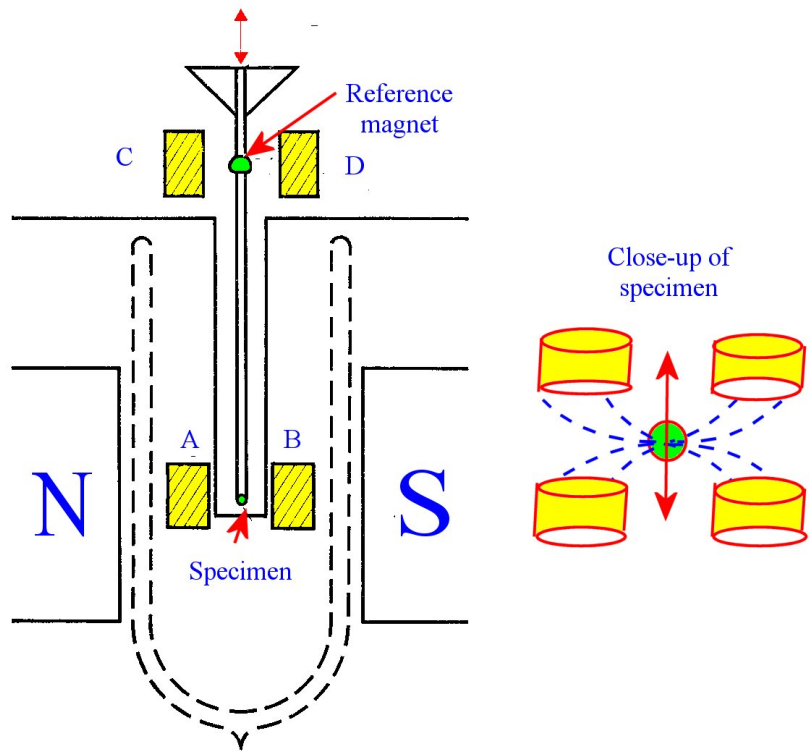

► oscillate sample up and down

**10.5 Experimental data**

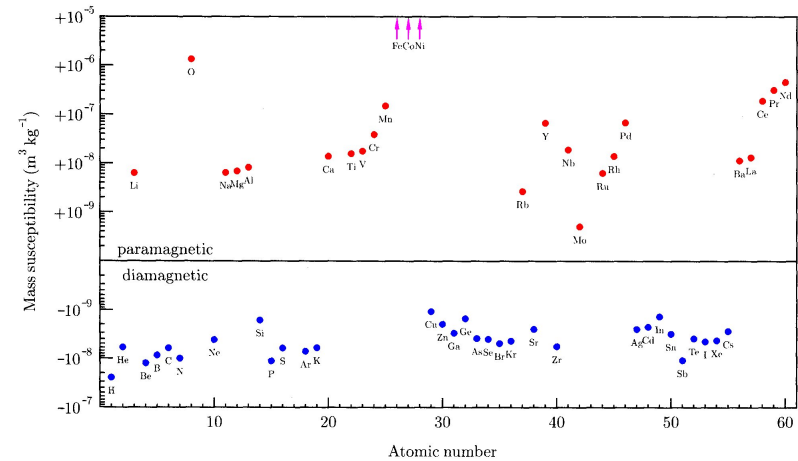

► In the first 60 elements in the periodic table, the majority have negative susceptibility – they are *diamagnetic*.

**10.6 Diamagnetism**

► Classically, we have Lenz's law, which states that the action of a magnetic field on the orbital motion of an electron causes a back-emf which opposes the magnetic field which causes it.

► Frankly, this is an unsatisfactory explanation, but we cannot do better until we have studied the inclusion of magnetic fields into quantum mechanics using magnetic vector potentials.

► Imagine an electron in an atom as a charge  $e$  moving clockwise in the  $x$ - $y$  plane in a circle of radius  $a$ , area  $A$ , with angular velocity  $\omega$ .

► This is equivalent to a current

$$I = \text{charge/time} = e\omega/(2\pi),$$

so there is a magnetic moment

$$\mu = IA = e\omega a^2/2.$$

► The electron is kept in this orbit by a central force

$$F = m_e\omega^2 a.$$

► Now if a flux density  $\mathcal{B}$  is applied in the  $z$  direction there will be a Lorentz force giving an additional force along a radius

$$\Delta F = ev\mathcal{B} = e\omega a\mathcal{B}$$

► If we assume the charge keeps moving in a circle of the same radius it will have a new angular velocity  $\omega'$ ,

$$m_e\omega'^2 a = F - \Delta F$$

so

$$m_e\omega'^2 a = m_e\omega^2 a - e\omega a\mathcal{B},$$

or

$$\omega'^2 - \omega^2 = -\frac{e\omega\mathcal{B}}{m_e}.$$

► If the change in frequency is small we have

$$\omega'^2 - \omega^2 \approx 2\omega\Delta\omega,$$

where  $\Delta\omega = \omega' - \omega$ . Thus

$$\Delta\omega = -\frac{e\mathcal{B}}{2m_e}.$$

where  $\frac{e\mathcal{B}}{2m_e}$  is called the *Larmor frequency*.

► Substituting back into

$$\mu = IA = e\omega a^2/2,$$

we find a change in magnetic moment

$$\Delta\mu = -\frac{e^2 a^2}{4m_e}\mathcal{B}.$$

► Recall that  $a$  was the radius of a ring of current perpendicular to the field: if we average over a spherical atom

$$a^2 = \langle x^2 \rangle + \langle y^2 \rangle = \frac{2}{3} [\langle x^2 \rangle + \langle y^2 \rangle + \langle z^2 \rangle] = \frac{2}{3} \langle r^2 \rangle,$$

so

$$\Delta\mu = \frac{e^2 \langle r^2 \rangle}{6m_e}\mathcal{B},$$

► If we have  $n$  atoms per volume, each with  $p$  electrons in the outer shells, the magnetisation will be

$$\mathcal{M} = np\Delta\mu,$$

and

$$\chi = \frac{\mathcal{M}}{\mathcal{H}} = \mu_0 \frac{\mathcal{M}}{\mathcal{B}} = -\frac{\mu_0 n p e^2 \langle r^2 \rangle}{6m_e}.$$

- ▶ Values of atomic radius are easily calculated: we can confirm the  $p\langle r^2 \rangle$  dependence.

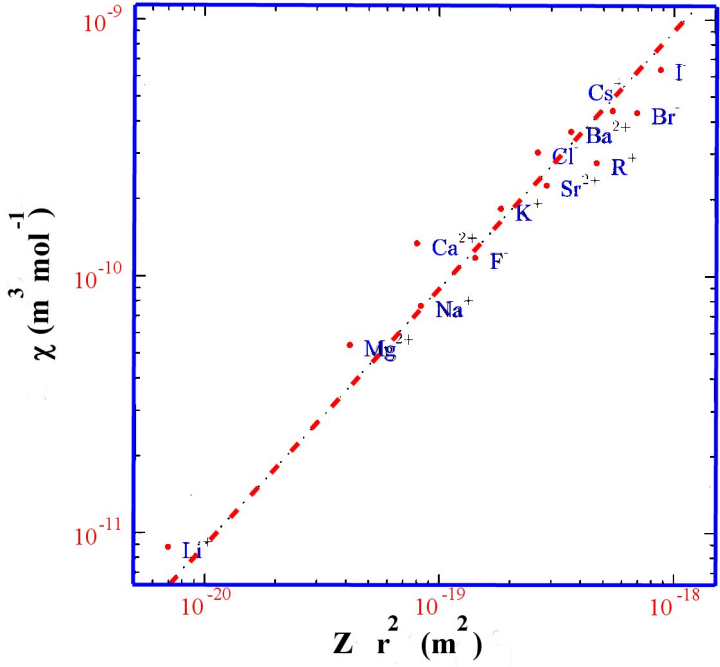

- ▶ *Diamagnetic susceptibility:*
  - ▷ Negative
  - ▷ Typically  $-10^{-6}$  to  $-10^{-5}$
  - ▷ Independent of temperature
  - ▷ Always present, even when there are no permanent dipole moments on the atoms.

## 10.7 Paramagnetism

- ▶ Paramagnetism occurs when the material contains permanent magnetic moments.
- ▶ If the magnetic moments do not interact with each other, they will be randomly arranged in the absence of a magnetic field.
- ▶ When a field is applied, there is a balance between the internal energy trying to arrange the moments parallel to the field and entropy trying to randomise them.
- ▶ The magnetic moments arise from electrons, but if we they are localised at atomic sites we can regard them as distinguishable, and use Boltzmann statistics.

### 10.7.1 Paramagnetism of spin- $\frac{1}{2}$ ions

- ▶ The spin is either up or down relative to the field, and so the magnetic moment is either  $+\mu_B$  or  $-\mu_B$ , where

$$\mu_B = \frac{e\hbar}{2m_e} = 9.274 \times 10^{-24} \text{ Am}^2.$$

- ▶ The corresponding energies in a flux density  $\mathcal{B}$  are  $-\mu_B\mathcal{B}$  and  $\mu_B\mathcal{B}$ , so the average magnetic moment per atom is

$$\begin{aligned} \langle \mu \rangle &= \frac{\mu_B e^{\mu_B \mathcal{B} / k_B T} - \mu_B e^{-\mu_B \mathcal{B} / k_B T}}{e^{\mu_B \mathcal{B} / k_B T} + e^{-\mu_B \mathcal{B} / k_B T}} \\ &= \mu_B \tanh \left( \frac{\mu_B \mathcal{B}}{k_B T} \right). \end{aligned}$$



- ▶ For small  $z$ ,  $\tanh z \approx z$ , so for small fields or high temperature

$$\langle \mu \rangle \approx \frac{\mu_B^2 \mathcal{B}}{k_B T}.$$

- ▶ If there are  $n$  atoms per volume, then,

$$\chi = \frac{n \mu_0 \mu_B^2}{k_B T}.$$

- ▶ Clearly, though, for low  $T$  or large  $\mathcal{B}$  the magnetic moment per atom saturates, as it must, as the largest magnetisation possible *saturation magnetisation* has all the spins aligned fully,

$$\mathcal{M}_s = n \mu_B.$$

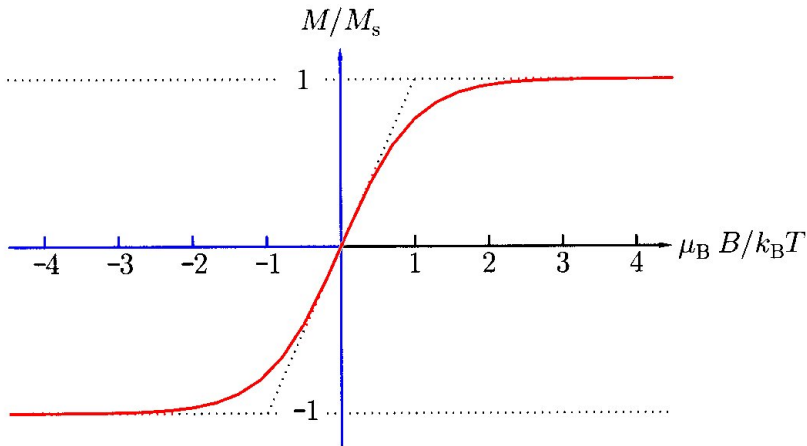

### 10.7.2 General $J$ ionic paramagnetism

- ▶ An atomic angular momentum  $J$ , made of spin  $S$  and orbital angular momentum quantum number  $L$ , will have a magnetic moment  $g_J \mu_B J$ , where  $g_J$  is the Landé  $g$ -factor

$$g_J = \frac{3}{2} + \frac{S(S+1) - L(L+1)}{2J(J+1)}.$$

- ▶ If we write  $x = g_J \mu_B \mathcal{B} / k_B T$ , the average atomic magnetic moment will be

$$\langle \mu \rangle = \frac{\sum_{m=-J}^J m g_J \mu_B e^{mx}}{\sum_{m=-J}^J e^{mx}}.$$

- ▶ If we assume that  $T$  is large and/or  $\mathcal{B}$  is small, we can expand the exponential, giving

$$\langle \mu \rangle \approx g_J \mu_B \frac{\sum_{m=-J}^J m(1+mx)}{\sum_{m=-J}^J (1+mx)}.$$

- ▶ We can evaluate this if we note that

$$\begin{aligned} \sum_{m=-J}^J 1 &= 2J + 1 \\ \sum_{m=-J}^J m &= 0 \\ \sum_{m=-J}^J m^2 &= \frac{1}{3} J(J+1)(2J+1) \end{aligned}$$

then

$$\begin{aligned}\langle \mu \rangle &\approx g_J \mu_B \frac{xJ(J+1)(2J+1)}{3(2J+1)} \\ &= \frac{g_J^2 \mu_B^2 \mathcal{B} J(J+1)}{3k_B T},\end{aligned}$$

► This leads to a susceptibility

$$\chi = \frac{\mu_0 n g_J^2 \mu_B^2 J(J+1)}{3k_B T}.$$

► This is *Curie's Law*, often written

$$\chi = \frac{C}{T}.$$

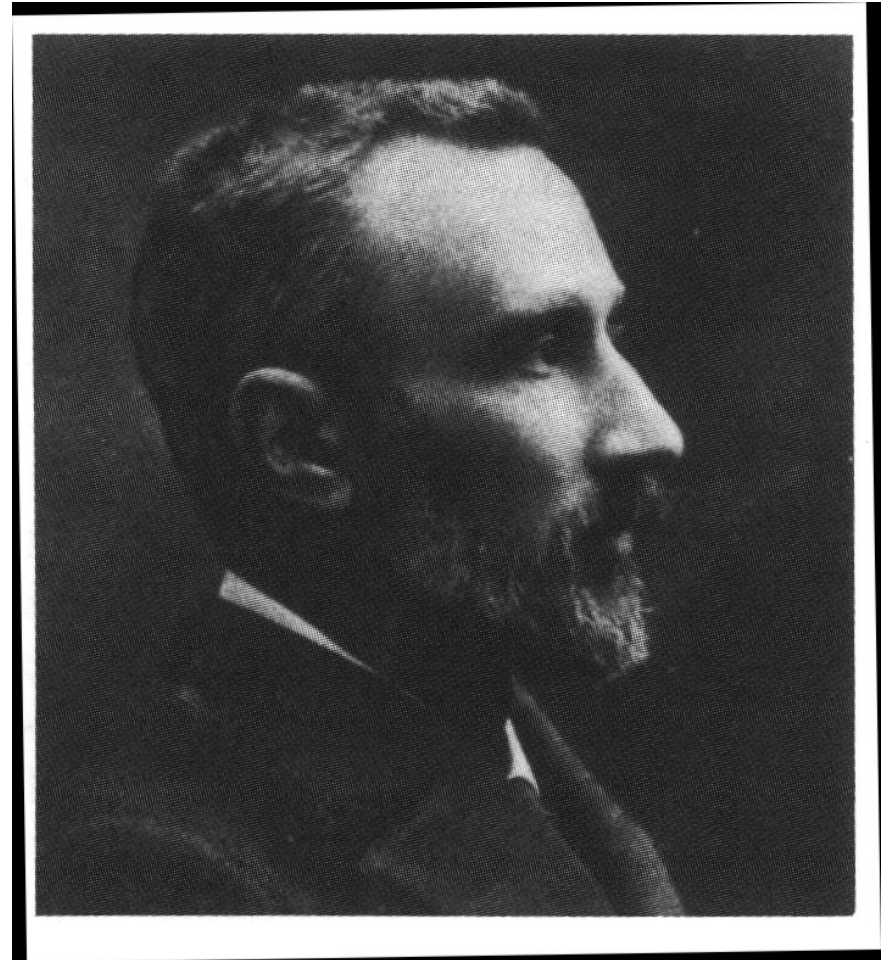

Pierre Curie

► Chromium potassium alum.

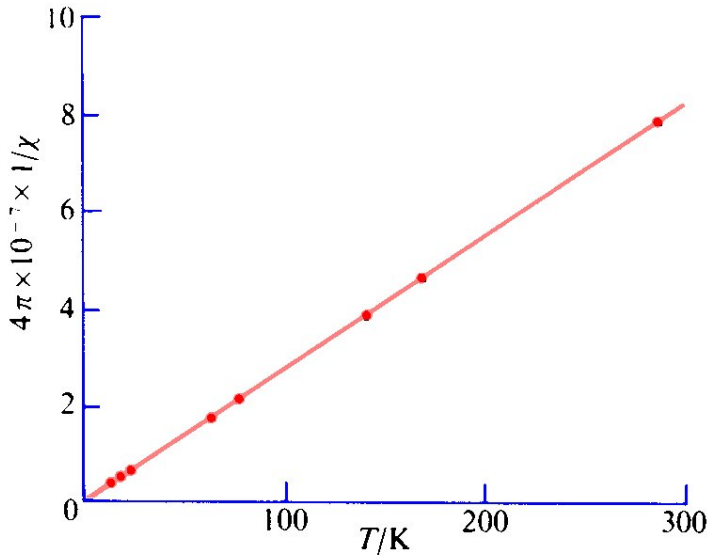

- ▶  $1/\chi$  is proportional to  $T$ , confirming Curie's law.
- ▶ Of course, eventually  $\mathcal{M}$  must saturate, as for the spin-1/2 system.
- ▶ The larger  $J$  the slower the saturation.
- ▶ A full treatment results in the Brillouin function,  $B_J(g_J\mu_B J\mathcal{B}/k_B T)$  giving the variation of  $\mathcal{M}/\mathcal{M}_s$ .

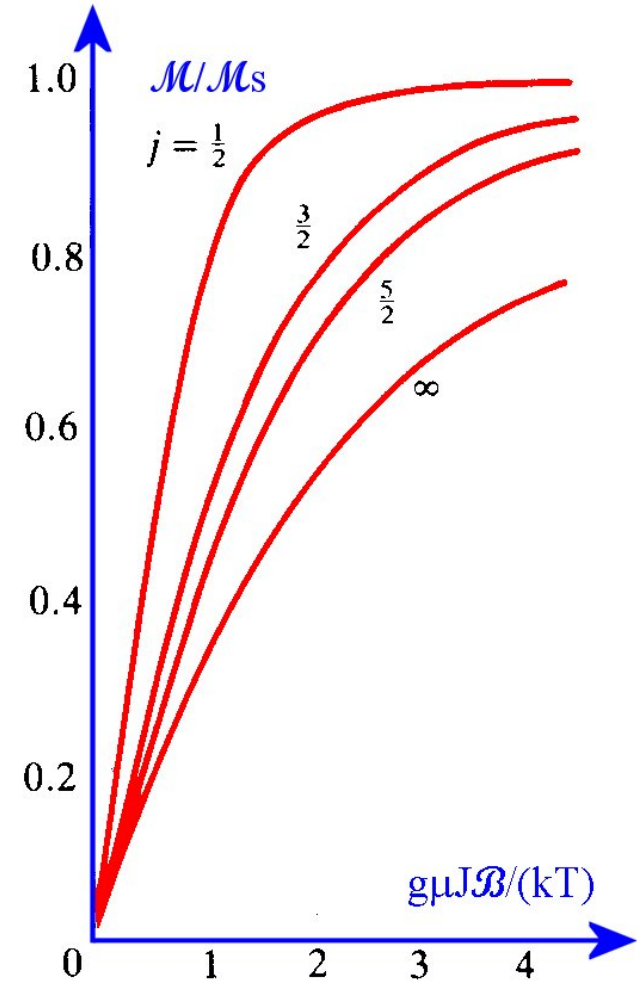

- ▶ Experimental results confirm this.

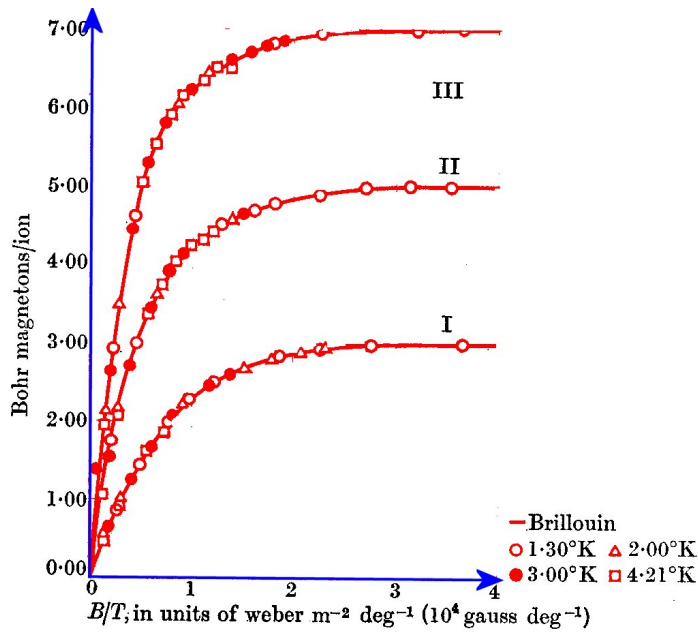

Plot of average magnetic moment per ion  $m$  against  $B/T$  for (I) potassium chromium alum ( $J = S = \frac{3}{2}$ ), (II) iron ammonium alum ( $J = S = \frac{5}{2}$ ), and (III) gadolinium sulphate octahydrate ( $J = S = \frac{7}{2}$ ).

► *Ionic paramagnetic susceptibility:*

- ▷ Positive
- ▷ Typically  $10^{-5}$  to  $10^{-3}$
- ▷ Temperature-dependent
- ▷ Arises from permanent dipole moments on the atoms
- ▷ Saturates for large  $B$  or low  $T$

10.7.3 States of ions in solids

► The ions which concern us here are those with part-filled shells, giving a net angular momentum.

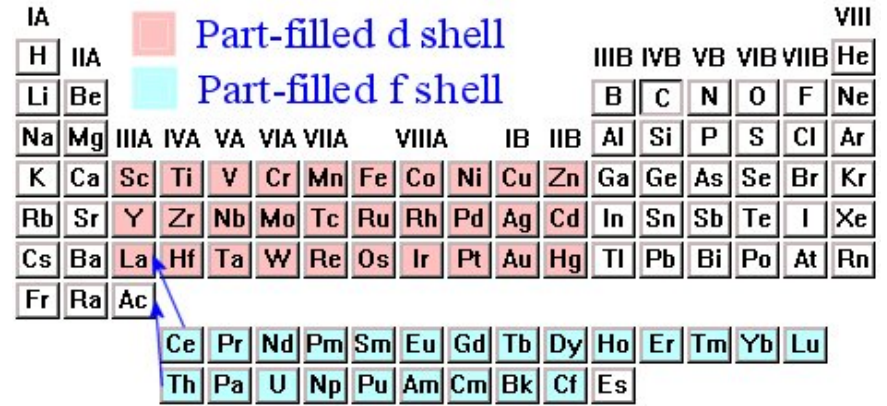

- Best studied are the first and second transition series, (Ti to Cu and Zr to Hg) and the rare earths (La to Lu).
- From atomic physics we know that a free atom or ion is characterised by quantum numbers  $L$ ,  $S$  and  $J$ , and for a given  $L$  and  $S$  may take up  $J$  values between  $|L - S|$  and  $L + S$ .
- Hund's rules tell us that the ground state is that for which
  - ▷  $S$  is as large as possible
  - ▷  $L$  is as large as possible for that  $S$
  - ▷  $J = \begin{cases} L - S & \text{if the shell is less than half full} \\ L + S & \text{if the shell is more than half full} \end{cases}$
- These represent the effects of exchange, correlation, and spin-orbit coupling respectively.

- We can deduce the magnetic moment per atom  $p\mu_B$  from the susceptibility, and compare with what Hund's rules tell us.

Ion	State	Term	$g\sqrt{J(J+1)}$	Experimental $p$
Ce <sup>3+</sup>	4f <sup>1</sup> 5s <sup>2</sup> p <sup>6</sup>	<sup>2</sup> F <sub>5/2</sub>	2.54	2.4
Pr <sup>3+</sup>	4f <sup>2</sup> 5s <sup>2</sup> p <sup>6</sup>	<sup>3</sup> H <sub>4</sub>	3.58	3.5
Nd <sup>3+</sup>	4f <sup>3</sup> 5s <sup>2</sup> p <sup>6</sup>	<sup>4</sup> I <sub>9/2</sub>	3.62	3.5
Pm <sup>3+</sup>	4f <sup>4</sup> 5s <sup>2</sup> p <sup>6</sup>	<sup>5</sup> I <sub>4</sub>	2.68	-
Sm <sup>3+</sup>	4f <sup>5</sup> 5s <sup>2</sup> p <sup>6</sup>	<sup>6</sup> H <sub>5/2</sub>	0.84	1.5
Eu <sup>3+</sup>	4f <sup>6</sup> 5s <sup>2</sup> p <sup>6</sup>	<sup>7</sup> F <sub>0</sub>	0.00	3.4
Gd <sup>3+</sup>	4f <sup>7</sup> 5s <sup>2</sup> p <sup>6</sup>	<sup>8</sup> S <sub>7/2</sub>	7.94	8.0
Tb <sup>3+</sup>	4f <sup>8</sup> 5s <sup>2</sup> p <sup>6</sup>	<sup>7</sup> F <sub>6</sub>	9.72	9.5
Dy <sup>3+</sup>	4f <sup>9</sup> 5s <sup>2</sup> p <sup>6</sup>	<sup>6</sup> H <sub>15/2</sub>	10.63	10.6
Ho <sup>3+</sup>	4f <sup>10</sup> 5s <sup>2</sup> p <sup>6</sup>	<sup>5</sup> I <sub>8</sub>	10.60	10.4
Er <sup>3+</sup>	4f <sup>11</sup> 5s <sup>2</sup> p <sup>6</sup>	<sup>4</sup> I <sub>15/2</sub>	9.59	9.5
Tm <sup>3+</sup>	4f <sup>12</sup> 5s <sup>2</sup> p <sup>6</sup>	<sup>3</sup> H <sub>6</sub>	7.57	7.3
Yb <sup>3+</sup>	4f <sup>13</sup> 5s <sup>2</sup> p <sup>6</sup>	<sup>2</sup> F <sub>7/2</sub>	4.54	4.5

- All look fine except for Sm and Eu, where higher  $J$  levels are very close to the ground state which means they are partly occupied above 0 K.

- Now look at the first transition series.

Ion	State	Term	$g\sqrt{J(J+1)}$	Experimental $p$
Ti <sup>3+</sup> , V <sup>4+</sup>	3d <sup>1</sup>	<sup>2</sup> D <sub>3/2</sub>	1.55	1.8
V <sup>3+</sup>	3d <sup>2</sup>	<sup>3</sup> F <sub>2</sub>	1.63	2.8
Cr <sup>3+</sup> , V <sup>2+</sup>	3d <sup>3</sup>	<sup>4</sup> F <sub>3/2</sub>	0.77	3.8
Mn <sup>3+</sup> , Cr <sup>2+</sup>	3d <sup>5</sup>	<sup>5</sup> D <sub>0</sub>	0.00	4.9
Fe <sup>3+</sup> , Mn <sup>2+</sup>	3d <sup>5</sup>	<sup>6</sup> S <sub>5/2</sub>	5.92	5.9
Fe <sup>2+</sup>	3d <sup>6</sup>	<sup>5</sup> D <sub>4</sub>	6.70	5.4
Co <sup>2+</sup>	3d <sup>7</sup>	<sup>4</sup> F <sub>9/2</sub>	6.63	4.8
Ni <sup>2+</sup>	3d <sup>8</sup>	<sup>3</sup> F <sub>4</sub>	5.59	3.2
Cu <sup>2+</sup>	3d <sup>9</sup>	<sup>2</sup> D <sub>5/2</sub>	3.55	1.9

- The agreement is very poor.
- The problem is *crystal field splitting*. Look at the electronic  $d$  states in a cubic crystal.

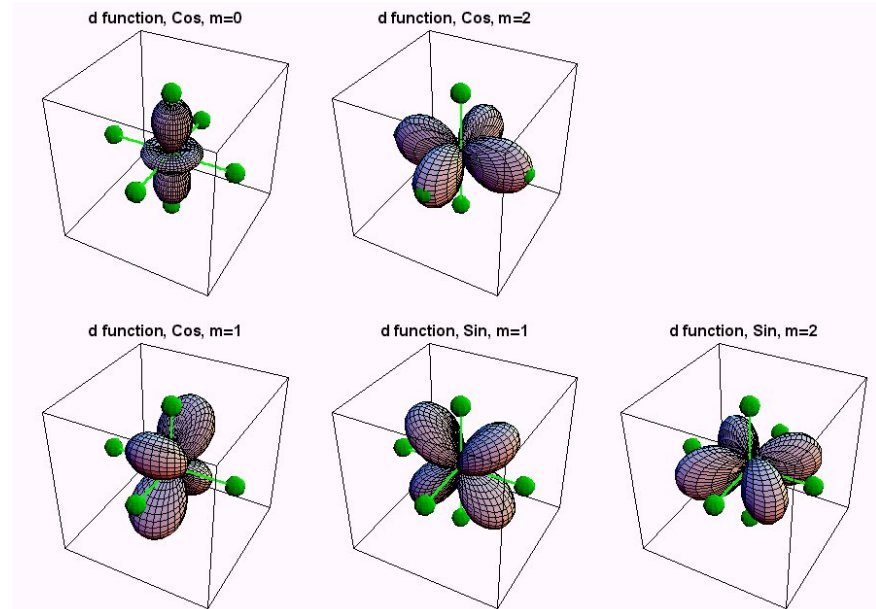

- ▶ Two states point directly towards neighbouring ions, three states point between neighbours.
- ▶ These states have different electrostatic energies.
- ▶ So the  $d$  states are ‘locked’ to the crystal, and no longer behave like an  $l = 2$  state with  $2l + 1$  *degenerate*  $m$  values.
- ▶ This is called *quenching* of the orbital angular momentum.
- ▶ In the first transition series, the magnetic moments arise almost entirely from spin.

Ion	State	Term	$g\sqrt{S(S + 1)}$	Experimental $p$
Ti <sup>3+</sup> , V <sup>4+</sup>	3d <sup>1</sup>	<sup>2</sup> D <sub>3/2</sub>	1.73	1.8
V <sup>3+</sup>	3d <sup>2</sup>	<sup>3</sup> F <sub>2</sub>	2.83	2.8
Cr <sup>3+</sup> , V <sup>2+</sup>	3d <sup>3</sup>	<sup>4</sup> F <sub>3/2</sub>	3.87	3.8
Mn <sup>3+</sup> , Cr <sup>2+</sup>	3d <sup>5</sup>	<sup>5</sup> D <sub>0</sub>	4.90	4.9
Fe <sup>3+</sup> , Mn <sup>2+</sup>	3d <sup>5</sup>	<sup>6</sup> S <sub>5/2</sub>	5.92	5.9
Fe <sup>2+</sup>	3d <sup>6</sup>	<sup>5</sup> D <sub>4</sub>	4.90	5.4
Co <sup>2+</sup>	3d <sup>7</sup>	<sup>4</sup> F <sub>9/2</sub>	3.87	4.8
Ni <sup>2+</sup>	3d <sup>8</sup>	<sup>3</sup> F <sub>4</sub>	2.83	3.2
Cu <sup>2+</sup>	3d <sup>9</sup>	<sup>2</sup> D <sub>5/2</sub>	1.73	1.9

- ▶ Magnetism in transition metal ions arises almost entirely from *spin*.
- ▶ The rare earths behave differently because the 4f electrons are in smaller orbits than the 3d ones, and because spin-orbit coupling is larger in the 4f ions.

## 10.8 Interacting magnetic moments

- ▶ So far we have no explanation for the existence of ferromagnetism.

- ▶ By measuring the magnetic moment of a specimen of a ferromagnet, we can see that the magnetisation must be near saturation.

- ▶ A quick look at the Brillouin function

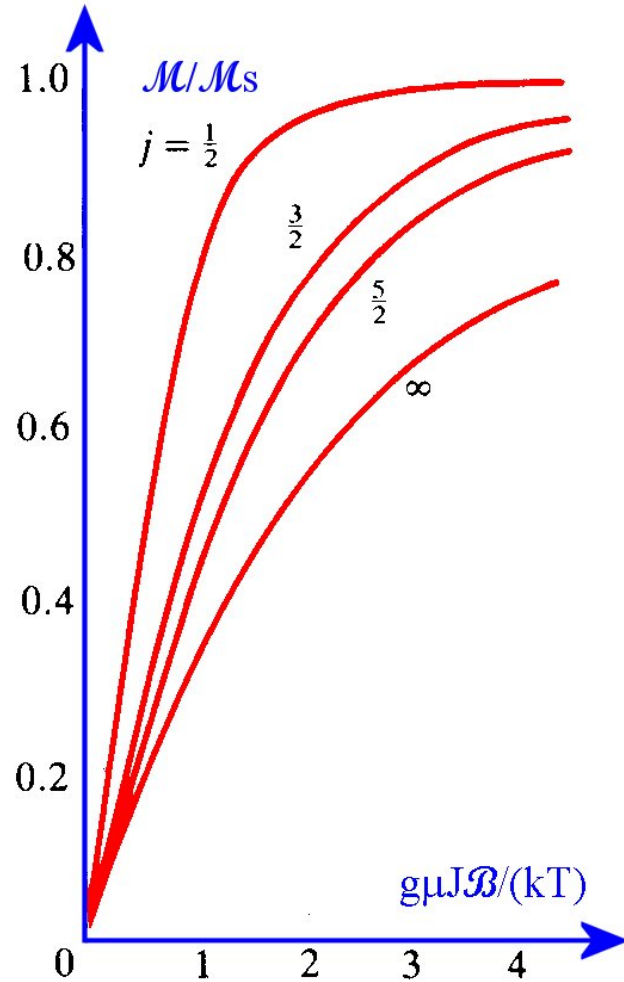

► shows that at room temperature this needs

$$\frac{g_J \mu_B \mathcal{B}}{k_B T} \approx 1,$$

► At room temperature, taking  $g_J \approx 2$ ,  $\mathcal{B} \approx 200$  T.

### 10.8.1 Direct magnetic interaction

- Where can such a large field come from?
- Can it be direct interactions between spins a lattice spacing (say 0.25 nm) apart?

► The field from one Bohr magneton at a distance  $r$  is of order

$$\mathcal{B} = \frac{\mu_0 \mu_B}{4\pi r^3} \approx 0.06 \text{ T},$$

► So direct magnetic interactions are irrelevant (though they are significant in, for example, limiting the temperatures that can be reached by adiabatic demagnetisation).

### 10.8.2 Exchange interaction

- The interaction is *quantum mechanical*, a form of *exchange interaction*.
- Recall Hund's rules: there exchange favoured parallel spins.
- We write the Hamiltonian for the interaction between two spins on different sites  $i$  and  $j$  as

$$\mathcal{H}_{ij}^{\text{spin}} = -2J_{ij} \mathbf{S}_i \cdot \mathbf{S}_j,$$

where  $J_{ij}$ , the exchange integral, depends on the overlap between wavefunctions on different sites.

- ▶ Positive  $J$  favours parallel spins, negative  $J$  favours antiparallel spins.
- ▶ For the whole crystal,

$$\mathcal{H}^{\text{spin}} = - \sum_{i,j} J_{ij} \mathbf{S}_i \cdot \mathbf{S}_j,$$

or

$$\mathcal{H}^{\text{spin}} = -2 \sum_{i < j} J_{ij} \mathbf{S}_i \cdot \mathbf{S}_j.$$

### 10.8.3 Effective field model

- ▶ For a particular spin,  $i$ , we can write the interaction term as

$$\begin{aligned} \mathcal{H}_i^{\text{spin}} &= -2 \sum_{j \neq i} J_{ij} \mathbf{S}_i \cdot \mathbf{S}_j \\ &= - \left( 2 \sum_{j \neq i} J_{ij} \mathbf{S}_j \right) \cdot \mathbf{S}_i. \end{aligned}$$

- ▶ Now note two points:

1. The form of the interaction,  $-(\dots) \cdot \mathbf{S}$ , looks like the interaction of a spin with a magnetic field. Write

$$\begin{aligned} \mathcal{H}_i^{\text{spin}} &= - \left( 2 \sum_{j \neq i} (J_{ij} / (g_S \mu_B)) \mathbf{S}_j \right) \cdot (g_S \mu_B \mathbf{S}_i) \\ &= -\mathcal{B}_{\text{eff}} \cdot \mathbf{m}_i, \end{aligned}$$

where  $m_i$  is the magnetic moment on atom  $i$ .

2. The summation suggests that we should be able to do some averaging over the spins.

### 10.8.4 The mean field approximation

- ▶ Assume that each spin interacts only with its  $z$  nearest neighbours. Then

$$\begin{aligned} \mathcal{B}_{\text{eff}} &= \left( 2 \sum_{j=1}^z \frac{J}{g_S \mu_B} \mathbf{S}_j \right) \\ &= 2 \sum_{j=1}^z \frac{J}{g_S \mu_B} \frac{\mathbf{m}_j}{g_S \mu_B} \\ &= 2 \frac{J}{g_S \mu_B} \frac{z \langle \mathbf{m}_j \rangle}{g_S \mu_B}. \end{aligned}$$

- ▶ Now identify the average magnetic moment per volume with the magnetisation:

▶

$$n \langle \mathbf{m}_j \rangle = \mathcal{M},$$

for  $n$  spins per unit volume, giving

$$\begin{aligned} \mathcal{B}_{\text{eff}} &= 2 \frac{J}{g_S \mu_B} \frac{z \mathcal{M}}{n g_S \mu_B} \\ &= \frac{2zJ}{n g_S^2 \mu_B^2} \mathcal{M}. \end{aligned}$$



- ▶ This gives the *Weiss internal field model* or *molecular field model* (not originally derived in this way)
- ▶ The energy of a dipole in the ferromagnet is equivalent to an effective field

$$B_{\text{eff}} = \lambda \mathcal{M}.$$

- ▶ Note that this is *NOT* a real magnetic field. The origin is quantum-mechanical exchange, not magnetism, and as the interaction that underlies exchange is the Coulomb interaction it can be much stronger.

### 10.8.5 Mean field theory of ferromagnetism

- ▶ Armed with the mean field picture, and a picture of the way  $\mathcal{M}$  depends on  $\mathcal{B}$  through the Brillouin function, we have

$$\frac{\mathcal{M}}{\mathcal{M}_s} = B_J \left( \frac{g_J \mu_B J (\mathcal{B} + \lambda \mathcal{M})}{k_B T} \right). \tag{10.1}$$

- ▶ Assume for the moment that  $\mathcal{B} = 0$ . Then we can plot the two sides of equation as functions of  $\mathcal{M}/T$ :

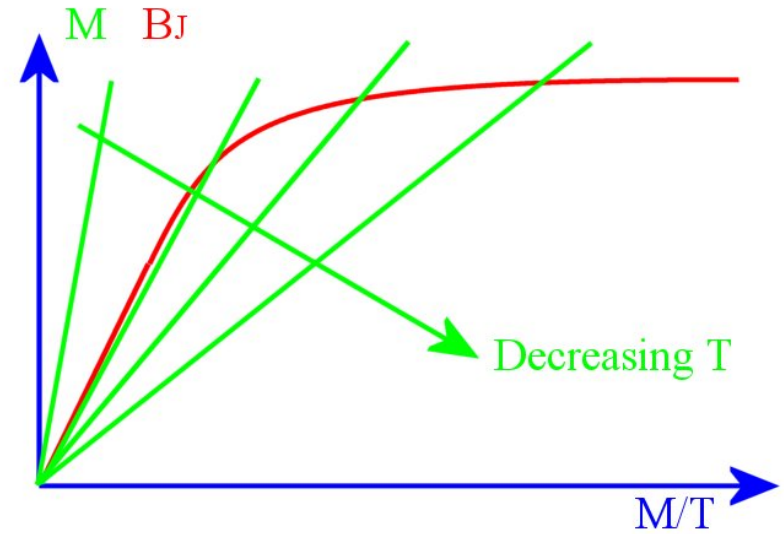

- ▶ As  $T$  decreases the straight line  $\mathcal{M}$  gets less steep. Thus for lower  $T$  there is a solution to

$$\frac{\mathcal{M}}{\mathcal{M}_s} = B_J \left( \frac{g_J \mu_B J \lambda \mathcal{M}}{k_B T} \right)$$

for finite  $\mathcal{M}$ .

- ▶ Furthermore the shape of  $B_J$ , a convex curve, shows that there is a critical temperature  $T_C$  above which the  $\mathcal{M}$  line is too steep to intersect the  $B_J$  curve except at  $\mathcal{M} = 0$ .

- ▶ For small values of  $\mathcal{M}/T$  we can use Curie's law,

$$\chi = \frac{\mu_0 n g_J^2 \mu_B^2 J(J+1)}{3k_B T}$$

and

$$\chi = \frac{\mathcal{M}}{\mathcal{H}} = \frac{n g_J J \mu_B B_J}{\mathcal{H}}$$

to deduce

$$B_J \left( \frac{g_J \mu_B J \mathcal{B}}{k_B T} \right) \approx \frac{g_J \mu_B (J + 1) \mathcal{B}}{3 k_B T}.$$

► In terms of  $x = \mathcal{M}/T$ , the straight line is

$$\frac{\mathcal{M}}{\mathcal{M}_s} = \frac{T x}{\mathcal{M}_s}$$

and the approximation to the Brillouin function is (putting  $\lambda \mathcal{M}$  for  $\mathcal{B}$ )

$$B_J \approx \lambda \mathcal{M} \frac{g_J \mu_B (J + 1)}{3 k_B T} = \lambda \frac{g_J \mu_B (J + 1)}{3 k_B} x.$$

► Equating the gradients with respect to  $x$ ,

$$\frac{T_C}{\mathcal{M}_s} = \lambda \frac{g_J \mu_B (J + 1)}{3 k_B},$$

or

$$\begin{aligned} T_C &= \lambda \frac{g_J \mu_B (J + 1) \mathcal{M}_s}{3 k_B} \\ &= \frac{\lambda n g_J^2 \mu_B^2 J (J + 1)}{3 k_B}. \end{aligned}$$

► The critical temperature  $T_C$  is the *Curie temperature* – often denoted by  $\theta$ .

► Some ferromagnetic materials

Material	$T_C$ (K)	$\mu_B$ per formula unit
Fe	1043	2.22
Co	1394	1.715
Ni	631	0.605
Gd	289	7.5
MnSb	587	3.5
EuO	70	6.9
EuS	16.6	6.9

► Below  $T_C$  the spontaneous magnetisation varies with temperature.

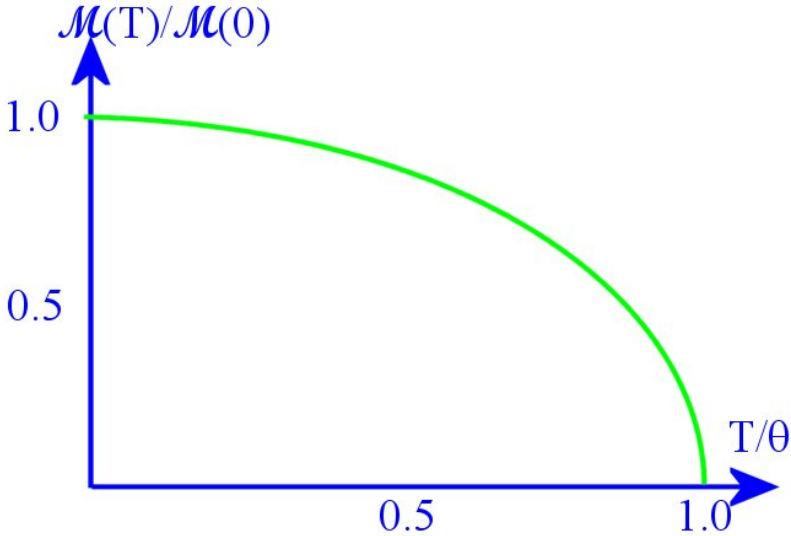

### 10.8.6 Paramagnetic regime

- ▶ Above the Curie temperature, if we apply a magnetic field, we have

$$B_J = \frac{\mathcal{M}}{\mathcal{M}_s} \approx (\mathcal{B} + \lambda\mathcal{M}) \frac{g_J\mu_B(J+1)}{3k_B T}$$

- ▶ This can be rearranged to give

$$\mathcal{M} = \frac{\frac{\mathcal{M}_s \mathcal{B} g_J (J+1) \mu_B}{3k_B}}{T - \frac{\lambda \mathcal{M}_s g_J (J+1) \mu_B}{3k_B}},$$

- ▶ With  $\mathcal{M}_s = n g_J J \mu_B$

$$\begin{aligned} \mathcal{M} &= \frac{\frac{n \mathcal{B} g_J^2 J (J+1) \mu_B^2}{3k_B}}{T - \frac{\lambda n g_J^2 J (J+1) \mu_B^2}{3k_B}} \\ &= \frac{\frac{n \mathcal{B} g_J^2 J (J+1) \mu_B^2}{3k_B}}{T - T_C} \end{aligned}$$

- ▶ This gives a susceptibility

$$\chi \propto \frac{1}{T - T_C},$$

which is the *Curie-Weiss law*.

- ▶ The Curie-Weiss law works quite well at high  $T$

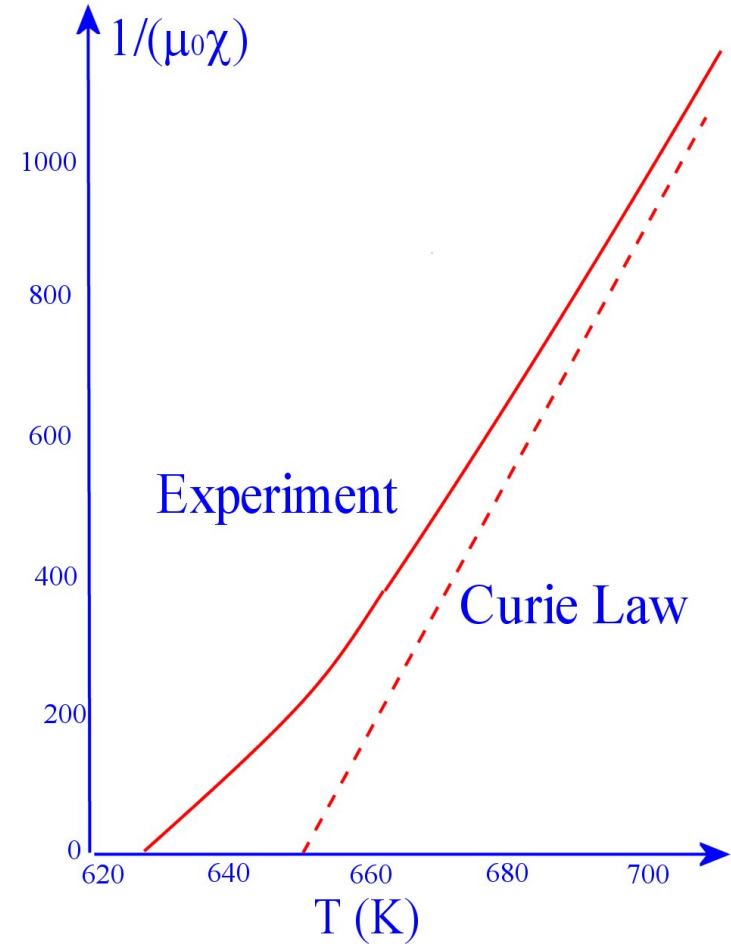

- ▶ It breaks down near the Curie temperature  $T_C$  or  $\theta$ , where the mean field approximation fails.

### 10.8.7 Effect of magnetic field on ferromagnet

► At low temperatures, the magnetisation is nearly saturated, so a  $\mathcal{B}$  field has little effect:

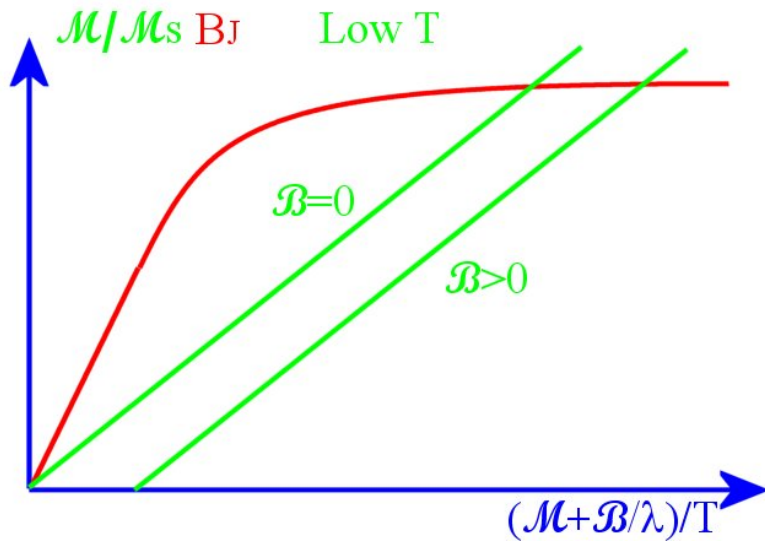

► As we increase the temperature, we reach a regime where the field has a large effect on the magnetisation:

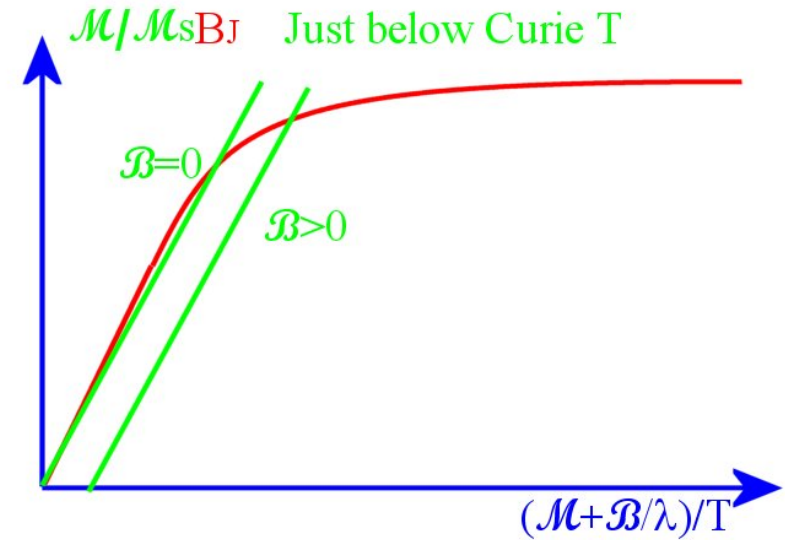

► At high temperature we are in the Curie-Weiss regime than we described above:

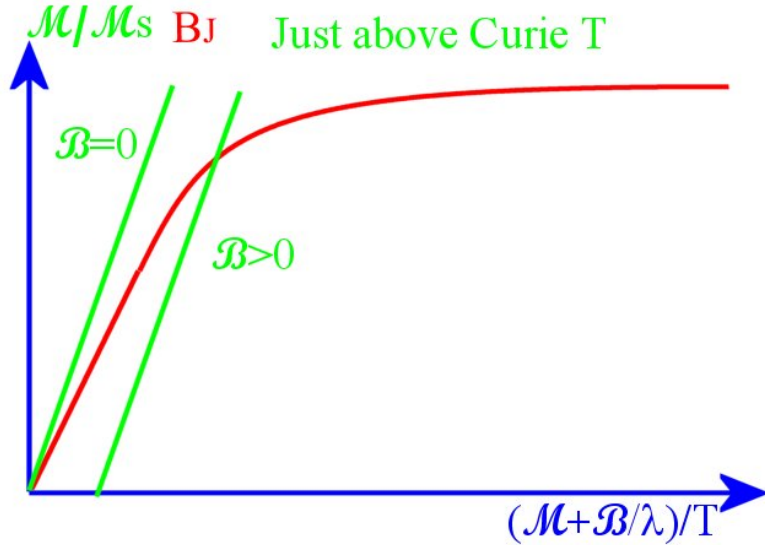

► Overall, then, the effect of a field is:

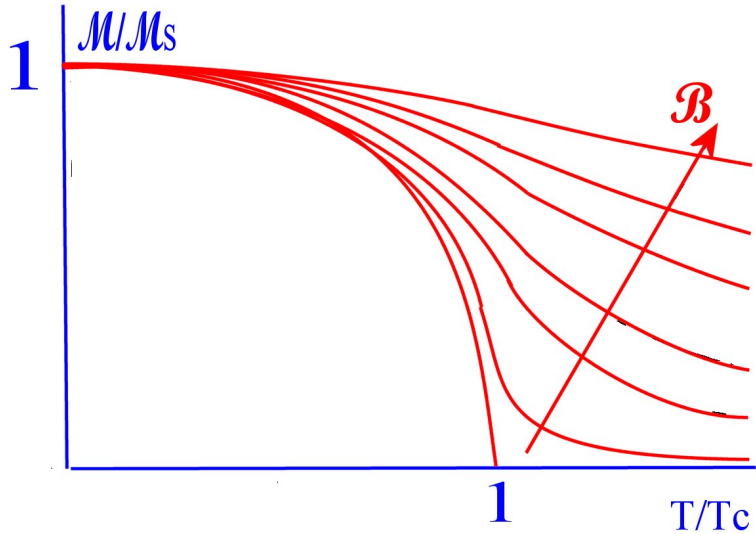

**10.8.8 Anisotropy in magnetic systems**

- The quenching of orbital angular momentum in a crystal is one effect of the crystal field (the electrostatic potential variation in the solid).
- But as spin-orbit coupling links the spins to the spatial variation of the wavefunctions, the spins tend to align more readily along certain directions in the crystal: the *easy directions of magnetisation*.

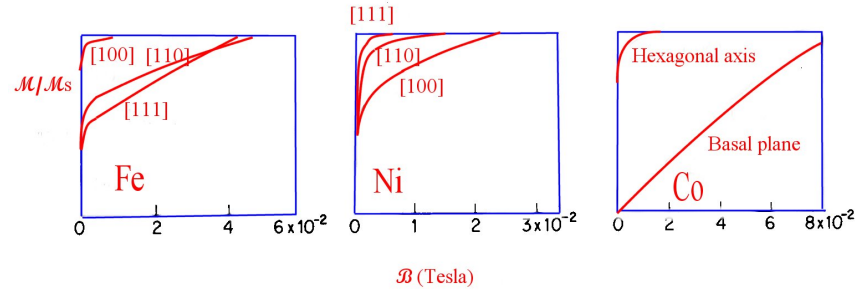

**10.9 Magnetic domains**

- In general, a lump of ferromagnetic material will not have a nett magnetic moment, despite the fact that internally the spins tend to align parallel to one another.

**10.9.1 Magnetic field energy**

- The total energy of a ferromagnetic material has two components:

- 1. The internal energy (including the exchange energy) tending to align spins
- 2. The energy  $\int \mathcal{B} \cdot \mathcal{H} dV$  in the field outside it.

► The external field energy can be decreased by dividing the material into *domains*.

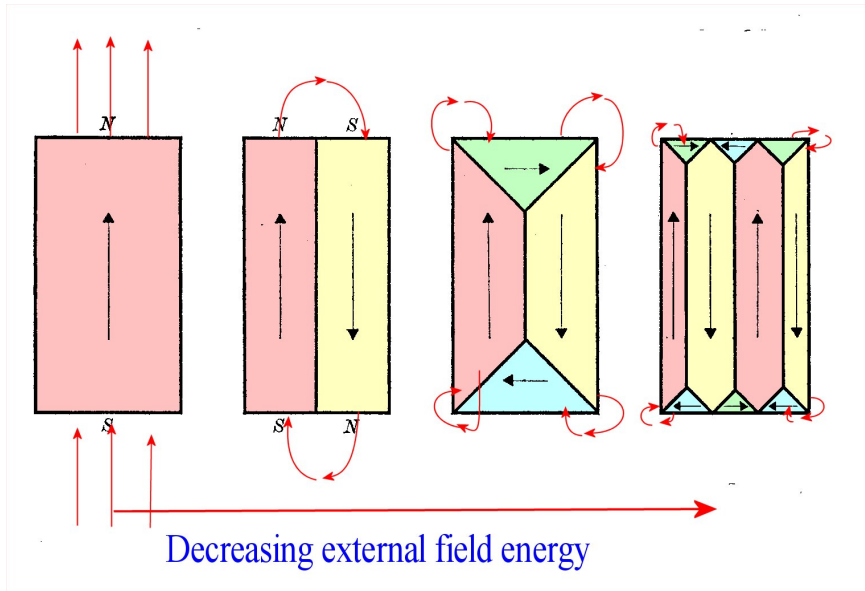

► The internal energy is increased because not all the spins are now aligned parallel to one another.

**10.9.2 Domain walls**

► What is the structure of the region between two domains (called a *domain wall* or a *Bloch wall*)?

► The spins do not suddenly flip: a gradual change of orientation costs less energy because if successive spins are misaligned by  $\delta\theta$  the change in energy is only

$$\delta E = 2JS^2(1 - \cos(\delta\theta)),$$

where  $J$  is the exchange integral.

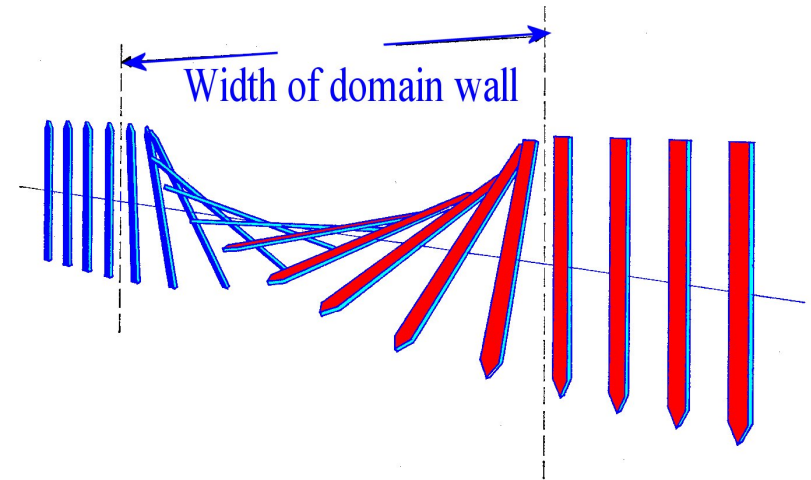

► For small  $\delta\theta$ , expanding the cosine,

$$\delta E = 2JS^2(1 - \cos(\delta\theta)) \approx 2JS^2 \frac{1}{2}(\delta\theta)^2$$

► If we extend the change in spin direction (total angle change of  $\pi$ ) over  $N$  spins,  $\delta\theta = \pi/N$ , and there are  $N$  such changes of energy  $\delta E$ , the total energy change is

$$\Delta E = JS^2 \frac{\pi^2}{N}.$$

- ▶ This favours wide walls, but then there are more spins aligned away from easy directions, providing a balance. Bloch walls are typically about 100 atoms thick.
- ▶ In very small particles, the reduction in field energy is too small to balance the domain wall energy. Thus small particles stay as single domains and form *superparamagnets*.
- ▶ Small magnetic particles are found in some bacteria (*magnetotactic bacteria*) which use the angle of dip of the Earth's magnetic field to direct them to food.

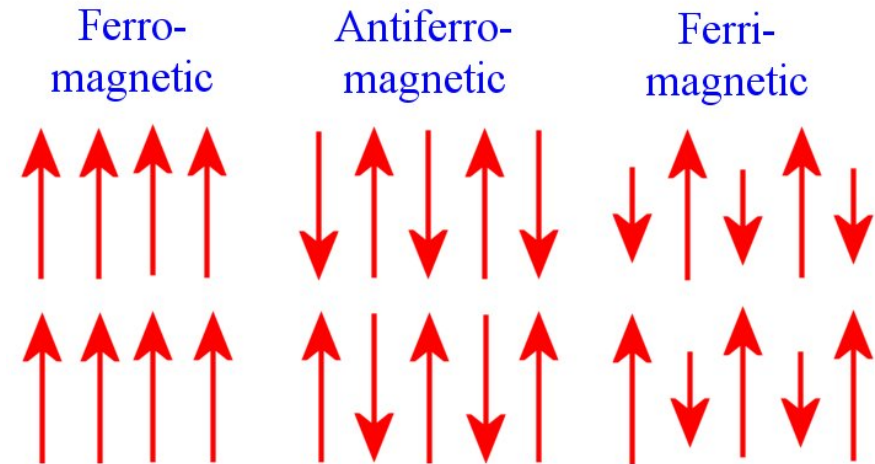

## 10.10 Other types of magnetic ordering

- ▶ The three easiest types of magnetic ordering to visualise are
  1. ferromagnetic (all spins aligned parallel)
  2. antiferromagnetic (alternating spins of equal size)
  3. ferrimagnetic (alternating spins of different size, leading to nett magnetic moment)

- ▶ As the exchange integral  $J$  can have complicated dependence on direction, other orderings are possible, for example:

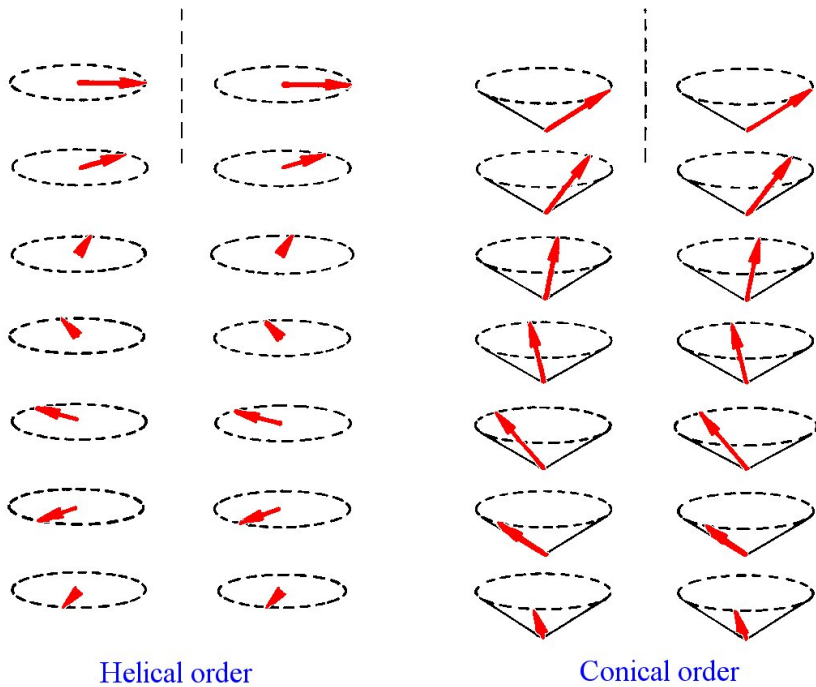

- ▶ Helical ordering (spins parallel within planes, but direction changing from plane to plane) – e.g. Dy between 90 and 180 K. Conical ordering – e.g. Eu below 50 K. Polarised neutron scattering reveals these structures.

## 10.11 Magnetic properties of metals

### 10.11.1 Free electron paramagnetism

- ▶ In a metal, the free electrons have spins, which can align in a field. As the electrons form a degenerate Fermi gas, the Boltzmann statistics we have used so far are inappropriate.

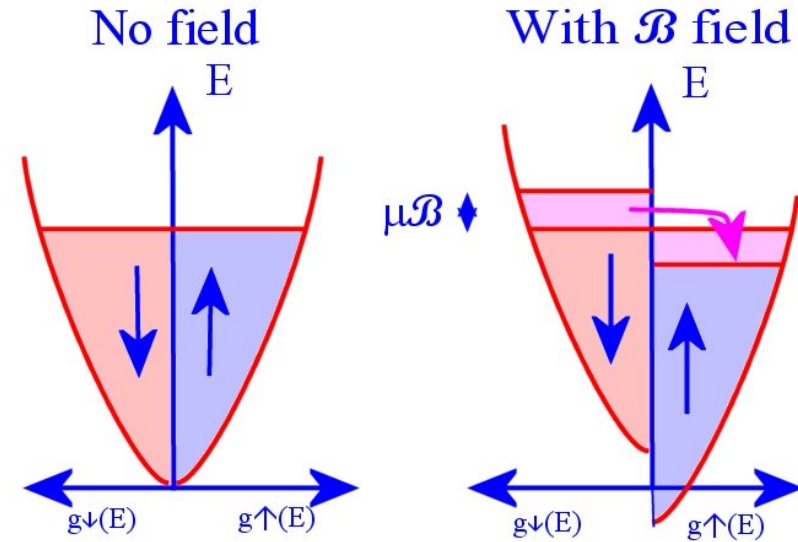

- ▶ The field  $\mathcal{B}$  will shift the energy levels by  $\pm\mu_B\mathcal{B}$ .
- ▶ Thus the number of *extra* electrons per unit volume with spin up will be

$$\Delta n_{\uparrow} = \frac{1}{2}g(E_F)\mu_B\mathcal{B}$$

and there is a corresponding change in the number with spin down,

$$\Delta n_{\downarrow} = -\frac{1}{2}g(E_F)\mu_B\mathcal{B}.$$

- ▶ The magnetisation is therefore

$$\mathcal{M} = \mu_B(n_{\uparrow} - n_{\downarrow}) = g(E_F)\mu_B^2\mathcal{B},$$

- ▶ This gives a susceptibility of

$$\chi = \frac{\mathcal{M}}{\mathcal{H}} = \mu_0\mu_B^2g(E_F) = \frac{3n\mu_0\mu_B^2}{2E_F}.$$



- ▶ This is a *temperature-independent* paramagnetism, typically of order  $10^{-6}$ .
- ▶ The free electrons also have a diamagnetic susceptibility, about  $-\frac{1}{3}$  of the paramagnetic  $\chi$ .

### 10.11.2 Ferromagnetic metals

- ▶ If we look at the periodic table we find that the ferromagnetic elements are metals.

IA																	VIII				
H	IIA															III B	IV B	V B	VIB	VIIB	He
Li	Be															B	C	N	O	F	Ne
Na	Mg	IIIA	IVA	VA	VIA	VIIA	VIIIA	IB	IIB	Al	Si	P	S	Cl	Ar						
K	Ca	Sc	Ti	V	Cr	Mn	Fe	Co	Ni	Cu	Zn	Ga	Ge	As	Se	Br	Kr				
Rb	Sr	Y	Zr	Nb	Mo	Tc	Ru	Rh	Pd	Ag	Cd	In	Sn	Sb	Te	I	Xe				
Cs	Ba	La	Hf	Ta	W	Re	Os	Ir	Pt	Au	Hg	Tl	Pb	Bi	Po	At	Rn				
Fr	Ra	Ac																			
		Ce	Pr	Nd	Pm	Sm	Eu	Gd	Tb	Dy	Ho	Er	Tm	Yb	Lu						
		Th	Pa	U	Np	Pu	Am	Cm	Bk	Cf	Es										

Antiferromagnetic  
 Ferromagnetic

- ▶ This causes some complication in the magnetic properties.
- ▶ They can be treated in a simplified way by *Stoner theory*.
- ▶ The exchange interaction splits the narrow d bands: the wide free-electron-like s bands are relatively unaffected.

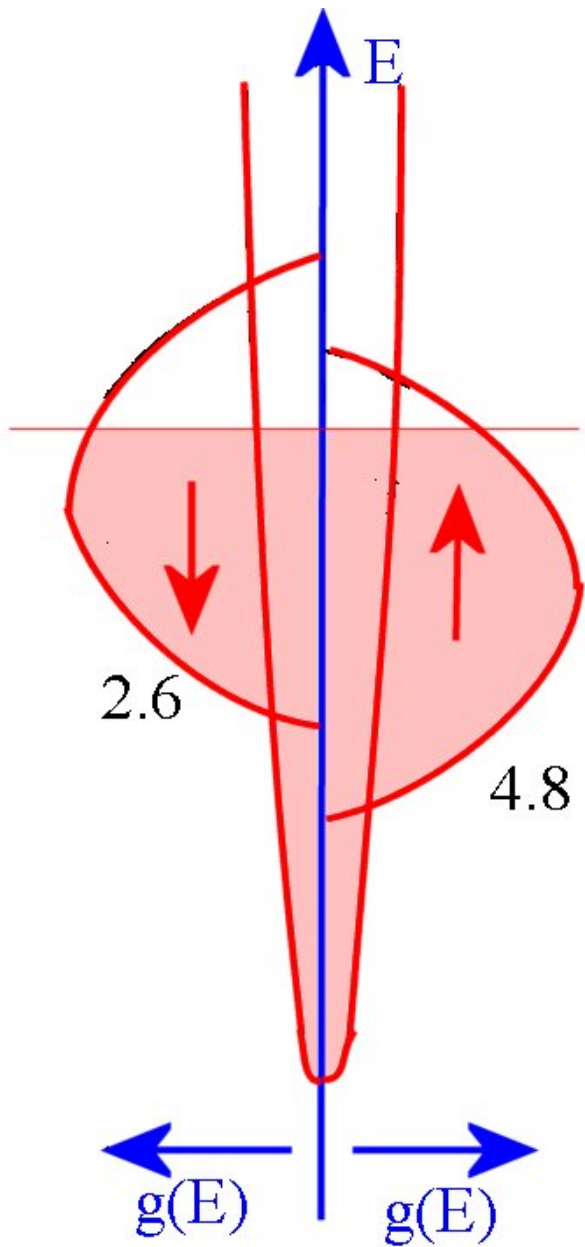

- ▶ The Fermi surface is determined by the total number of electrons: this can lead to apparently non-integer values of the magnetic moment per atom (e.g. 2.2 in Fe, 0.6 in Ni).

# Chapter 11

## Superconductivity

### 11.1 Preliminaries

#### 11.1.1 Required Knowledge

- ▶ Maxwell's equations
- ▶ Thermodynamics

#### 11.1.2 Reading

- ▶ Hook and Hall 10.1-10.6

### 11.2 Basic experimental observations

#### 11.2.1 Disappearance of resistance

- ▶ The phenomenon of superconductivity was first observed in mercury by Kammerlingh Onnes in 1911.

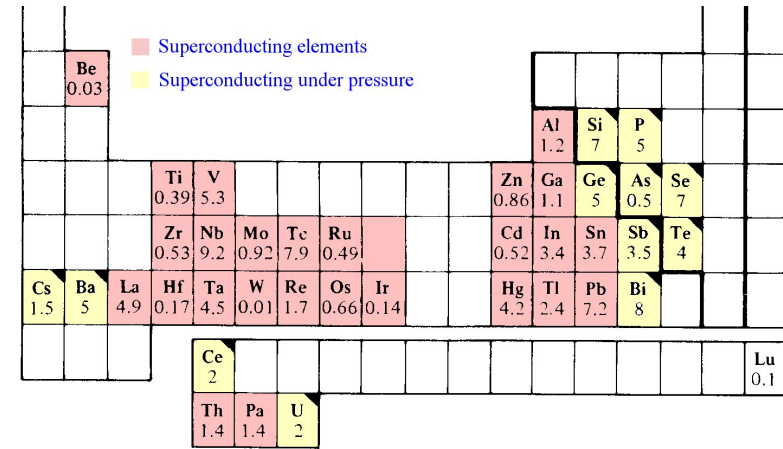
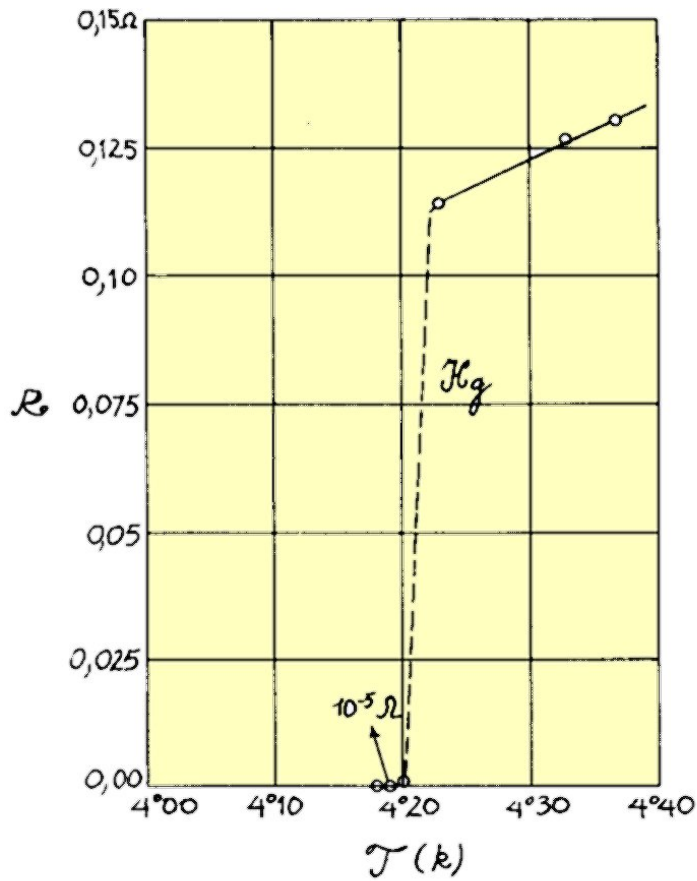

- New elements keep being added to the list: in 2002 lithium was shown to superconduct under pressures of 23 to 36 GPa with critical temperatures of 9 to 15 K<sup>1</sup>.

Element	$\rho(77K)$ m $\Omega$ m	$T_C$
Al	3	1.2
Tl	37	2.4
Sn	21	3.7
Pb	47	7.2
Sb	80	3.5
Bi	350	8
Nb	30	9.2

- There is a characteristic sharp drop in resistivity at a critical temperature,  $T_C$ .
- This effect has been observed in a wide range of elements and compounds.

- For elements in the same group, higher normal resistivity seems to go with higher transition temperature.
- For some compounds, much higher transition temperatures are found:

<sup>1</sup>V.V. Struzhkin *et al*, 2002, *Science* **298** 1213.

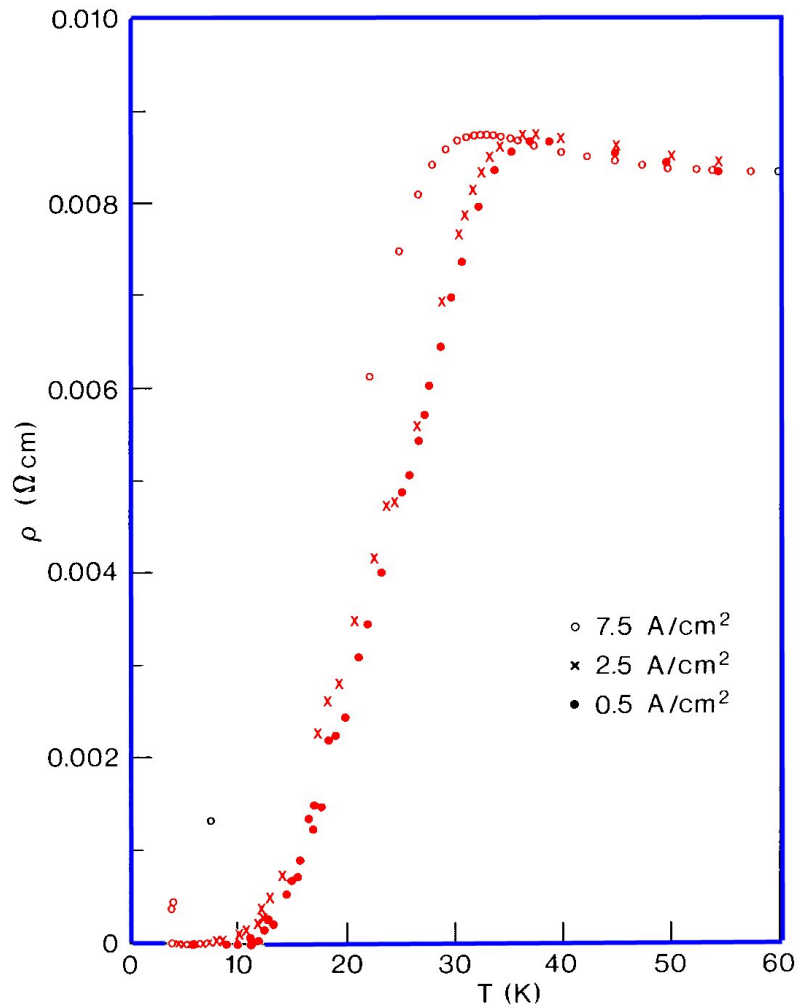

► High-temperature superconductivity found in an *insulator* by Bednorz and Müller in 1986.

► Note that the transition is not very sharp.

	$T_C$ (K)
Nb <sub>3</sub> Sn	18
Nb <sub>3</sub> Ge	23
V <sub>3</sub> Si	17
La <sub>1.8</sub> Sr <sub>0.2</sub> CuO <sub>4</sub>	35
Y <sub>0.6</sub> Ba <sub>0.4</sub> CuO <sub>4</sub>	90
Tl <sub>2</sub> Ba <sub>2</sub> Ca <sub>2</sub> Cu <sub>2</sub> O <sub>10</sub>	125
Bi <sub>1-x</sub> K <sub>x</sub> BiO <sub>3-y</sub>	27
MgB <sub>2</sub>	40

► There is also an *isotope effect*: for different isotopes of the same element in many cases

$$T_C M^{1/2} = \text{constant.}$$

► This is also found in some compounds:

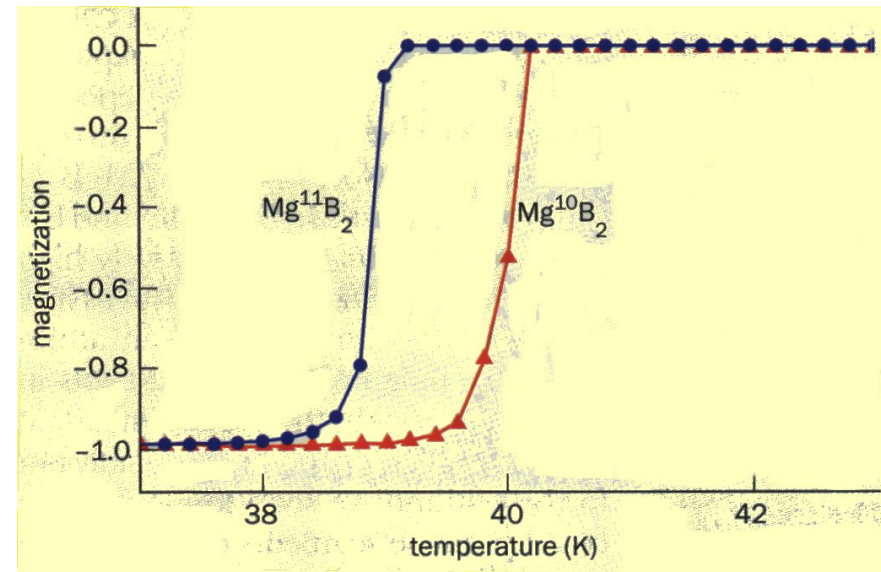

► In MgB<sub>2</sub> only the B isotope affects  $T_C$ , Mg does not.

### 11.2.2 Specific Heat

- ▶ The specific heats of normal and superconducting phases are different:

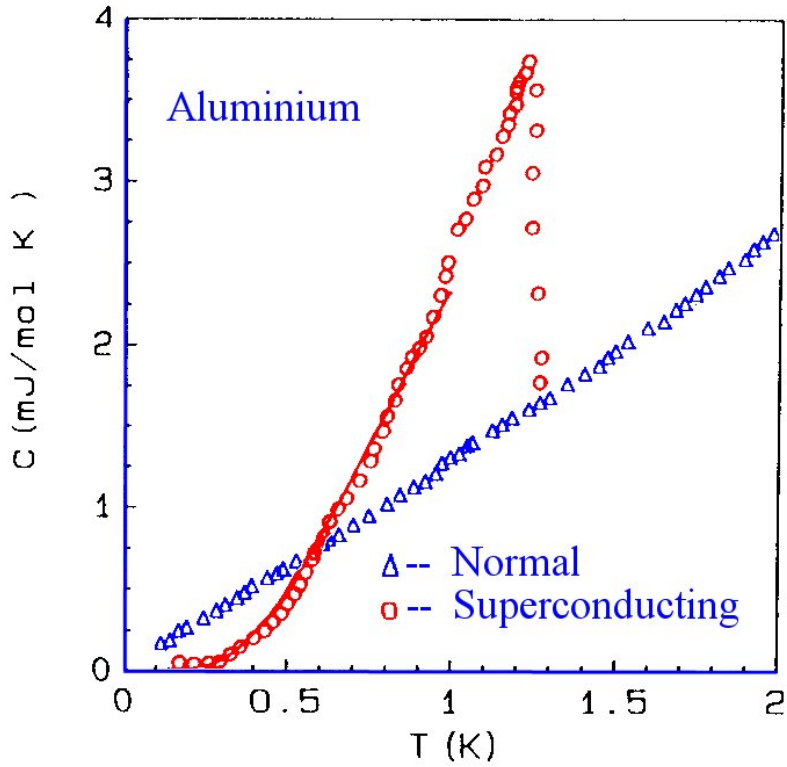

- ▶ From the specific heats, we can infer a variation of entropy with temperature<sup>2</sup>:

<sup>2</sup>Here for Sn, after Keesom and van Laer 1938)

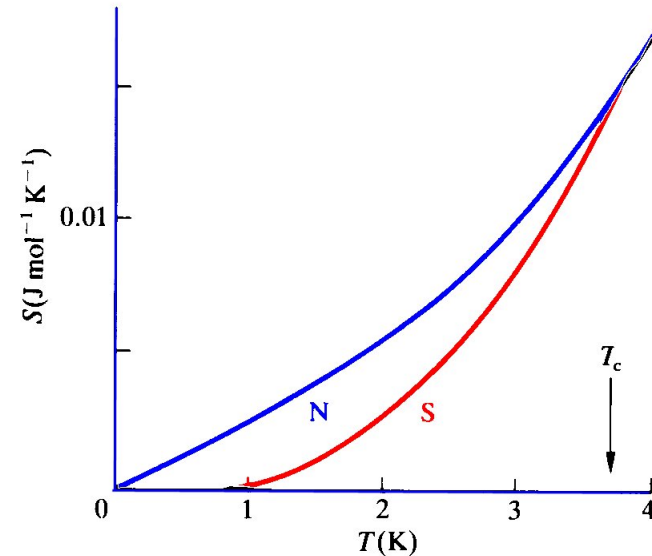

- ▶ This shows that the superconducting state is a more *ordered* state.

### 11.2.3 Effect of magnetic field

- ▶ An external magnetic field shifts  $T_C$  to lower temperatures:

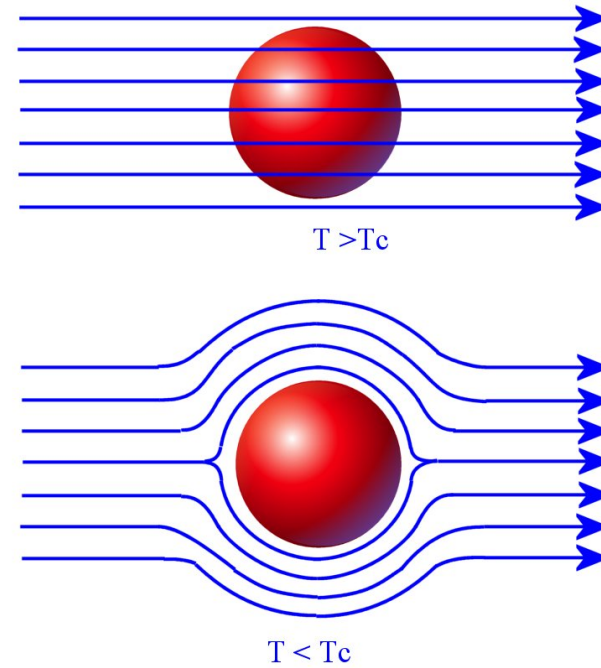
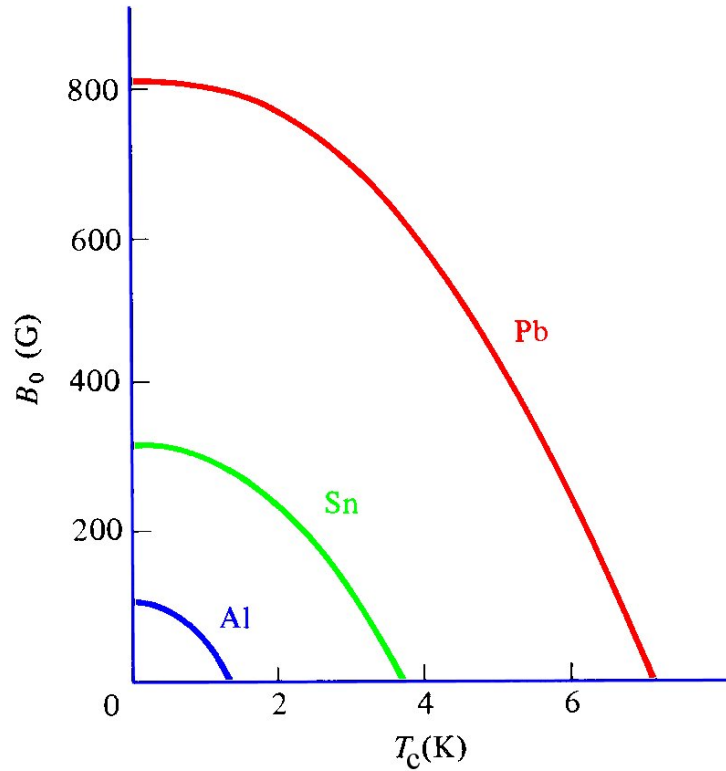

► If the flux is zero, it follows from

$$\mathcal{B} = \mu_0(\mathcal{H} + \mathcal{M})$$

that

$$\mathcal{M} = -\mathcal{H},$$

that is,

$$\chi = -1;$$

► We call this *perfect diamagnetism*.

► Note that there is a difference here between the behavior of a superconductor and a perfect conductor.

### 11.2.4 Perfect diamagnetism

► A superconductor expels magnetic flux (we will return to qualify this later) when it is cooled below its critical temperature.

▷ From Maxwell's equations we know

$$\nabla \times \mathcal{E} = -\frac{\partial \mathcal{B}}{\partial t}$$

▷ But a perfect conductor can support no electric field (even with finite current density  $\mathcal{J}$ , if the resistivity is zero  $\mathcal{E} = \rho \mathcal{J}$  is zero).

▷ If  $\mathcal{E}$  is zero, so is  $\nabla \times \mathcal{E}$ : in other words, for a perfect conductor the flux density  $\mathcal{B}$  cannot change with time (any flux present when the material becomes perfectly conducting will be locked in).

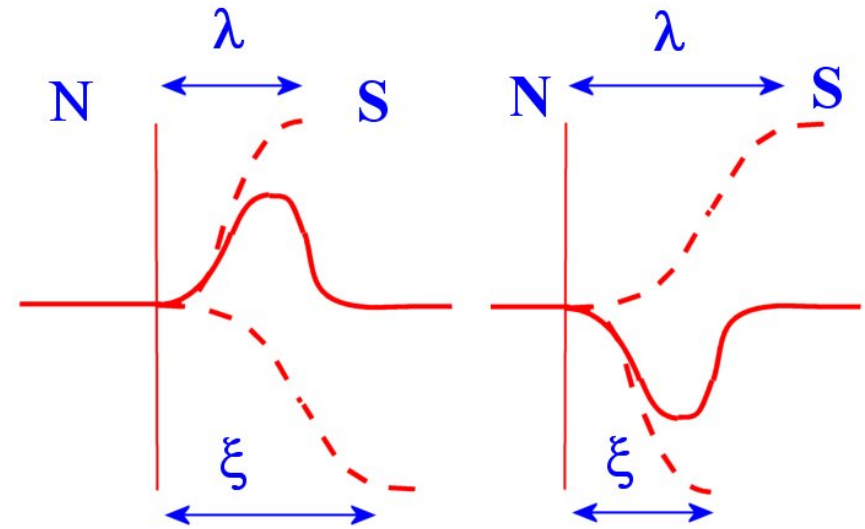

▶ N.B think of rod, not sphere – field distortion effects (demagnetisation).

▶ The magnetisation behaves in two different ways:

1. Type I reverts suddenly to a normal material at a critical field  $\mathcal{H}_c$
2. Type II begins to revert at  $\mathcal{H}_{c1}$  and the change is complete by  $\mathcal{H}_{c2}$

### 11.3 Basic thermodynamics

▶ Consider the Gibbs free energy  $G(\mathcal{B}, T)$ . We know that

$$dG = -SdT - \mathcal{M}.d\mathcal{B},$$

so that the perfect diamagnetism in a field  $\mathcal{B}$  increases the free energy by

$$\frac{\mathcal{B}^2}{2\mu_0}.$$

Thus

$$G_S(\mathcal{B}, T) = G_S(0, T) + \frac{\mathcal{B}^2}{2\mu_0}.$$



- ▶ In the normal state the magnetic field has negligible effect (because the field energy with a susceptibility  $\chi \approx \pm 10^{-6}$  is tiny compared with that of the perfect diamagnet with  $\chi = -1$ )

$$G_N(\mathcal{B}, T) \approx G_N(0, T).$$

- ▶ At the critical field,  $\mathcal{B}_C$ , the free energies of the superconducting and normal states are equal

$$\begin{aligned} G_S(\mathcal{B}_C, T) &= G_S(0, T) + \frac{\mathcal{B}_C^2}{2\mu_0} \\ &= G_N(\mathcal{B}_C, T) \\ &= G_N(0, T), \end{aligned}$$

so

$$G_S(0, T) = G_N(0, T) - \frac{\mathcal{B}_C^2}{2\mu_0},$$

- ▶ The critical field is a measure of the stability of the superconducting state.
- ▶ In an applied field  $\mathcal{B} < \mathcal{B}_C$ ,

$$G_S(\mathcal{B}, T) = G_N(0, T) - \frac{\mathcal{B}_C^2 - \mathcal{B}^2}{2\mu_0}. \quad (11.1)$$

### 11.3.1 Specific heat

- ▶ At constant  $p$  and  $\mathcal{B}$  the entropy is given by

$$S = -\frac{\partial G}{\partial T},$$

- ▶ Using equation 11.1,

$$\begin{aligned} S_S - S_N &= \frac{d}{dT} \left( \frac{\mathcal{B}_C^2 - \mathcal{B}^2}{2\mu_0} \right) \\ &= \frac{\mathcal{B}_C}{\mu_0} \frac{d\mathcal{B}_C}{dT}. \end{aligned}$$

- ▶ As the specific heat is

$$C = T \frac{dS}{dT}$$

we get

$$\begin{aligned} C_S - C_N &= T \frac{d}{dT} \frac{\mathcal{B}_C}{\mu_0} \frac{d\mathcal{B}_C}{dT} \\ &= \frac{T}{\mu_0} \left[ \left( \frac{d\mathcal{B}_C}{dT} \right)^2 + \mathcal{B}_C \frac{d^2\mathcal{B}_C}{dT^2} \right]. \end{aligned}$$

- ▶ When  $T = T_C$ , the critical field  $\mathcal{B}_C$  is zero, so

$$C_S(T_C) - C_N(T_C) = \frac{T}{\mu_0} \left( \frac{d\mathcal{B}_C}{dT} \right)^2.$$

- ▶ This gives an explanation of the observed specific heat discontinuity.
- ▶ Note that in an order-disorder transition such as this there is no latent heat at the critical temperature.

### 11.3.2 The shielding currents

- ▶ The mechanism for excluding flux from the superconductor involves inducing currents in the surface.
- ▶ Of course, if the exclusion were perfect and occurred exactly at the surface this would imply infinite current density at the surface, which is unphysical. So we need to look rather more closely at the electromagnetism.
- ▶ Suppose that  $n$  charge carriers per volume, each with charge  $q$  and mass  $m$ , are continuously accelerated by a field

$$\frac{d\mathbf{v}}{dt} = \frac{q\mathcal{E}}{m},$$

but the current is

$$\mathcal{J} = nq\mathbf{v},$$

so

$$\mathcal{E} = \frac{m}{nq^2} \frac{d\mathcal{J}}{dt}.$$

- ▶ Now

$$\nabla \times \mathcal{H} = \mathcal{J},$$

or

$$\nabla \times \mathcal{B} = \mu_0 \mathcal{J},$$

so

$$\mathcal{E} = \frac{m}{n\mu_0 q^2} \nabla \times \frac{d\mathcal{B}}{dt}.$$

- ▶ Now take the curl of both sides

$$\nabla \times \mathcal{E} = \frac{m}{n\mu_0 q^2} \nabla \times \nabla \times \frac{d\mathcal{B}}{dt},$$

- ▶ Recall the identity

$$\nabla \times \nabla \times = \nabla(\nabla \cdot) - \nabla^2,$$

and the Maxwell equations

$$\nabla \times \mathcal{E} = -\frac{\partial \mathcal{B}}{\partial t},$$

and

$$\nabla \cdot \mathcal{B} = 0$$

- ▶ Thus

$$\frac{d\mathcal{B}}{dt} = \frac{m}{n\mu_0 q^2} \nabla^2 \frac{d\mathcal{B}}{dt}.$$

- ▶ We can write this as

$$\frac{d\mathcal{B}}{dt} = \lambda^2 \nabla^2 \frac{d\mathcal{B}}{dt}, \tag{11.2}$$

with

$$\lambda = \sqrt{\frac{m}{nq^2 \mu_0}}.$$

- ▶ One solution of equation 11.2 is

$$\frac{d\mathcal{B}}{dt} = A e^{-x/\lambda},$$

- ▶ Thus we can see that there is an exponential decay of the magnetic field within the surface of the perfect conductor.
- ▶ We call  $\lambda$  the *penetration depth*, and find that it is typically about  $10^{-8}$  m.

## 11.4 Phenomenological theories

- By showing that

$$\frac{d\mathcal{B}}{dt} = Ae^{-x/\lambda}$$

we have still not established a difference between a perfect conductor and a superconductor: it is only the *rate of change* of  $\mathcal{B}$  that we have shown to decay within the material.

- The brothers F. and H. London suggested, in 1935, that a superconductor should obey the equation

$$\nabla \times \mathcal{J} = -\frac{nq^2}{m}\mathcal{B} \quad (11.3)$$

in addition to the equation for non-scattered carriers

$$\frac{d\mathcal{J}}{dt} = \frac{nq^2}{m}\mathcal{E}. \quad (11.4)$$

- Then, as before, take the curl of both sides of Maxwell's equation (with no displacement currents)  $\nabla \times \mathcal{H} = \mathcal{J}$ .

$$\nabla \times \mathcal{H} = \mathcal{J}$$

gives

$$\nabla \times \nabla \times \mathcal{B} = \mu_0 \nabla \times \mathcal{J}$$

whence, as  $\nabla \times \nabla \times = \nabla(\nabla \cdot) - \nabla^2$ , we have

$$-\nabla^2 \mathcal{B} = \mu_0 \nabla \times \mathcal{J}$$

- From equation 11.3  $\nabla \times \mathcal{J} = -(nq^2/m)\mathcal{B}$ ,

$$\nabla^2 \mathcal{B} = \frac{\mu_0 nq^2}{m} \mathcal{B}.$$

- Then, with

$$\lambda = \sqrt{\frac{m}{\mu_0 nq^2}},$$

we have

$$\mathcal{B}(x) = \mathcal{B}(0)e^{-x/\lambda}.$$

- Similarly

$$\mathcal{J}(x) = \mathcal{J}(0)e^{-x/\lambda}.$$

- Now we have a decay of the *static* field.

- Note that the London equations do not allow a uniform non-zero field inside the material: if the field inside is constant it must be zero.

- If we assume that *all* the electrons are involved in the unscattered current, we find  $\lambda \approx 10^{-8}$  to  $10^{-7}$  m, the London penetration depth.

### 11.4.1 Measurement of penetration depth

- If all flux were excluded from a superconductor, there would be no flux linkage between two coils wound on a superconducting core.
- As there is flux throughout the penetration region,  $\lambda$  can be measured by measuring the mutual inductance of the coils.

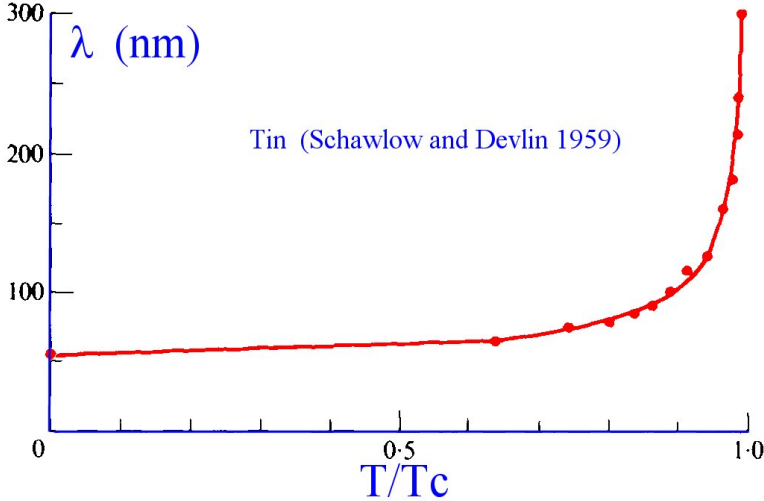

- Many experiments show that  $\lambda$  varies with temperature, to a good approximation, as

$$\lambda(T) = \frac{\lambda(0)}{\sqrt{1 - \left(\frac{T}{T_C}\right)^4}}$$

- Recalling that

$$\lambda = \sqrt{\frac{m}{\mu_0 n q^2}}$$

this suggests that the number of non-scattering carriers varies as

$$1 - \left(\frac{T}{T_C}\right)^4$$

### 11.5 Coherence

- Unfortunately, experiment showed that the penetration depth does not just depend on  $T$ , but also on impurities.
- Penetration depth and normal electron mean free path are related.

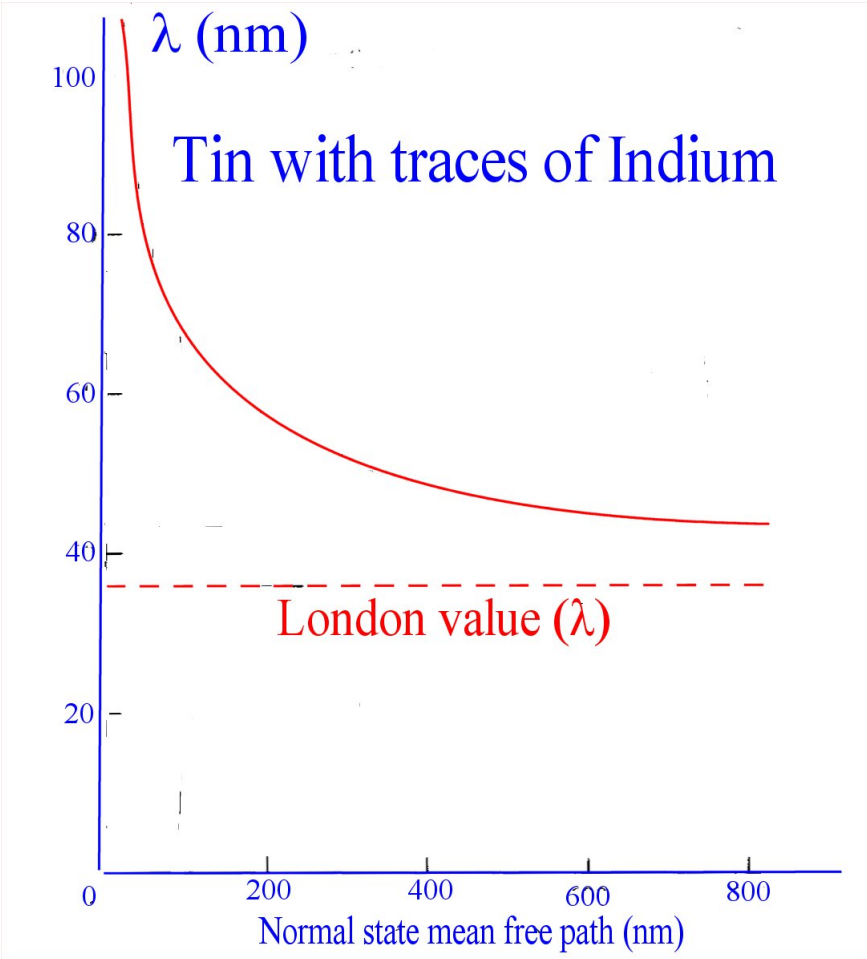

- ▶ Pippard suggested that the superconducting state was one of *long-range order* over some *coherence length*,  $\xi$ .
- ▶ Evidence for this includes:
  - ▷ The sharpness of the superconducting transition. If electrons were individually going into some new state there would be statistical fluctuations giving broader transitions.
  - ▷ The penetration depth dependence on mean free path. Assume that we can only determine the *average* superconducting current over a volume  $\xi^3$ . Then
    - ▷ *long mean free path and large  $\xi$* : averaging gives non-local relationship between  $\mathcal{B}$  and  $\mathcal{J}$ .
    - ▷ *impure materials* with  $\xi \approx$  mean free path have greatly increased  $\lambda$
    - ▷ *small  $\xi$*  recovers original local model for  $\lambda$ .

## 11.6 Microscopic model

- ▶ In 1957 Bardeen, Cooper and Schrieffer put together the clues to provide the BCS theory of superconductivity<sup>3</sup>.

<sup>3</sup>John Bardeen was the first person to receive two Nobel prizes in the same field. He shared the 1956 prize for physics with William Shockley and Walter Brattain for the discovery of the transistor effect, and the 1972 prize with Leon Cooper and John Schrieffer for their theory of superconductivity

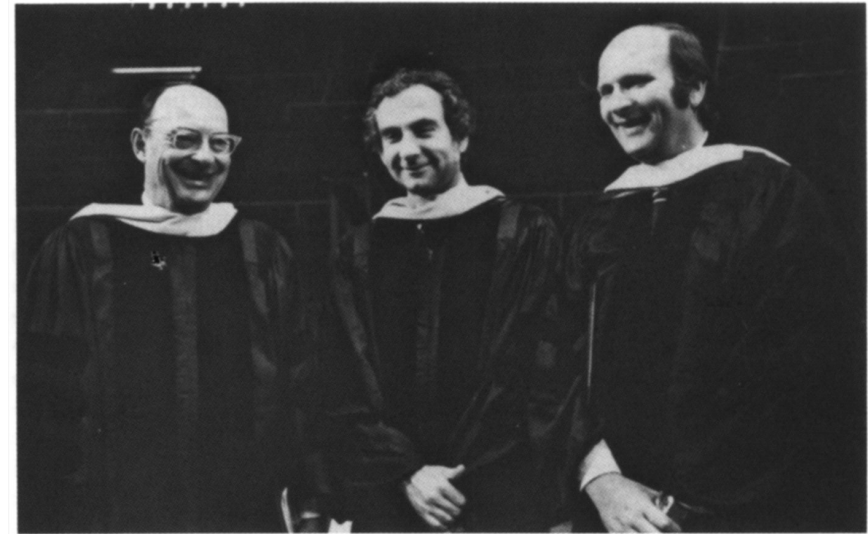

John Bardeen (b. 1908), Leon N. Cooper (b. 1930), and John Robert Schrieffer (b. 1931).  
(AIP Niels Bohr Library)

- ▶ Cooper took the first step in 1956 by showing that if two electrons are added to the ground state of the free electron gas (filled states up to  $E_F$  they will form a bound state ( $E < 2E_F$ ) if there is an attractive potential *however small* between them.
- ▶ If there is an attractive interaction of strength  $V$  between electrons in an energy range  $\hbar\omega$  above  $E_F$ , then their energy will be reduced by
 
$$\Delta = -2\hbar\omega e^{-2/(g(E_F)V)},$$
 provided that  $g(E_F)V$  is small.
- ▶  $\Delta$  is typically about 1 meV.
- ▶ The  $V$  in the denominator of the exponential shows that any attempts to predict superconductivity using perturbation theory were doomed to failure.

- ▶ The bound pair (Cooper pair) has opposite values of  $k$  and opposite spins.
- ▶ Cooper's discovery could be linked with Fröhlich's (1950) suggestion that
  - ▷ an electron moving through the positively charged ion cores will displace them slightly from their normal positions
  - ▷ this local increase in positive charge density attracts another electron.
- ▶ Alternative explanation in terms of *virtual phonons*.

- ▶ The phonon is absorbed by another electron
- ▶ This may change the energy of the electrons, if

$$|\mathbf{k}|^2 + |\mathbf{k}'|^2 \neq |\mathbf{k} + \mathbf{q}|^2 + |\mathbf{k}' - \mathbf{q}|^2.$$

- ▶ As phonon frequencies  $\omega \propto \sqrt{\kappa/M}$  for force constant  $\kappa$  and mass  $M$  this is consistent with the isotope effect

### 11.6.1 The energy gap

- ▶ The effect of the interaction is to ensure that within  $\Delta$  of the Fermi surface there are no occupied states.
- ▶ The density of states immediately above and below the gap is increased correspondingly.

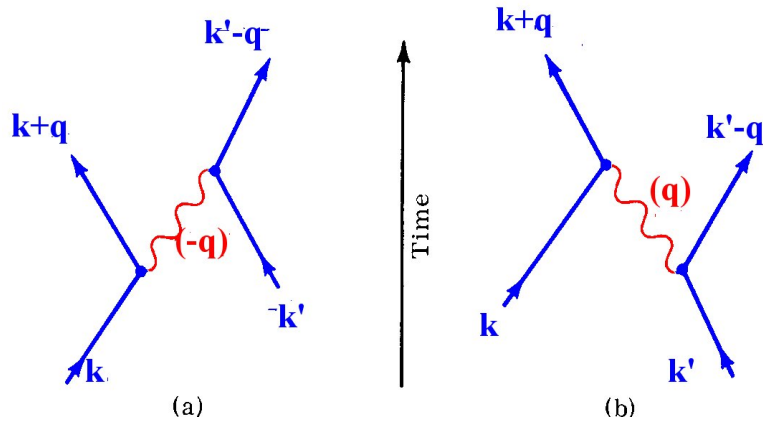

- ▶ An electron with wavevector  $k$  emits a phonon with wavevector  $q$
- ▶ If the phonon is rapidly absorbed by another electron in time  $\Delta t$  the uncertainty relation  $\Delta E \Delta t \geq \hbar$  lets us 'borrow' energy  $\Delta E$

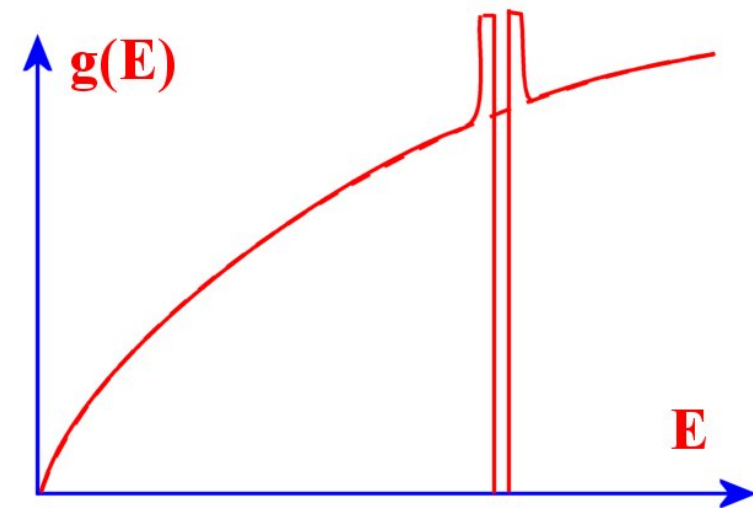

- ▶ The gap is  $2\Delta$  wide. The Fermi energy is in the middle of the gap.
- ▶ An energy  $2\Delta$  will break up a pair and create two ‘normal’ electrons.
- ▶ The pairs have many of the properties of bosons.

### 11.6.2 The wavefunction

- ▶ The wavefunction for the paired electrons corresponds to electrons with energies within  $\Delta$  of  $E_F$ . Now

$$\Delta = \delta E = \delta \left( \frac{\hbar^2 k^2}{2m} \right) \approx \left( \frac{\hbar k_F}{m} \right) \hbar \delta k.$$

- ▶ If we assume that the spread of the wavefunction is determined by the uncertainty relation,

$$\xi \delta(\hbar k) \approx \hbar,$$

we find

$$\xi \approx \frac{1}{\delta k} \approx \frac{\hbar k_F}{m\Delta} \approx \frac{1}{k_F} \frac{E_F}{\Delta},$$

and putting in typical values of  $E_F/\Delta \approx 10^3$ ,  $k_F \approx 10^{10} \text{ m}^{-1}$ ,  $\xi \approx 10^{-7} \text{ m}$ .

- ▶ Note that  $\xi$  can be large compared with the London penetration depth.
- ▶ Within the coherence length there are millions of Cooper pairs, and the energy is minimized when they have the same phase. (This is the ordering.)

- ▶ Often write the superconducting wavefunction as

$$\psi(\mathbf{r}) = \sqrt{n_s(\mathbf{r})} e^{i\theta(\mathbf{r})} :$$

where  $n_s(\mathbf{r})$  is the density of pairs and  $\theta(\mathbf{r})$  describes a spatially varying phase.

- ▶ Minimising the free energy one finds the critical temperature is given by

$$k_B T_C = 1.14 \hbar \omega e^{-2/(g(E_F)V)},$$

so

$$2\Delta = 3.52 k_B T_C.$$

- ▶ The BCS theory predicts temperature variations of the energy gap near  $T_C$ :

$$\frac{\Delta(T)}{\Delta(0)} = 1.74 \left( 1 - \frac{T}{T_C} \right)^{1/2}$$

and the critical field

$$\frac{\mathcal{H}_C(T)}{\mathcal{H}_C(0)} = 1 - \left( \frac{T}{T_C} \right)^2.$$

# 11.7 Experimental evidence for energy gap 11.7.2 Infrared absorption gap

## 11.7.1 Specific heat

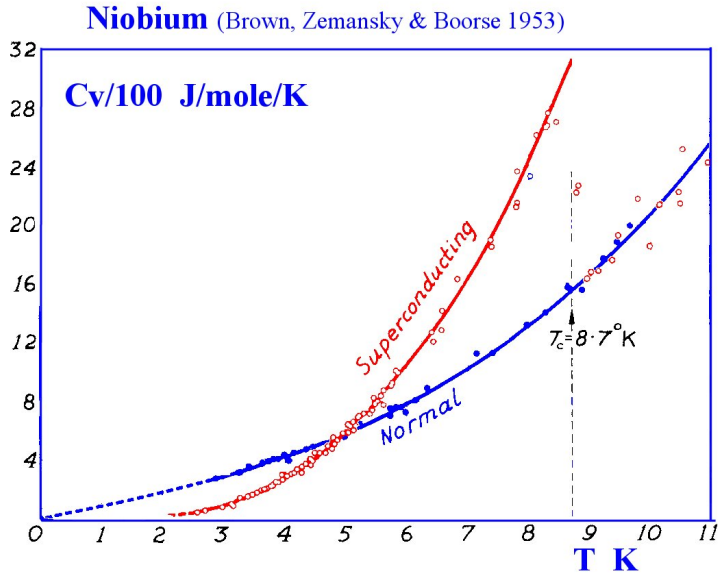

► Number of electrons contributing to specific heat varies as

$$e^{-\Delta/(k_B T)}$$

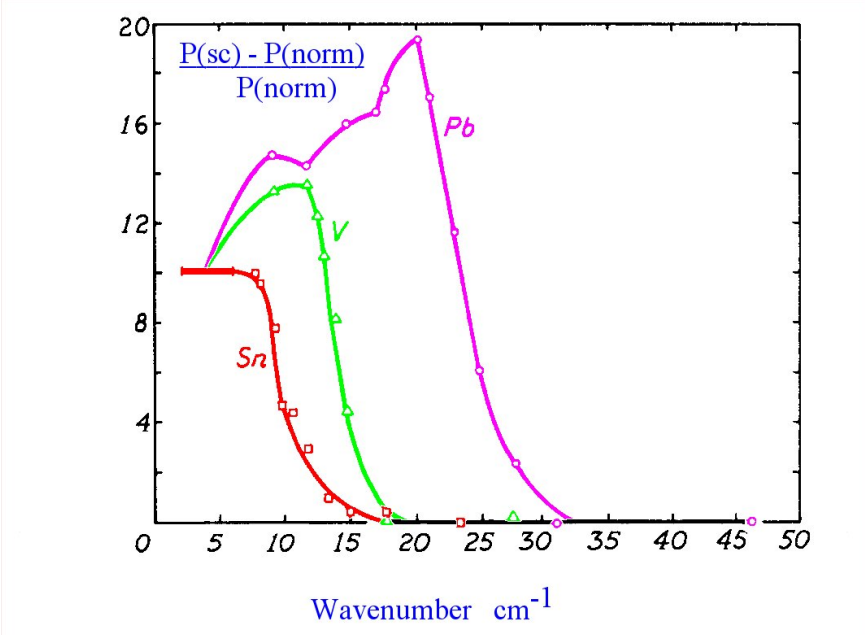



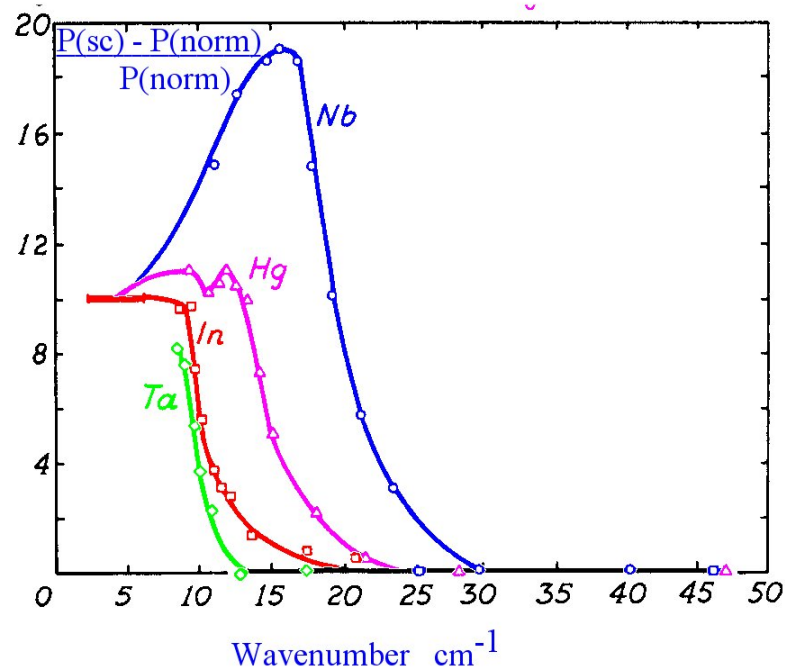

► Values of energy gap deduced from infrared absorption (Richards and Tinkham 1960).

Metal	Threshold (cm <sup>-1</sup> )	T <sub>C</sub>	2Δ/k <sub>B</sub> T <sub>C</sub>
Ta	10	4.482	3.0
Nb	20	9.5	2.9
V	15	5.38	3.8
Pb	25	7.193	4.7
Sn	10	3.722	3.7
Hg	15	4.153	4.9
In	11	3.404	4.4

► These results are in reasonable agreement with  $2\Delta = 3.52k_B T_C$ .

### 11.8 Tunnelling currents

- Put two materials together with a very thin insulating layer between (often just an oxide layer) through which normal electrons can tunnel.
- Two normal metals - linear  $I - V$  relation.

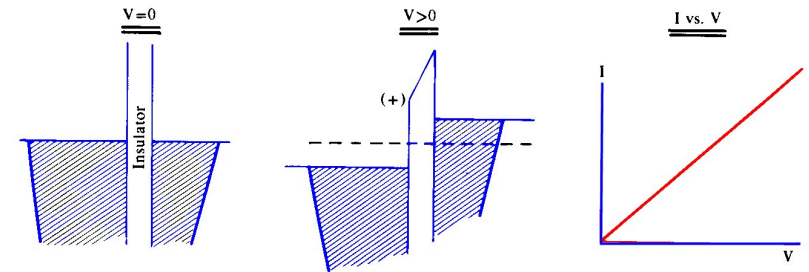

► Superconductor-normal.

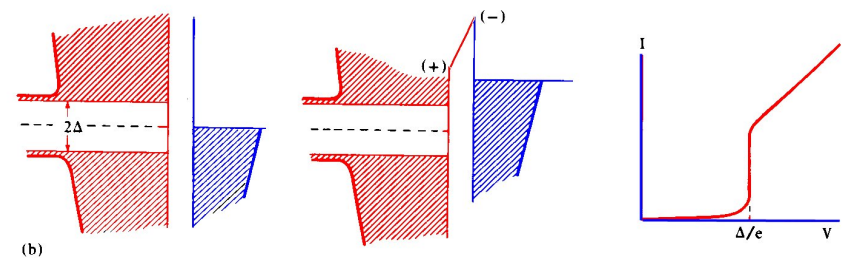

► With no bias, there are no empty states to which electrons in the normal metal can pass.

► Superconductor-superconductor

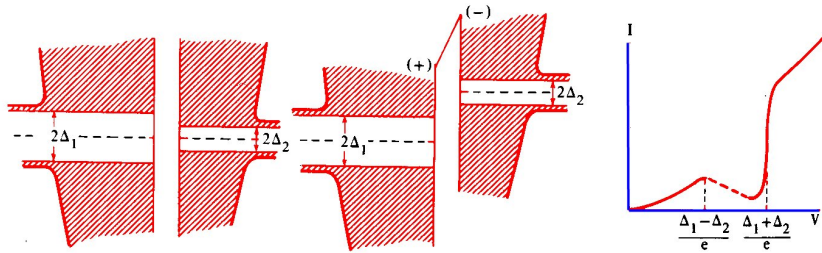

► Small initial current from small number of excited electrons in material with smaller gap.

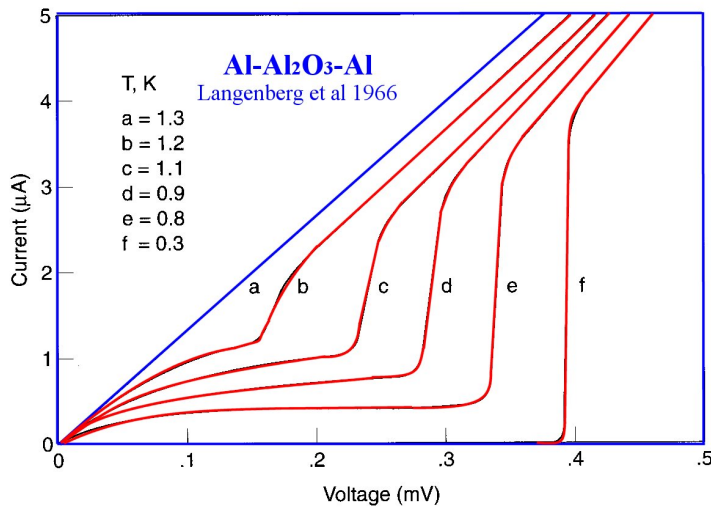

► The threshold voltages allow us to measure  $\Delta$ .

11.8.1 Type I and type II behaviour

- When we apply a field, two effects compete: electron pairing reduces the free energy, whilst field penetration increases it.
- Each effect has a characteristic length scale:  $\lambda$  for flux penetration and  $\xi$  for pairing.
- At a phase boundary:

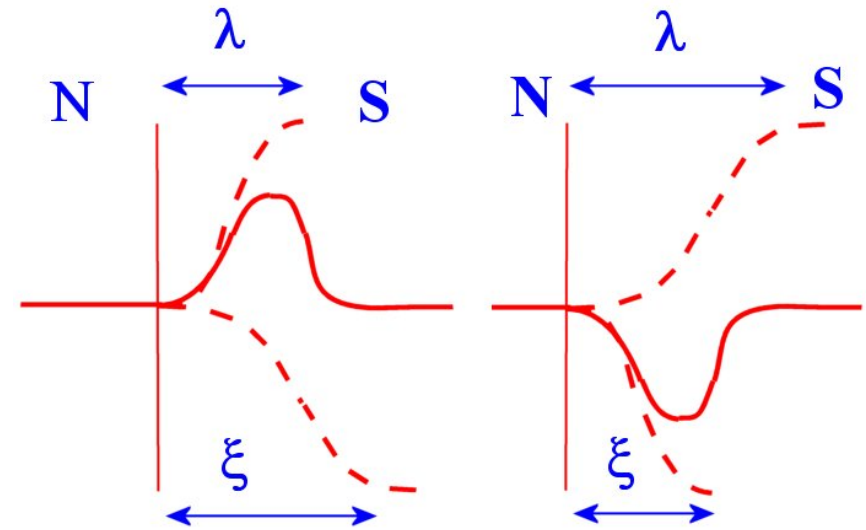

- ▷ Type I:  $\lambda < \xi$  gives positive surface energy
- ▷ Type II:  $\lambda > \xi$  gives negative surface energy

► In Type II material lines of flux can penetrate one by one:

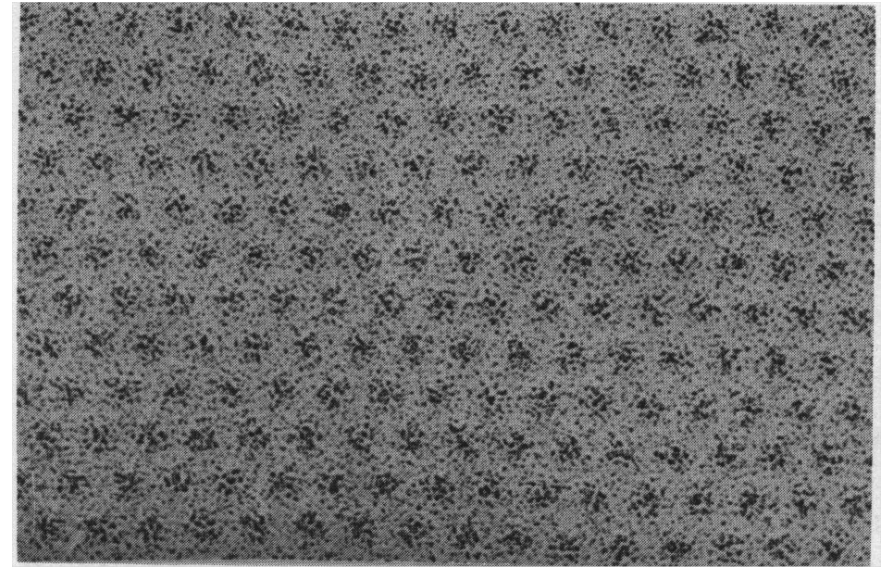
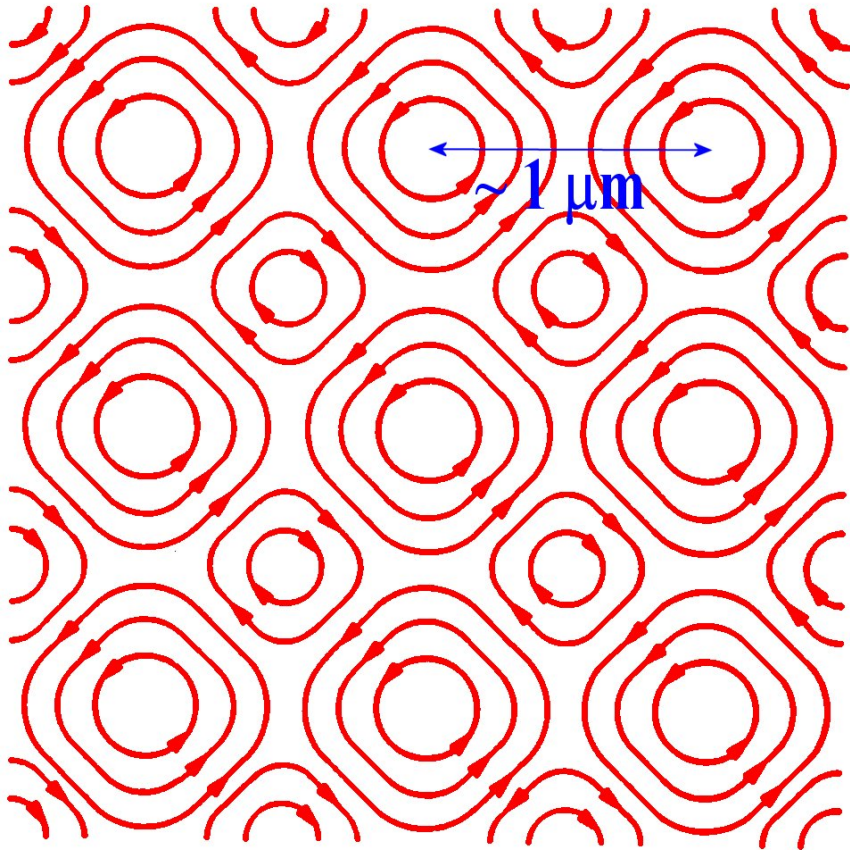

## 11.9 High $T_C$ materials

► [Chiranjib Mitra]

► At the centre of each vortex of current is a normal region containing one quantum of magnetic flux,  $h/(2e)$ .

► Vortex lines in  $\text{Pb}_{0.98}\text{In}_{0.02}$  film in a magnetic field.